

Multi-Contact

MC

STÄUBLI

CombiTac Main catalog

CombiTacline | Industrial Connectors



STÄUBLI ELECTRICAL CONNECTORS

Long-term solutions – Expert connections



Stäubli Electrical Connectors is a leading international manufacturer of high-quality electrical connector systems. We are part of the Stäubli Group which offers mechanics solutions for electrical connectors, liquid and gas couplings, robots and textile machinery.

Stäubli develops, produces, sells and maintains products for markets with high productivity standards. As recognized specialists, our focus is always on solutions and customers. Many new developments got their start here and have begun to make their way around the world.

Businesses and customers count on our commitment and our active support when dealing with unusual problems. With us, you are entering into a long-term partnership built on reliability, dynamism, and exceptional quality in both products and services.

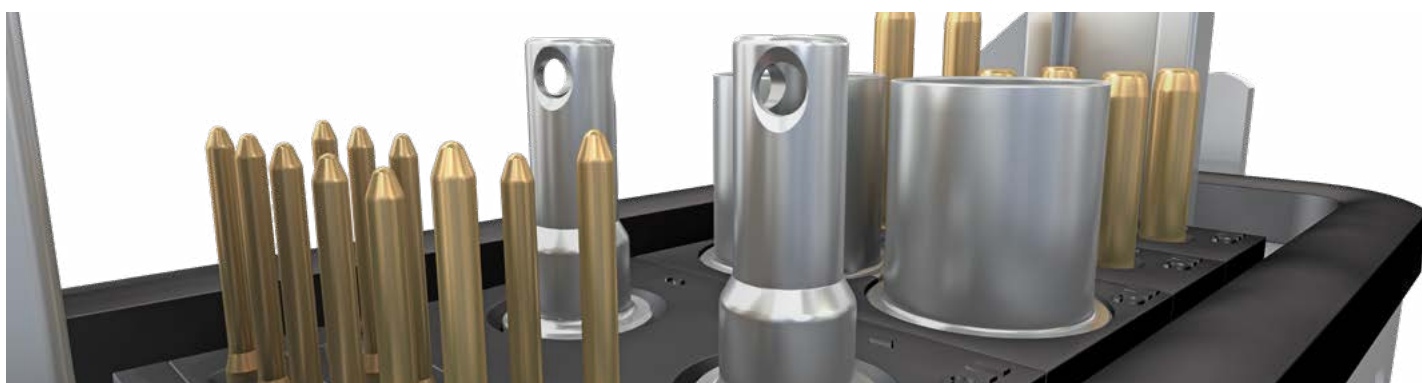

Applications and advantages



The CombiTac modular connector system combines power, signals, data, fiber-optics, pneumatic and fluid connections in a single frame or housing.

It is used in demanding applications that need versatile long life modular connector solutions: automatic production line equipment, machinery, robots, laboratory test equipment, railway battery connector systems and many more.

Thanks to the tried and tested MULTILAM Technology, CombiTac contacts can achieve up to 100'000 mating cycles and reach current levels up to 300 A.

As a solutions provider, we offer our customers extensive A-Z support in designing their own 100 % customized CombiTac, designed and adapted to meet exact specifications

- High rated current and short circuit carrying capacity
- High resistance to shock and vibrations
- Reconfigurable and expandable modular system
- 100 % customizable
- Supplied complete with cable assembly upon request

Further information concerning product portfolio, special features as well as exemplary videos can be found at www.combitac.com

Content

| | | | |
|----------------|--|-----------------|--|
| Page 6 | Introduction | Page 42 | Data transfer unit |
| | | | <ul style="list-style-type: none"> ▪ CAT5 Ethernet, IEEE802.3, Profibus, Profinet, Interbus, CAN-BUS ▪ 10Gbit module CAT6A Ethernet IEEE 802.3an ▪ RJ45 Data Transfer Unit CAT5 Ethernet IEEE802.3 |
| Page 8 | Ø 12 mm Power unit | | |
| | <ul style="list-style-type: none"> ▪ Up to 300 A, 1000 V ▪ For details on see page 115 | | |
| Page 16 | Ø 8 mm Power unit | Page 48 | Optical fiber unit POF |
| | <ul style="list-style-type: none"> ▪ Up to 150 A, 1000 V ▪ For details on see page 115 | | <ul style="list-style-type: none"> ▪ (Plastic optical fiber) |
| Page 18 | Ø 6 mm, Ø 8 mm Power unit | Page 50 | Optical fiber unit GOF |
| | <ul style="list-style-type: none"> ▪ Up to 125 A, 150 A, 1000 V ▪ For details on see page 115 | | <ul style="list-style-type: none"> ▪ (Glass optical fiber) |
| Page 20 | Ø 6 mm Power unit | Page 52 | Thermocouple unit |
| | <ul style="list-style-type: none"> ▪ Up to 120 A, 1000 V ▪ For details on see page 115 | Page 56 | Pneumatic and fluid units |
| Page 22 | Ø 3 mm Power unit | | <ul style="list-style-type: none"> ▪ Compressed air – vacuum unit ▪ Coolant unit |
| | <ul style="list-style-type: none"> ▪ Up to 40 A, 1000 V ▪ For details on see page 115 | Page 68 | Single parts for CombiTac frames |
| Page 26 | Ø 3 mm High voltage unit | Page 69 | Calculation of installation dimensions |
| | <ul style="list-style-type: none"> ▪ Up to 5 kV, 32 A | Page 70 | Panel mounted |
| Page 28 | Ø 1.5 mm Signal unit | Page 72 | DIN housings for CombiTac |
| | <ul style="list-style-type: none"> ▪ Up to 19 A, 600 V ▪ For details on see page 115 | | <ul style="list-style-type: none"> ▪ Coding ▪ Calculation of housing size ▪ Spacers ▪ Aluminum DIN housings ▪ Plastic DIN housing |
| Page 30 | Ø 1 mm Signal unit | Page 92 | Protective grounding of conductive housings |
| | <ul style="list-style-type: none"> ▪ Up to 12 A, 300 V ▪ For details on see page 115 | Page 98 | Light housing for testing applications |
| Page 34 | Ø 0.6 mm Signal unit | Page 100 | Crimping pliers |
| | <ul style="list-style-type: none"> ▪ Up to 6 A, 150 V | Page 102 | Assembly tools |
| Page 36 | Last Mate First Break module | Page 104 | Appendix |
| | <ul style="list-style-type: none"> ▪ | | <ul style="list-style-type: none"> ▪ Derating diagrams ▪ Technical information ▪ Index |
| Page 38 | Coaxial unit 6 GHz | | |
| | <ul style="list-style-type: none"> ▪ | | |
| Page 40 | Coaxial unit 1.5 GHz | | |
| | <ul style="list-style-type: none"> ▪ | | |

General information

Changes / provisos

All data, illustrations, and drawings in the catalog have been carefully checked. They are in accordance with our experience to date, but no responsibility can be accepted for errors.

We also reserve the right to make modifications for design and safety reasons. When designing equipment incorporating our components, it is therefore advisable not to rely solely on the data in the catalog but to consult us to make sure this information is up to date. We shall be pleased to advise you.

Copyright

The use of this catalog for any other purpose, in whatever form, without our prior written consent is not permitted.

RoHS ready

All CombiTac parts comply with Directive 2011/65/EC on the restriction of the use of certain hazardous substances in electrical and electronic equipment.

Symbols



Accessories or special tools exist for this product

www.staubli.com/electrical



Before use, please read the enclosed RZ Sheet

www.staubli.com/electrical



The assembly instructions MA000 are available for this product

www.staubli.com/electrical



Surface Ag



Surface Au

Abbreviations

| | |
|-----|-----------------------------|
| S | = Screw termination |
| PCB | = Flow soldered termination |
| C | = Crimp termination |
| L | = Soldering |
| AWG | = American Wire Gauge |

Housing

| | |
|--------------|--|
| TG | = Coupler hood |
| KG | = Coupler housing |
| AG | = Surface mount housing |
| SG | = Pedestal mount housing |
| -S | = Cable inlet, side |
| -G | = Cable inlet, straight |
| -PW | = Protective wall |
| -D | = With lid |
| -PS | = Park station |
| ZV | = Central locking |
| SD-...L/FSCH | = Plastic protective cover with lanyard for metal housing IP65 |

COMBITAC

The modular connector system

DIN coupler hoods

6 different sizes

Rails

Included in delivery

May be ordered separately

End pieces in 2 versions

- Housing assembly
- Panel mounting

Included in delivery

May be ordered separately

Delivery status of the CombiTac

- Contact carriers mounted on rails
- Assembled with end pieces
- Contacts separately
- Gas and fluid couplings will be mounted in the carriers
- PCB contacts will be mounted on request

Possible connections

- Electric
- Thermocouple pressure contacts
- Coaxial
- Optical fiber
- Compressed air
- Liquid
- Electric + PE
- Data transfer

Fully assembled CombiTac connector with connecting lines

On request

DIN surface and pedestal mount housing

6 different sizes

Mating cycles

CombiTac as panel mounted: up to 100,000

CombiTac in housing: up to 5,000

For the connector, the lowest mating cycle value of the individual components applies.

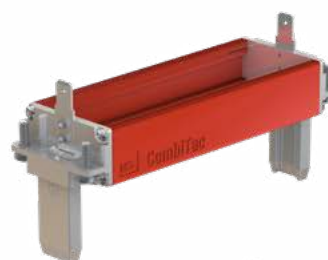

Please combine!

The simplest way to assemble a CombiTac can be found on our website:
www.staubli.com/electrical

CombiTac Configurator

Recommendation: It is simplest to use the configurator, together with this catalog and assembly instructions MA213... (also to be found on the website).

Our CombiTac configurator is now available for iPad in the App Store.



CombiTac Configurator

- For orders and offers
- Indication of the selected combination
- Choice of contact carriers
- Choice of contacts
- Preview and parts list

The screenshot shows the CombiTac Configurator interface. On the left, there are two views: 'Front view' showing a connector with a red selection box, and 'Side view' showing a cross-section of the connector with a red contact carrier. Below these views is a 'Carrier' selection table with columns for Pin, Order No., Type, Designation, and V. The table lists five carrier options. To the right of the table are buttons for 'Add', 'Remove', 'Left', and 'Right'. Below the table is a 'Contact' selection section with a dropdown menu and 'Change' and 'Change all' buttons. On the far right, there is a 'CombiTac Configurator' sidebar with the STÄUBLI logo, 'Housing' selection options, 'View' options for 'Male part' and 'Female part', 'Information' section with 'Configurable (MC)' and 'Preconfigured' checkboxes, and a 'Further' section with 'DE', 'EN', and 'FR' language options, a 'Help ?' link, and 'Preview' and 'Reset' buttons.

| Pin | Order No. | Type | Designation | ←→ (mm) | V |
|-----|-----------|-------------|----------------------|---------|---------|
| 1 | 33.4001 | CTE3-3 | Carrier | 10 | 400-500 |
| 2 | 33.4027 | CTE3-4/5 | Carrier Pin | 30 | |
| 3 | 33.4017 | CTE3-3P/0FS | Carrier PDF Pin Side | 6 | 0 |
| 4 | 33.4017 | CTE3-3P/0FS | Carrier PDF Pin Side | 6 | 0 |
| 5 | 33.4003 | CTE1-2/0S | Carrier Pin Side | 18 | 150-300 |

Ø 12 MM POWER UNIT UP TO 300 A

Contact carriers CT-E12-1/...

1-pole plastic contact carriers. Different designs for pins and sockets.

The contacts are locked by means of a retaining clip CT-RC12.

CT-E12-1/B

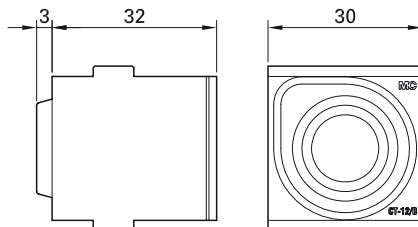

CT-E12-1/S

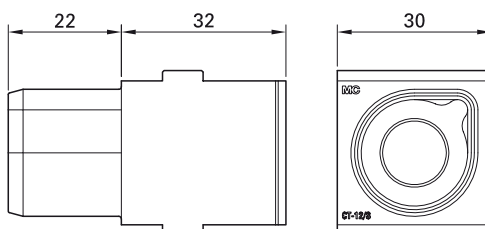

CT-RC12

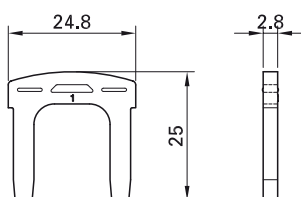

Assembly instructions MA213-01

www.staubli.com/electrical

| Order No. | Type | Description |
|-----------|------------|---|
| 33.4082 | CT-E12-1/B | Socket carrier (identification "B") |
| 33.4081 | CT-E12-1/S | Pin carrier (identification "S") |
| 33.4083 | CT-RC12 | Retaining clip (included with carriers) |

| Technical data | | |
|---|----------------------------|--|
| Number of poles | 1 | |
| For contact diameter | 12 mm | |
| Pollution degree/overvoltage category | 2/CATII | 3/CATIII |
| Rated voltage, crimp termination screw termination | 1000 V AC/DC IEC, 600 V UL | 800 V AC/DC IEC, 600 V UL 400 V AC/DC IEC, 600 V UL |
| Degree of protection (socket and plug front) | IP2X | |
| Clearances and creepage distance | IEC 60664-1 | |
| Limiting temperature (IEC 61984), upper lower | +90 °C -40 °C | |
| Contact carrier material | PA | |

Ø 12 mm contacts with crimp termination

For contact carriers CT-E12-1/... Sockets fitted with MULTILAM.

Type of termination:
Crimp termination (C) for Cu conductors (class 5 and 6)

CT-BP12/...



CT-SP12/...

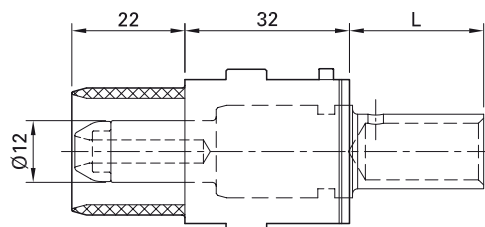

| Order No. | Type | Socket | Pin | Surface | Conductor cross section | | Rated current ¹⁾ A | Type of termination |
|----------------------------------|-------------------------------------|--------|-----|---------|-------------------------|-----|----------------------------------|---------------------|
| | | | | | mm ² | AWG | | |
| 33.0127 33.0558 | CT-BP12/50 AG CT-SP12/50 IP2X AG | x | x | | 50 | 1/0 | 200 | C |
| 33.0128 33.0559 | CT-BP12/70 AG CT-SP12/70 IP2X AG | x | x | | 70 | 2/0 | 245 | C |
| 33.0138 33.0562 | CT-BP12/95 AG CT-SP12/95 IP2X AG | x | x | | 95 | 3/0 | 300 | C |

Technical data

| | |
|--------------------------------|---------|
| Nominal-Ø socket/pin | 12 mm |
| Max. sliding force per contact | 28 N |
| Contact resistance | < 25 µΩ |
| Mating cycles | 100,000 |

¹⁾ Rated values refer to heat-resistant copper wires in accordance with DIN VDE 0298-4.



Assembly instructions MA213-01

www.staubli.com/electrical

Ø 12 mm contacts with M10 inside thread

For contact carriers CT-E12-1/... Sockets fitted with MULTILAM

Type of termination:
Screw termination (S) using an M10 inside thread by means of a cable lug for Cu conductors (class 5 and 6)

Note:
Screw terminations can not be fitted in housings due to space limitations.

CT-B12/M10 AG



CT-S12/M10 IP2X AG

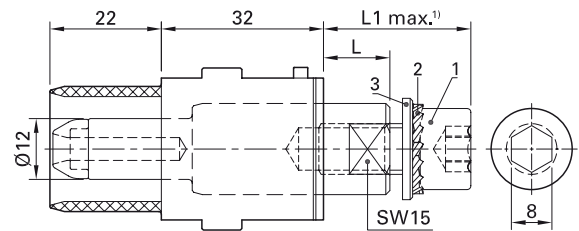

| Order No. | Type | Socket | Pin | Surface | Conductor cross section | | Rated current ²⁾ | Type of termination |
|-----------|-----------------------------|-----------|-----|---------|-------------------------|-----|-----------------------------|---------------------|
| | | | | | mm ² | AWG | | |
| 33.0139 | CT-B12/M10 AG | x | | | 50 | 1/0 | 200 | S |
| | | | | | 70 | 2/0 | 245 | |
| | | | | | 95 | 3/0 | 300 | |
| 33.0564 | CT-S12/M10 IP2X AG | | x | | 50 | 1/0 | 200 | S |
| | | | | | 70 | 2/0 | 245 | |
| | | | | | 95 | 3/0 | 300 | |
| 33001501 | K-SCH50-10 ³⁾ | Cable lug | | | 50 | 1/0 | | |
| 33.4114 | CT-K-SCH70-10 ³⁾ | Cable lug | | | 70 | 2/0 | | |
| 33.4115 | CT-K-SCH95-10 ³⁾ | Cable lug | | | 95 | 3/0 | | |

Individual parts (supplied with 33.0139 and 33.0564)

| Pos. | Order No. | Type | Remarks |
|------|-----------|-------------------------------------|----------------------------|
| 1 | 11004669 | ZYL-SHR-IN-6KT M10x20 ISO4762 BN610 | Cheese head screw M10x20 |
| 2 | 08.0706 | F/M10 DIN6798A BN781 | Serrated lock washer F/M10 |
| 3 | 08.0306 | U/M10 AG | Washer M10 |

| Technical data | |
|--------------------------------|---------|
| Nominal-Ø socket/pin | 12 mm |
| Max. sliding force per contact | 28 N |
| Contact resistance | 25 µΩ |
| Mating cycles | 100,000 |

¹⁾ Depending on cable lug size.
²⁾ Rated values refer to heat-resistant copper wires in accordance with DIN VDE 0298-4.
³⁾ Cable lugs Cu/Sn according to DIN 46234.

Selection of special DIN housings for CombiTac Ø 12 mm power unit

Step 1: Select the number of Ø 12 mm poles of your CombiTac connector (e.g. 2 x Ø 12 mm poles)

Step 2: Select the outer insulation diameter of your cable (e.g. 17 mm)

Step 3: Select the appropriate cable gland (e.g. order No. 33.4126 or 33.4122)

Step 4: Select a suitable DIN housing (e.g. size 3, order No. 33.1267)

| 1 Number of poles | 2 For Ø cable mm | 3 Cable gland | | | | 4 Suitable housing | | | |
|------------------------------------|------------------------|------------------|----------------|--------------------------|---------------------------|-----------------------|----------------|------------------------------|-----------------------------|
| | | Size M | Order No. | Type | Wrench size max. mm | Size | Order No. | Type | Position of cable glands |
| | | | | | | | | | |
| 1 | 14 – 17 | 32 | 33.4123 | CT-K-VSH M32x14-17 MS | 36 | 1 | 33.1571 | CT-TG1-G | |
| | 17 – 21 | | 33.4124 | CT-K-VSH M32x17-21 MS | | | | | |
| | 21 – 25 | | 33.4125 | CT-K-VSH M32x21-25,5 MS | | | | | |
| 2 (+/-) (L1/N) | 9.5 – 12.5 | 25 | 33.4120 | CT-K-VSH M25x9,5-12,5 MS | 30 | 3 | 33.1267 | CT-TG3-G/2xM25 | |
| | 10 – 17 | | 33.4126 | CT-K-VSH M25x10-17 MS | 28 | | | | |
| | 16 – 20.5 | | 33.4122 | CT-K-VSH M25x16-20,5 MS | 30 | | | | |
| | 17 – 21 | 32 | 33.4124 | CT-K-VSH M32x17-21 MS | 36 | 4 | 33.1269 | CT-TG4-G/2xM32 | |
| | 21 – 25 | | 33.4125 | CT-K-VSH M32x21-25,5 MS | | | | | |
| 3 (+/-/PE) (L1/N/PE) | 10 – 17 | 25 | 33.4126 | CT-K-VSH M25x10-17 MS | 28 | 4 | 33.1268 | CT-TG4-G/3xM25 | |
| | 9.5 – 12.5 | 25 | 33.4120 | CT-K-VSH M25x9,5-12,5 MS | 30 | | | | |
| | 10 – 17 | | 33.4126 | CT-K-VSH M25x10-17 MS | 28 | 5 | 33.1270 | 1) CT-TG5-G/4xM25 | |
| | 16 – 20.5 | | 33.4122 | CT-K-VSH M25x16-20,5 MS | 30 | | | | |
| | 17 – 21 | 32 | 33.4124 | CT-K-VSH M32x17-21 MS | 36 | 6 | 33.1272 | CT-TG6-G/3xM32 | |
| | 21 – 25 | | 33.4125 | CT-K-VSH M32x21-25,5 MS | | | | | |
| 4 (L1/L2/L3/PE) (L1/L2/L3/N) | 9.5 – 12.5 | 25 | 33.4120 | CT-K-VSH M25x9,5-12,5 MS | 30 | 5 | 33.1270 | CT-TG5-G/4xM25 | |
| | 10 – 17 | | 33.4126 | CT-K-VSH M25x10-17 MS | 28 | | | | |
| | 16 – 20.5 | | 33.4122 | CT-K-VSH M25x16-20,5 MS | 30 | | | | |
| | 17 – 21 | 32 | 33.4124 | CT-K-VSH M32x17-21 MS | 36 | 6+ | 33.1386 | CT-TG6+ ²⁾ | |
| | 21 – 25 | | 33.4125 | CT-K-VSH M32x21-25,5 MS | | | | | |
| 5 (L1/L2/L3/ N/PE) | 10 – 17 | 25 | 33.4126 | CT-K-VSH M25x10-17 MS | 28 | 6 | 33.1271 | CT-TG6-G/6xM25 ¹⁾ | |
| | 17 – 21 | 32 | 33.4124 | CT-K-VSH M32x17-21 MS | 36 | 6+ | 33.1386 | CT-TG6+ ²⁾ | |
| | 21 – 25 | | 33.4125 | CT-K-VSH M32x21-25,5 MS | | | | | |

¹⁾ Close one gland opening with cap (not provided).

²⁾ Special housings available on request.

Contact carrier CT-E8/6-PE

1-pole contact carrier made of resilient plastic. **Marked with a protective earth (PE) symbol.**

CT-E8/6-PE 

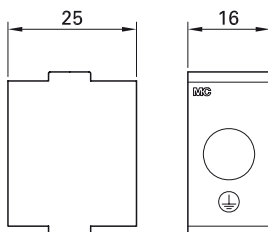

| Order No. | Type |
|-----------|------------|
| 33.4008 | CT-E8/6-PE |

| Technical data | | |
|---|---|--|
| Number of poles | 1 | |
| For contact diameter | 8 mm | |
| Pollution degree / overvoltage category | 2/CATII | 3/CATIII |
| Rated voltage, crimp termination screw termination | 1000 V AC/DC IEC, 600 V UL 600 V AC/DC IEC, 600 V UL | 400 V AC/DC IEC, 600 V UL 300 V AC/DC IEC, 600 V UL |
| Degree of protection (socket and plug front) | IP00 | |
| Clearances and creepage distance | IEC 60664-1 | |
| Limiting temperature (IEC 61984), upper lower | +90 °C -40 °C | |
| Contact carrier material | EPTR | |



Assembly instructions MA213-01

www.staubli.com/electrical

Ø 8 mm first mate contacts with crimp termination

For contact carrier CT-E8/6-PE. Sockets fitted with MULTILAM. For protective earth (PE) purposes only.

Type of termination:
Crimp termination (C) for Cu conductors (class 5 and 6)

CT-BP8/...PE-L AG



CT-SP8/...PE-L AG

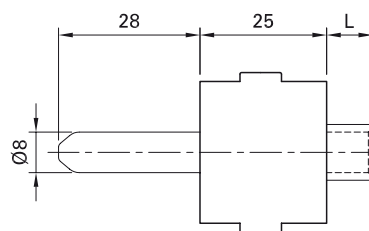

| Order No. | Type | Socket | Pin | Surface | Conductor cross section | | Short circuit current 3s kA | Type of termination |
|-----------|-------------------|--------|-----|---------|-------------------------|-----|-----------------------------------|---------------------|
| | | | | | mm ² | AWG | | |
| 33.0205 | CT-BP8/25/PE-L AG | × | | | 25 | 4 | 1.3 | C |
| 33.0705 | CT-SP8/25/PE-L AG | | × | | 25 | 4 | 1.3 | C |
| 33.0206 | CT-BP8/35/PE-L AG | × | | | 35 | 2 | 1.6 | C |
| 33.0706 | CT-SP8/35/PE-L AG | | × | | 35 | 2 | 1.6 | C |
| 33.0207 | CT-BP8/50/PE-L AG | × | | | 50 | 1/0 | 1.6 | C |
| 33.0707 | CT-SP8/50/PE-L AG | | × | | 50 | 1/0 | 1.6 | C |

Technical data

| | |
|--------------------------------|---------|
| Nominal-Ø socket/pin | 8 mm |
| Max. sliding force per contact | 11.5 N |
| Mating cycles | 100,000 |



Assembly instructions MA213-01

www.staubli.com/electrical

Ø 8 mm first mate contacts with M8 outside thread

For contact carrier CT-E8/6-PE, first mate. Sockets fitted with MULTILAM. For protective earth (PE) purposes only.

Type of termination:
Screw termination (S) with an M8 male thread by means of a cable lug for Cu conductors (class 5 and 6)

Note:
Screw terminations can not be fitted in housings due to space limitations.

CT-B8/M8A/PE-L AG



CT-S8/M8A/PE-L AG

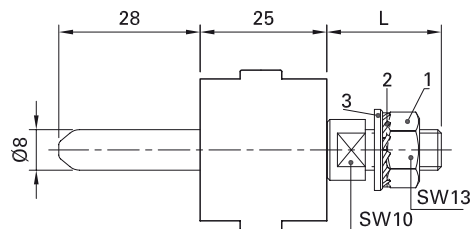

| Order No. | Type | Socket | Pin | Surface | Conductor cross section | | Short circuit current | Type of termination |
|-----------|----------------------------|-----------|-----|---------|-------------------------|-----|-----------------------|---------------------|
| | | | | | mm ² | AWG | | |
| 33.0208 | CT-B8/M8A/PE-L AG | x | | | 25 | 4 | 1.3 | S |
| 33.0708 | CT-S8/M8A/PE-L AG | | x | | 35 | 2 | 1.6 | |
| | | | | | 50 | 1/0 | 1.6 | |
| 33.4117 | CT-K-SCH25-8 ¹⁾ | Cable lug | | | 25 | 4 | 1.3 | |
| 33.4116 | CT-K-SCH35-8 ¹⁾ | Cable lug | | | 35 | 2 | 1.6 | |
| 31002862 | K-SCH50-8 ¹⁾ | Cable lug | | | 50 | 1/0 | 1.6 | |
| 33.4085 | CT-DIP4/2 ²⁾ | Spacer | | | | | | |

Individual parts (supplied with 33.0208 and 33.0708)

| Pos. | Order No. | Type | Remarks |
|------|-----------|---------------------|---------------------------|
| 1 | 08.0105 | MU0,8D/M8 AG | 6 kt. Hex. nut M8 |
| 2 | 08.0705 | F/M8 DIN6798A BN781 | Serrated lock washer F/M8 |
| 3 | 08.0305 | U/M8 AG | Washer M8 |

| Technical data | |
|--------------------------------|---------|
| Nominal-Ø socket/pin | 8 mm |
| Max. sliding force per contact | 11.5 N |
| Mating cycles | 100,000 |

¹⁾ Cable lugs Cu/Sn according to DIN 46234 (class 5).
²⁾ Ground contacts with an M8 external thread must be separated from the Ø 12 mm contact by means of a CT-DIP4/2 spacer.



CombiTac: modular, compact, versatile

Ø 8 MM POWER UNIT UP TO 150 A

Contact carrier CT-E8-...

2-pole contact carriers made from resilient plastic.

To prevent flashover, there is a dividing wall between the two poles in the termination area.

CT-E8-2-IP2X

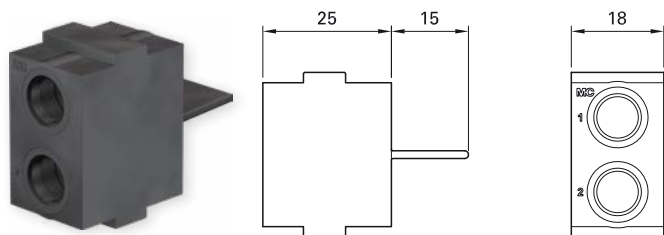

CT-E8-2

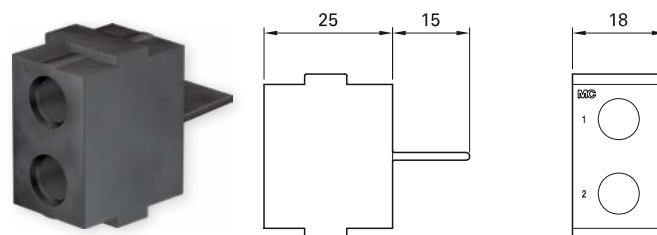

| Order No. | Type | Description |
|-----------|--------------|-------------------------------------|
| 33.4139 | CT-E8-2-IP2X | Socket carrier (identification "B") |
| 33.4000 | CT-E8-2 | Pin carrier |

| Technical data | | |
|---|--------------|-------------|
| Number of poles | 2 | |
| For contact diameter | 8 mm | |
| Pollution degree / overvoltage category | 2 / CATII | 3 / CATIII |
| Rated voltage, crimp termination | 1000 V AC/DC | 300 V AC/DC |
| screw termination | 600 V AC/DC | 300 V AC/DC |
| Degree of protection (socket front) | IP2X | |
| Clearances and creepage distance | IEC 60664-1 | |
| Limiting temperature (IEC 61984), upper | +90 °C | |
| lower | -40 °C | |
| Contact carrier material | EPTR | |

Footnotes and technical data from pages 17:

| Technical data | |
|--------------------------------|--|
| Nominal-Ø socket/pin | 8 mm |
| Max. sliding force per contact | 11.5 N |
| Contact resistance | < 150 µΩ |
| Mating cycles | 100,000 |
| Vibrations | 4.2 g/5 – 250 Hz (DIN EN 61373) 10 g/10 – 500 Hz (DIN EN 60068-2-6) |
| Resistance to shocks | 30 g/18 ms (DIN EN 61373) |

* Pin size same for all types of terminations.

¹⁾ Rated current for fully occupied carriers. Derating diagrams for bundled cables see pages 104 – 108.

²⁾ Only 1 contact per contact carrier permitted.

³⁾ Cable lugs for smaller conductor cross sections (acc. to DIN 46234) are available commercially.

⁴⁾ Arrangement of blind plugs with one contact per carrier. For contacts with crimp termination only.



Assembly instructions MA213-01

www.staubli.com/electrical

Ø 8 mm contacts

For contact carrier CT-E8-2-IP2X and CT-E8-2. Sockets fitted with MULTILAM.

Type of termination:

- Crimp termination (C) for Cu conductors (class 5 and 6)
- Screw termination (S) for cable lugs and contacts with M6 inside or outside thread

Note:

Screw terminations can not be fitted in housings due to space limitations.

CT-BP8/...



CT-SP8/...



CT-E8-2-IP2X

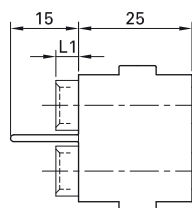

CT-E8-2

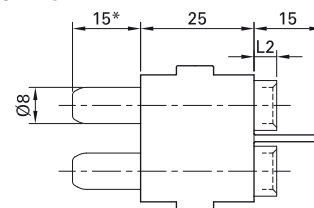

| Order No. | Type | Socket | Pin | Surface | Conductor cross section | | Rated current ¹⁾ | Type of termination |
|--------------------|------------------------------|--------------------------|-----|---------|-------------------------|-----|--------------------------------------|---------------------|
| | | | | | mm ² | AWG | | |
| 33.0100 33.0500 | CT-BP8/10 AG CT-SP8/10 AG | x | x | | 10 | 8 | 55 | C |
| 33.0101 33.0501 | CT-BP8/10 AU CT-SP8/10 AU | x | x | | | | | |
| 33.0102 33.0502 | CT-BP8/16 AG CT-SP8/16 AG | x | x | | 16 | 6 | 75 | C |
| 33.0103 33.0503 | CT-BP8/16 AU CT-SP8/16 AU | x | x | | | | | |
| 33.0104 33.0504 | CT-BP8/25 AG CT-SP8/25 AG | x | x | | 25 | 4 | 100 | C |
| 33.0105 33.0505 | CT-BP8/25 AU CT-SP8/25 AU | x | x | | | | | |
| 33.0106 33.0506 | CT-BP8/35 AG CT-SP8/35 AG | x | x | | 35 | 2 | 120 ¹⁾ /150 ²⁾ | C |
| 33.0110 33.0510 | CT-B8/M6 AG CT-S8/M6 AG | x | x | | | | | |
| 33.0111 33.0511 | CT-B8/M6 AU CT-S8/M6 AU | x | x | | 25 | 4 | 100 | S |
| 33.0120 33.0520 | CT-B8/M6A AG CT-S8/M6A AG | x | x | | | | | |
| 33.0121 33.0521 | CT-B8/M6A AU CT-S8/M6A AU | x | x | | 35 | 2 | 120 | S |
| 33.4039 | CT-KSCH6-35 ³⁾ | Cable lug | | | | | | |
| 33.4050 | CT-BS8 | Blind plug ⁴⁾ | | | | | | |

Ø 6 MM AND Ø 8 MM POWER UNIT UP TO 125 A, 150 A

Contact carriers CT-E8/6-...

1-pole contact carrier made of resilient plastic. **Marked with either a protective earth (PE) symbol or a "1"**.

CT-E8/6-PE 

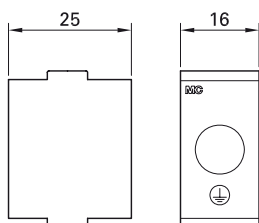

CT-E8/6-1

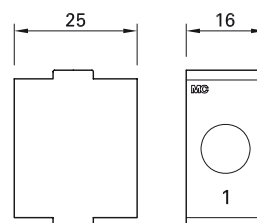

| Order No. | Type | Description |
|-----------|------------|--|
| 33.4008 | CT-E8/6-PE | Contact carrier with  |
| 33.4013 | CT-E8/6-1 | Contact carrier with number "1" |

| Technical data | | |
|--|--------------|-------------|
| Number of poles | 1 | |
| For contact diameter | 8 mm/6 mm | |
| Pollution degree / overvoltage category | 2/CATII | 3/CATIII |
| Rated voltage, crimp termination | 1000 V AC/DC | 400 V AC/DC |
| screw termination | 600 V AC/DC | 300 V AC/DC |
| Degree of protection (socket and plug front) | IP00 | |
| Clearances and creepage distance | IEC 60664-1 | |
| Limiting temperature (IEC 61984), upper | +90 °C | |
| lower | -40 °C | |
| Contact carrier material | EPTR | |



Assembly instructions MA213-01

www.staubli.com/electrical

First mate contacts Ø 6 mm and Ø 8 mm

For contact carriers CT-E8/6-PE, first mate. Sockets fitted with MULTILAM. For protective earth (PE) purposes only.

Type of termination:

- Crimp termination (C) for Cu conductors (class 5 and 6)
- Screw termination (S) for cable lugs

Note:

Screw terminations can not be fitted in housings due to space limitations.

CT-B...PE AG 



CT-S...PE AG 

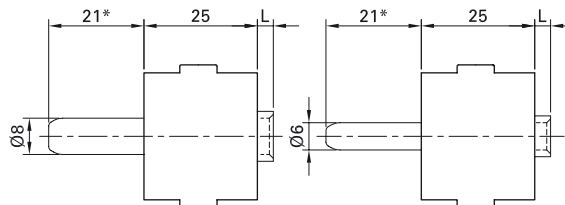

| Order No. | Type | Socket | Pin | Surface | Conductor cross section | | Short circuit current | Type of termination |
|----------------|---------------------------|-----------|-----|---|-------------------------|-----|-----------------------|---|
| | | | | | mm ² | AWG | | |
| 33.0113 | CT-BP6/16/PE AG | x | |  | 16 | 6 | 860 | C  |
| 33.0513 | CT-SP6/16/PE AG | | x |  | 16 | 6 | 860 | C  |
| 33.0123 | CT-B6/M5A/PE AG | x | |  | 6 | 10 | 320 | S  |
| 33.0523 | CT-S6/M5A/PE AG | | x |  | 10 | 8 | 540 | |
| | | | |  | 16 | 6 | 860 | |
| | | | |  | 25 | 4 | 1600 | |
| 33.0114 | CT-BP8/25/PE AG | x | |  | 25 | 4 | 1300 | C  |
| 33.0514 | CT-SP8/25/PE AG | | x |  | 25 | 4 | 1300 | C  |
| 33.0119 | CT-B8/M6A/PE AG | x | |  | 10 | 8 | 540 | S  |
| 33.0519 | CT-S8/M6A/PE AG | | x |  | 16 | 6 | 860 | |
| | | | |  | 25 | 4 | 1300 | |
| | | | |  | 35 | 2 | 1600 | |
| 33.4039 | CT-KSCH6-35 ¹⁾ | Cable lug | | | 35 | 2 | fits with CT...8... |  |

Technical data

| | |
|--------------------------------|--|
| Nominal-Ø socket/pin | 6 mm/8 mm |
| Max. sliding force per contact | 11.5 N |
| Contact resistance | < 250 µΩ / < 150 µΩ |
| Mating cycles | 100,000 |
| Vibrations | 4.2 g/5 – 250 Hz (DIN EN 61373) 10 g/10 – 500 Hz (DIN EN 60068-2-6) |
| Resistance to shocks | 30 g/18 ms (DIN EN 61373) |

* Pin size same for all types of terminations.

¹⁾ Cable lugs for smaller conductor cross sections (according to DIN 46234) are available commercially.

Ø 6 MM POWER UNIT UP TO 120 A

Contact carrier CT-E6-2

2-pole contact carrier made of resilient plastic. To prevent flashover, there is a dividing wall between the two poles in the termination area.

CT-E6-2

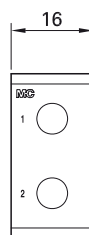
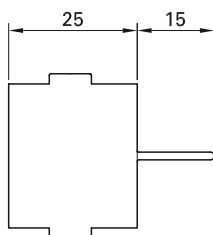

| Order No. | Type |
|-----------|---------|
| 33.4006 | CT-E6-2 |

| Technical data | | |
|---|-----------------------------|----------------------------|
| Number of poles | 2 | |
| For contact diameter | 6 mm | |
| Pollution degree / overvoltage category | 2/CATII | 3/CATIII |
| Rated voltage, crimp termination screw termination | 1000 V AC/DC 600 V AC/DC | 500 V AC/DC 300 V AC/DC |
| Degree of protection (socket front) | IP2X | |
| Clearances and creepage distance | IEC 60664-1 | |
| Limiting temperature (IEC 61984), upper lower | +90 °C -40 °C | |
| Contact carrier material | EPTR | |



Assembly instructions MA213-01

www.staubli.com/electrical

∅ 6 mm contacts

For contact carriers CT-E6-2. Sockets fitted with MULTILAM.

Type of termination:

- Crimp termination (C) for Cu conductors (class 5 and 6)
- Screw termination (S) for cable lugs and contacts with an M5 inside or outside thread

Note:

Screw terminations can not be fitted in housings due to space limitations.

CT-B6...



CT-S6...

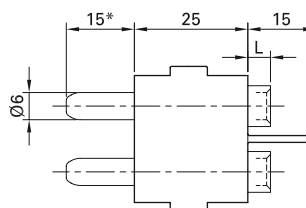

| Order No. | Type | Socket | Pin | Surface | Conductor cross section | | Rated current ¹⁾ | Type of termination |
|--------------------|------------------------------|------------|-----|---------|-------------------------|-------------------|-----------------------------|---------------------|
| | | | | | mm ² | AWG | | |
| 33.0107 33.0507 | CT-BP6/6 AG CT-SP6/6 AG | x | x | | 6 | 10 | 40 | C |
| 33.0108 33.0508 | CT-BP6/10 AG CT-SP6/10 AG | x | x | | 10 | 8 | 55 | C |
| 33.0109 33.0509 | CT-BP6/16 AG CT-SP6/16 AG | x | x | | 16 | 6 | 75 | C |
| 33.0112 33.0512 | CT-B6/M5 AG CT-S6/M5 AG | x | x | | 6 10 16 25 | 10 8 6 4 | 40 55 75 100 | S ²⁾ |
| 33.0122 33.0522 | CT-B6/M5A AG CT-S6/M5A AG | x | x | | 6 10 16 25 | 10 8 6 4 | 40 55 75 100 | S ²⁾ |
| 18.5502 | MVS5 | Blind plug | | | | | | |

| Technical data | |
|--------------------------------|--|
| Nominal-∅ socket/pin | 6 mm |
| Max. sliding force per contact | 11.5 N |
| Contact resistance | < 250 µΩ |
| Mating cycles | 100,000 |
| Vibrations | 4.2 g/5 – 250 Hz (DIN EN 61373) 10 g/10 – 500 Hz (DIN EN 60068-2-6) |
| Resistance to shocks | 30 g/18 ms (DIN EN 61373) |

* Pin size same for all types of terminations.

¹⁾ Rated current for fully occupied carriers. Derating diagrams for bundled leads, see pages 104 – 108.

²⁾ Cable lugs according to DIN 46234 are available commercially.



Assembly instructions MA213-01

www.staubli.com/electrical

Ø 3 MM POWER UNIT UP TO 40 A

Contact carriers CT-E3-3, CT-E3-3/PCB

3-pole contact carriers made of resilient plastic. Different contact carriers for crimping (C) or flow-soldering (PCB) termination.

CT-E3-3

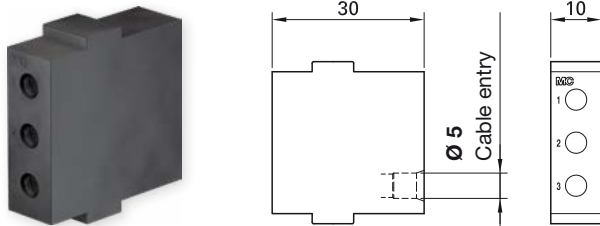

CT-E3-3/PCB

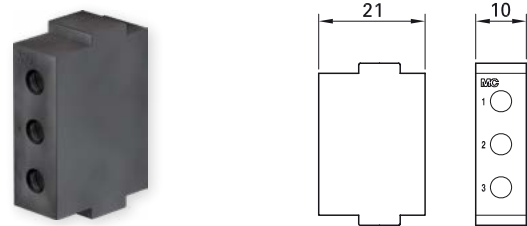

| Order No. | Type | Description |
|-----------|-------------|------------------------------------|
| 33.4001 | CT-E3-3 | Contact carrier for crimping |
| 33.4004 | CT-E3-3/PCB | Contact carrier for flow-soldering |

| Technical data | | |
|---|--------------|-------------|
| Number of poles | 3 | |
| For contact diameter | 3 mm | |
| Pollution degree / overvoltage category | 2/CATII | 3/CATIII |
| Rated voltage | 1000 V AC/DC | 400 V AC/DC |
| Max. flow-soldering temperature | 260 °C | |
| Max. flow-soldering time | 3 s | |
| Degree of protection (socket front) | IP2X | |
| Clearances and creepage distance | IEC 60664-1 | |
| Limiting temperature (IEC 61984), upper | +90 °C | |
| lower | -40 °C | |
| Contact carrier material | EPTR | |



Assembly instructions MA213-01

www.staubli.com/electrical

∅ 3 mm contacts

For contact carriers CT-E3-3... Sockets fitted with MULTILAM.

Type of termination:

- Crimp termination (C) for Cu conductors (class 5 and 6)
- Flow-soldering (PCB)

CT-BP3...



CT-SP3...

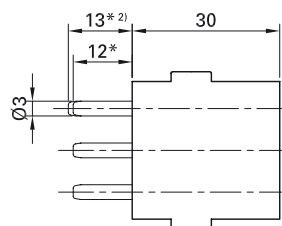

| Order No. | Type | Socket | Pin | Surface | Conductor cross section | | Rated current ¹⁾ | Type of termination |
|--------------------|--|------------|--------|---------|-------------------------|----------|-----------------------------|---------------------|
| | | | | | mm ² | AWG | | |
| 33.0131 | CT-BP3/2,5-4 AU | x | | | 2.5 4 | 14 12 | 22 35 | C |
| 33.0533 33.0531 | CT-SP3/2,5-4L AU ²⁾ CT-SP3/2,5-4K AU | | x x | | 2.5 – 4 | 14/12 | 22 – 35 | |
| 33.0135 | CT-B3/PCB AU | x | | | – | | 35 | PCB ³⁾ |
| 33.0537 33.0535 | CT-S3/PCB-L AU ²⁾ CT-S3/PCB-K AU | | x x | | – – | | 35 35 | |
| 18.5501 | MVS3 | Blind plug | | | | | | |

| Technical data | |
|--------------------------------|--|
| Nominal-∅ socket/pin | 3 mm |
| Max. sliding force per contact | 4 N |
| Contact resistance | < 1.1 mΩ |
| Mating cycles | 100,000 |
| Vibrations | 4.2 g/5 – 250 Hz (DIN EN 61373) 10 g/10 – 500 Hz (DIN EN 60068-2-6) |
| Resistance to shocks | 30 g/18 ms (DIN EN 61373) |

* Pin sizes same for all type of terminations.

¹⁾ Rated current for fully occupied carriers. Derating diagrams for bundled leads, see pages 104 – 108.

²⁾ Longer type of pin mates first.

³⁾ For drilling plans, see assembly instructions MA213-01.



Assembly instructions MA213-01

www.staubli.com/electrical

Contact carrier CT-E3-2+PE

3-pole contact carrier made of resilient plastic.

One pole functions as a protective earth (PE) contact and is **marked with a protective earth (PE) symbol**.

CT-E3-2+PE 

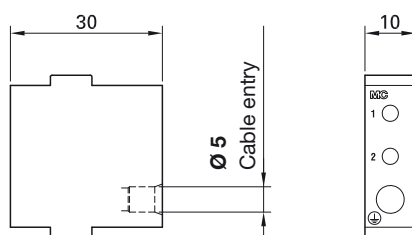

| Order No. | Type |
|-----------|------------|
| 33.4007 | CT-E3-2+PE |

| Technical data | | |
|---|--------------------|-------------|
| Number of poles | 2 + 1 PE | |
| For contact diameter | 3 mm | |
| Pollution degree / overvoltage category | 2/CATII | 3/CATIII |
| Rated voltage | 1000 V AC/DC | 400 V AC/DC |
| Degree of protection (socket front) | IP2X ¹⁾ | |
| Clearances and creepage distance | IEC 60664-1 | |
| Limiting temperature (IEC 61984), upper | +90 °C | |
| lower | -40 °C | |
| Contact carrier material | EPTR | |

¹⁾ Except for PE contact.



Assembly instructions MA213-01

www.staubli.com/electrical

∅ 3 mm contacts

For contact carriers CT-E3-2+PE. Sockets fitted with MULTILAM. Protective earth (PE) contacts and standard contacts. PE contacts for protective earth (PE) purposes only.¹⁾

Type of termination:

- Crimp termination (C) for Cu conductors (class 5 and 6)

CT-BP3/2,5-4/PE AU ⊕



CT-SP3/2,5-4/PE AU ⊕

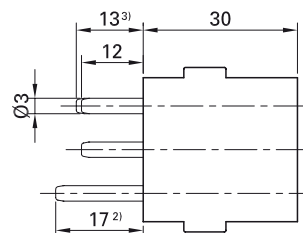

| Order No. | Type | Socket | Pin | Surface | Conductor cross section | | Rated current ²⁾ | Type of termination | |
|-----------|----------------------------------|------------|-----|---------|-------------------------|----------|------------------------------------|---------------------|--|
| | | | | | mm ² | AWG | | | |
| 33.0129 | CT-BP3/2,5-4/PE AU ³⁾ | x | | | 2.5 4 | 14 12 | – ¹⁾ – ¹⁾ | | |
| 33.0529 | CT-SP3/2,5-4/PE AU ³⁾ | | x | | 2.5 4 | 14 12 | – ¹⁾ – ¹⁾ | | |
| 33.0131 | CT-BP3/2,5-4 AU | x | | | 2.5 4 | 14 12 | 22 35 | | |
| 33.0533 | CT-SP3/2,5-4L AU ⁴⁾ | | x | | 2.5 | 14 | 22 | | |
| 33.0531 | CT-SP3/2,5-4K AU | | x | | 4 | 12 | 35 | | |
| 18.5501 | MVS3 | Blind plug | | | | | | | |

| Technical data | |
|--------------------------------|--|
| Nominal-∅ socket/pin | 3 mm |
| Max. sliding force per contact | 4 N |
| Contact resistance | < 1.1 mΩ |
| Mating cycles | 100,000 |
| Vibrations | 4.2 g/5 – 250 Hz (DIN EN 61373) 10 g/10 – 500 Hz (DIN EN 60068-2-6) |
| Resistance to shocks | 30 g/18 ms (DIN EN 61373) |

¹⁾ Short circuit current 3s
2.5 mm²: 135 A
4 mm²: 216 A

²⁾ Rated current for fully occupied carriers. Derating diagrams for bundled leads, see pages 104 – 108.

³⁾ Protective earth (PE) contact.

⁴⁾ Longer type of pin mates first.



Assembly instructions MA213-01

www.staubli.com/electrical

Ø 3 MM HIGH VOLTAGE UNIT UP TO 5 KV

Contact carriers CT-E3-.../HV...

1- and 2-pole contact carriers made of resilient plastic. With PTFE insert.

Note:
The maximum outside diameter of the conductor insulation is 6.6 mm.

CT-E3-1/HV-B



CT-E3-2/HV-B

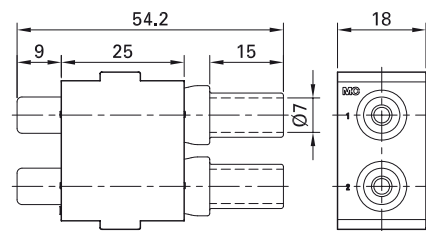

CT-E3-1/HV-S



CT-E3-2/HV-S

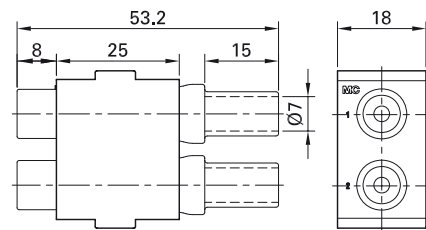

| Order No. | Type | Description |
|-----------|--------------|-----------------------|
| 33.4136 | CT-E3-2/HV-B | 2-pole socket carrier |
| 33.4137 | CT-E3-1/HV-B | 1-pole socket carrier |
| 33.4536 | CT-E3-2/HV-S | 2-pole pin carrier |
| 33.4537 | CT-E3-1/HV-S | 1-pole pin carrier |

| Technical data | |
|---|--------|
| Number of poles | 1 or 2 |
| For contact diameter | 3 mm |
| Pollution degree | 2 |
| Rated voltage phase-to-earth | 2.9 kV |
| Rated voltage phase-to-phase | 5 kV |
| Degree of protection (in mated condition) | IP2X |
| Limiting temperature (IEC 61984), upper | +90 °C |
| lower | -40 °C |
| Contact carrier material | EPTR |
| Insulation material | PTFE |



Assembly instructions MA213-05

www.staubli.com/electrical

Ø 3 mm/HV

For contact carrier CT-E.../HV-... Sockets fitted with MULTILAM.

Type of termination:

Crimp termination (C) for Cu high voltage conductors 2.5 mm², followed by insulation with shrink tubing CT-HV-SRTU

Note:

- All data regarding ratings apply to the mated condition
- Connector without breaking capacity (COC)
- The connector must not be connected or disconnected when live or under load

CT-BP3/2,5-HV AU



CT-SP3/2,5-HV AU

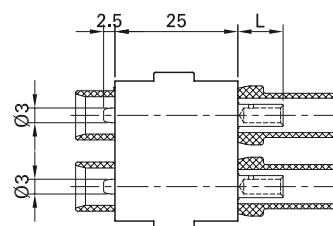

| Order No. | Type | Socket | Pin | Surface | Conductor cross section | | Rated current ¹⁾ | | Type of termination |
|-----------|------------------|--------|-----|---------|-------------------------|-----|-----------------------------|--------|---------------------|
| | | | | | mm ² | AWG | 2 poles | 1 pole | |
| 33.0163 | CT-BP3/2,5-HV AU | × | | | 2.5 | 14 | 20 A | 32 A | |
| 33.0563 | CT-SP3/2,5-HV AU | | × | | | | | | |

Accessories

| | | | | |
|---------|------------|--------------------------------|--|--|
| 33.5666 | CT-HV-SRTU | Shrink tubing 45 mm (included) | | |
|---------|------------|--------------------------------|--|--|

Recommended cable

| Order No. | Type | Conductor cross section | | Rated current ¹⁾ | | Colors |
|-----------|-------------|-------------------------|-----|-----------------------------|--------|--------|
| | | mm ² | AWG | 2 poles | 1 pole | |
| 61.7634-* | SILI-HV 2,5 | 2.5 | 14 | 20 A | 32 A | 21 22 |

Technical data

| | |
|--------------------------------|--|
| Nominal-Ø socket/pin | 3 mm |
| Max. sliding force per contact | 4 N |
| Contact resistance | < 1.1 mΩ |
| Mating cycles | 100,000 |
| Vibrations | 4.2 g/5 – 250 Hz (DIN EN 61373) 10 g/10 – 500 Hz (DIN EN 60068-2-6) |
| Resistance to shocks | 30 g/18 ms (DIN EN 61373) |



Assembly instructions MA213-05

www.staubli.com/electrical

* Add the desired color code.

¹⁾ Rated current for fully occupied carriers. Derating diagrams for bundled wires on request.

Ø 1.5 MM SIGNAL UNIT UP TO 19 A

Contact carrier CT-E1,5-5

5-pole contact carrier made of resilient plastic.

CT-E1,5-5

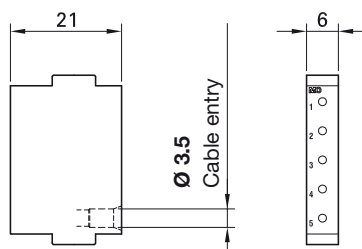

| Order No. | Type |
|-----------|-----------|
| 33.4005 | CT-E1,5-5 |

| Technical data | | |
|---|-------------|-------------|
| Number of poles | 5 | |
| For contact diameter | 1.5 mm | |
| Pollution degree / overvoltage category | 2/CATII | 3/CATIII |
| Rated voltage | 600 V AC/DC | 250 V AC/DC |
| Max. flow-soldering temperature | 260 °C | |
| Max. flow-soldering time | 3 s | |
| Degree of protection (socket front) | IP2X | |
| Clearances and creepage distance | IEC 60664-1 | |
| Limiting temperature (IEC 61984), upper | +90 °C | |
| lower | -40 °C | |
| Contact carrier material | EPTR | |



Assembly instructions MA213-01

www.staubli.com/electrical

Ø 1.5 mm contacts

For contact carriers CT-E1,5-5. Sockets fitted with MULTILAM.

Type of termination:

- Crimp termination (C) for Cu conductors (class 5) (CT...P1,5/1,5... also for class 6)
- Flow-soldering (PCB)

CT-BP1,5...



CT-SP1,5...

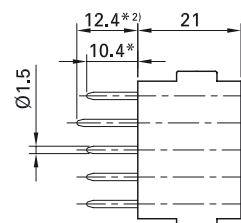

| Order No. | Type | Socket | Pin | Surface | Conductor cross section | | Rated current ¹⁾ | Type of termination |
|-----------|------------------------------------|------------|-----|---------|-------------------------|-----|-----------------------------|---------------------|
| | | | | | mm ² | AWG | | |
| 33.0153 | CT-BP1,5LAV/0,5-1,5 AU | x | | | 0.5 | 20 | 5 | C |
| | | | | | 0.75 | 18 | 8 | |
| | | | | | 1.0 | 18 | 10 | |
| | | | | | 1.5 | 16 | 10 | |
| 33.0551 | CT-SP1,5/0,5-1,5L AU ²⁾ | | x | | 0.5 | 20 | 5 | C |
| 33.0550 | CT-SP1,5/0,5-1,5K AU | | x | | 0.75 | 18 | 8 | |
| | | | | | 1.0 | 18 | 10 | |
| | | | | | 1.5 | 16 | 10 | |
| 33.0156 | CT-BP1,5LAV/1,5 AU ³⁾ | x | | | 1.5 | 16 | 10 | C |
| 33.0555 | CT-SP1,5/1,5K AU ³⁾ | | x | | 1.5 | 16 | 10 | C |
| 33.0157 | CT-B1,5LAV/PCB AU | x | | | 1.5 | 16 | 10 | PCB ⁴⁾ |
| 33.0553 | CT-S1,5/PCB-L AU ²⁾ | | x | | | | 10 | PCB ⁴⁾ |
| 33.0552 | CT-S1,5/PCB-K AU | | x | | | | 10 | |
| 18.5504 | MVS1 | Blind plug | | | | | | |

| Technical data | |
|--------------------------------|--|
| Nominal-Ø socket/pin | 1.5 mm |
| Max. sliding force per contact | 1.5 N |
| Contact resistance | < 1.1 mΩ |
| Mating cycles | 100,000 |
| Vibrations | 4.2 g/5 – 250 Hz (DIN EN 61373) 10 g/10 – 500 Hz (DIN EN 60068-2-6) |
| Resistance to shocks | 30 g/18 ms (DIN EN 61373) |



Assembly instructions MA213-01

www.staubli.com/electrical

* Pin size same for all types of terminations.

¹⁾ Rated current for fully occupied carriers. Derating diagrams for bundled leads, see pages 104 – 108.

²⁾ Longer type of pin mates first.

³⁾ For Cu conductors (class 6).

⁴⁾ For drilling plans, see assembly instructions MA213-01.

Ø 1 MM SIGNAL UNIT UP TO 12 A

Contact carriers CT-E1-26/...

26-pole contact carrier made of resilient plastic. Different designs for pins and sockets.

For suitable contacts, see page 33.

CT-E1-26/B

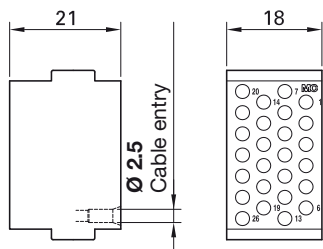

CT-E1-26/S

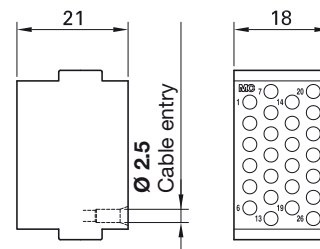

| Order No. | Type | Description |
|-----------|------------|-------------------------------------|
| 33.4002 | CT-E1-26/B | Socket carrier (identification "B") |
| 33.4003 | CT-E1-26/S | Pin carrier (identification "S") |

| Technical data | | |
|---|-------------|-------------|
| Number of poles | 26 | |
| For contact diameter | 1 mm | |
| Pollution degree / overvoltage category | 2/CATII | 3/CATIII |
| Rated voltage | 300 V AC/DC | 150 V AC/DC |
| Max. flow-soldering temperature | 260 °C | |
| Max. flow-soldering time | 3 s | |
| Degree of protection (socket front) | IP2X | |
| Clearances and creepage distance | IEC 60664-1 | |
| Limiting temperature (IEC 61984), upper | +90 °C | |
| lower | -40 °C | |
| Contact carrier material | EPTR | |



Assembly instructions MA213-01

www.staubli.com/electrical

Contact carriers CT-E1-15/...

15-pole contact carrier made of resilient plastic. Different designs for pins and sockets.

For suitable contacts, see page 33.

CT-E1-15/B

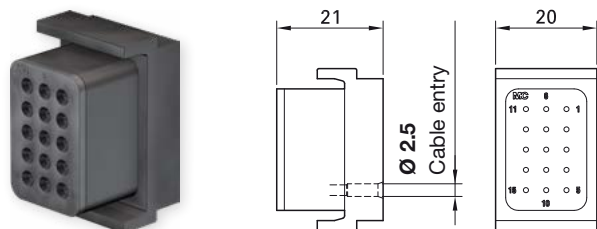

CT-E1-15/S

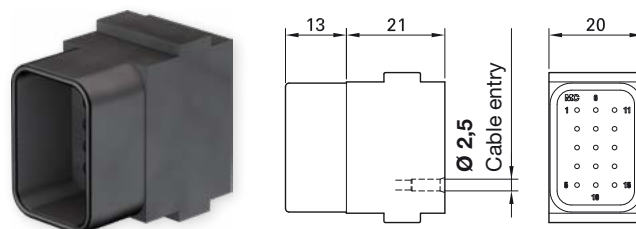

| Order No. | Type | Description |
|-----------|------------|-------------------------------------|
| 33.4022 | CT-E1-15/B | Socket carrier (identification "B") |
| 33.4023 | CT-E1-15/S | Pin carrier (identification "S") |

| Technical data | | |
|---|-------------|-------------|
| Number of poles | 15 | |
| For contact diameter | 1 mm | |
| Pollution degree / overvoltage category | 2/CATII | 3/CATIII |
| Rated voltage | 300 V AC/DC | 150 V AC/DC |
| Max. flow-soldering temperature | 260 °C | |
| Max. flow-soldering time | 3 s | |
| Degree of protection (socket front) | IP2X | |
| Clearances and creepage distance | IEC 60664-1 | |
| Limiting temperature (IEC 61984), upper | +90 °C | |
| lower | -40 °C | |
| Contact carrier material | PA & EPTR | |



Assembly instructions MA213-01

www.staubli.com/electrical

Contact carrier CT-E1-6

6-pole contact carrier made of resilient plastic. For suitable contacts, see page 33.

CT-E1-6

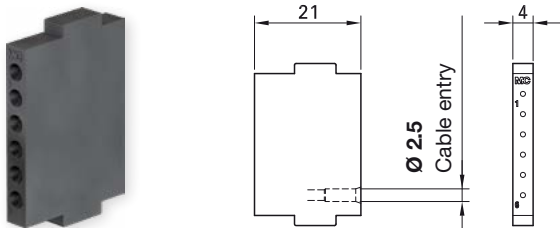

| Order No. | Type |
|-----------|---------|
| 33.4014 | CT-E1-6 |

| Technical data | | |
|---|-------------|-------------|
| Number of poles | 6 | |
| For contact diameter | 1 mm | |
| Pollution degree / overvoltage category | 2/CATII | 3/CATIII |
| Rated voltage | 300 V AC/DC | 150 V AC/DC |
| Max. flow-soldering temperature | 260 °C | |
| Max. flow-soldering time | 3 s | |
| Degree of protection (socket front) | IP2X | |
| Clearances and creepage distance | IEC 60664-1 | |
| Limiting temperature (IEC 61984), upper | +90 °C | |
| lower | -40 °C | |
| Contact carrier material | EPTR | |



Assembly instructions MA213-01

www.staubli.com/electrical

Ø 1 mm contacts

For contact carriers CT-E1-26/..., CT-E1-15/..., and CT-E1-6. Sockets fitted with MULTILAM.

Type of termination:

- Crimp termination (C) for Cu conductors (class 5 and 6)
- Flow-soldering (PCB)

CT-BP1...



CT-SP1...



CT-E1-26/...

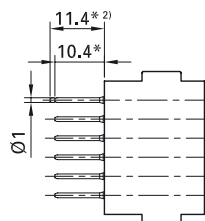

CT-E1-15/...

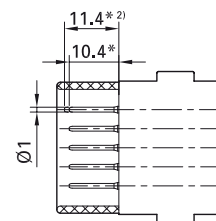

CT-E1-6

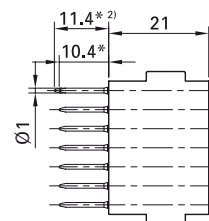

| Order No. | Type | Socket | Pin | Surface | Conductor cross section | | Rated current ¹⁾ | Type of termination |
|----------------|-------------------------------------|------------|-----|---------|-------------------------|-----|-----------------------------|-----------------------|
| | | | | | mm ² | AWG | | |
| 33.0141 | CT-BP1/0,25-0,75 AU | x | | | 0.25 | 24 | 2 | C |
| 33.0143 | CT-BP1ET/0,25-0,75 AU ³⁾ | x | | | 0.5 | 20 | 3 | |
| | | | | | 0.75 | 18 | 5 | |
| 33.0543 | CT-SP1/0,25-0,75L AU ²⁾ | | x | | 0.25 | 24 | 2 | PCB ³⁾ |
| 33.0541 | CT-SP1/0,25-0,75K AU | | x | | 0.5 | 20 | 3 | |
| | | | | | 0.75 | 18 | 5 | |
| 33.0145 | CT-B1/PCB AU | x | | | | | 5 | PCB ³⁾ |
| 33.0146 | CT-B1ET/PCB AU | x | | | | | 5 | |
| 33.0547 | CT-S1/PCB-L AU ²⁾ | | x | | | | 5 | PCB ³⁾ |
| 33.0545 | CT-S1/PCB-K AU | | x | | | | 5 | |
| 33.4051 | CT-BS1 | Blind plug | | | | | | |

| Technical data | | |
|--------------------------------|--|--------------------------|
| | CT-BP... & CT-B... | CT-BP1ET... & CT-B1ET... |
| Nominal-Ø socket/pin | 1 mm | 1 mm |
| Max. sliding force per contact | 2 N | 0.5 N |
| Contact resistance | < 1.6 mΩ | < 3 mΩ |
| Mating cycles | 5000 | 100,000 |
| Vibrations | 4.2 g/5 – 250 Hz (DIN EN 61373) 10 g/10 – 500 Hz (DIN EN 60068-2-6) | |
| Resistance to shocks | 30 g/18 ms (DIN EN 61373) | |



Assembly instructions MA213-01

www.staubli.com/electrical

* Pin size same for all types of terminations.

¹⁾ Rated current for fully occupied carriers. Derating diagrams for bundled leads, see pages 105 – 108.

²⁾ Longer type of pin mates first.

³⁾ For drilling plans, see assembly instructions MA213-01.

Ø 0.6 MM SIGNAL UNIT UP TO 6 A

Contact carriers CT-E0,6-20/...

20-pole contact carrier made of plastic. Different designs for pins and sockets. The inner wall of the pin carrier protects the contacts from mechanical damage. The contact

carrier is mechanically coded to prevent incorrect mating.

Note:

In combination with the contact carrier CT-E0,6-20/..., compensator CT-DIP1,3-3,4 might be needed to fill gaps in the CombiTac.

CT-E0,6-20/B

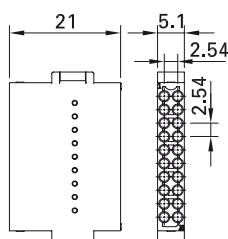

CT-E0,6-20/S

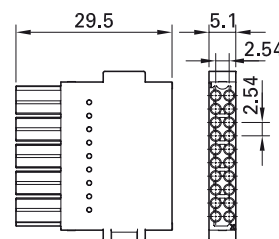

| Order No. | Type | Description |
|-----------|--------------|-------------------------------------|
| 33.4073 | CT-E0,6-20/B | Socket carrier (identification "B") |
| 33.4072 | CT-E0,6-20/S | Pin carrier (identification "S") |

| Technical data | | |
|---|-------------|------------|
| Number of poles | 20 | |
| For contact diameter | 0.6 mm | |
| Pollution degree / overvoltage category | 2/CATII | 3/CATIII |
| Voltage line / neutral | 150 V AC/DC | 50 V AC/DC |
| Degree of protection (socket front) | IP2X | |
| Limiting temperature (IEC 61984), upper | +90 °C | |
| lower | -40 °C | |
| Contact carrier material | LCP | |



Assembly instructions MA213-01

www.staubli.com/electrical

Ø 0.6 mm contacts

For contact carriers CT-E0,6-20/...

Type of termination:

- Crimp termination (C) for Cu conductors
- Soldering (L) for Cu conductors
- Flow-soldering (PCB) for printed circuit boards

CT-B...



CT-S...

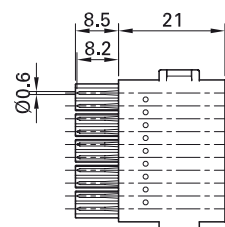

| Order No. | Type | Socket | Pin | Surface | Conductor cross section | | Rated current ¹⁾ | Type of termination |
|----------------------------------|--|--------|-----|---------|-------------------------|----------|-----------------------------|---------------------|
| | | | | | mm ² | AWG | | |
| 33.0126 33.0526 | CT-BP0,6ET/0,14-0,25 AU CT-SP0,6/0,14-0,25 AU | x | x | | 0.14 0.25 | 26 24 | 1.4 2 | C |
| 33.0125 33.0525 | CT-B0,6ET/LO AU CT-S0,6/LO AU | x | x | | 0.14 0.25 | 26 24 | 1.4 2 | L |
| 33.0124 33.0524 | CT-B0,6ET/PCB AU CT-S0,6/PCB AU | x | x | | 0.14 0.25 | 26 24 | 1.4 2 | PCB |

Technical data

| | |
|--------------------------------|---------|
| Nominal-Ø pin / socket | 0.6 mm |
| Max. sliding force per contact | 0.5 N |
| Contact resistance | < 6 mΩ |
| Mating cycles | 300,000 |

Accessories

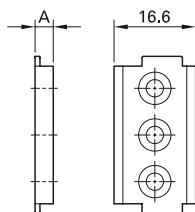

| Order No. | Type | Designation | Size A |
|----------------|---------------|-------------|-----------------|
| 33.4096 | CT-DIP1,3-3,4 | Compensator | 1.3 mm – 3.4 mm |



Assembly instructions MA213-01

www.staubli.com/electrical

¹⁾ Rated current for fully occupied carriers. Derating diagrams for bundled leads, see pages 104 – 108.

LAST MATE FIRST BREAK MODULE

Module CT-LMFB/...

Last Mate First Break (LMFB) contacts are intended for monitoring purposes, and show whether a CombiTac is fully connected or not. Each CombiTac LMFB module consists

of two LMFB contacts placed at the edge positions of a carrier.

Suitable for panel mount applications and housing sizes 2 to 5.

CT-LMFB/B

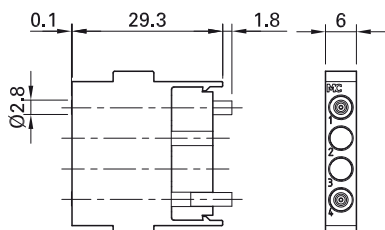

CT-LMFB/S

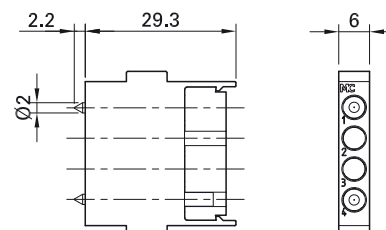

| Order No. | Type | Description |
|-----------|-----------|---------------|
| 33.2257 | CT-LMFB/B | Socket module |
| 33.2657 | CT-LMFB/S | Pin module |

Technical data

| | |
|---|--------|
| Contact carrier material | PA |
| Limiting temperature (IEC 61984), upper | +90 °C |
| lower | -40 °C |

Rails ≤ 90 mm¹⁾



Assembly instructions MA213-07

www.staubli.com/electrical

Last Mate First Break contacts CT-LMFB-...

To be used with contact carrier CT-E-4GOF for monitoring the connection status of electrical contacts Ø 1.5 mm – Ø 12 mm.

Type of termination:

- Crimp termination (C) for Cu conductors (class 5)
- Pressure contacts fitted with MULTILAM

CT-LMFB-B2/0,5-1,5 AU

CT-LMFB-S2/0,5-1,5 AU

Socket side

Pin side

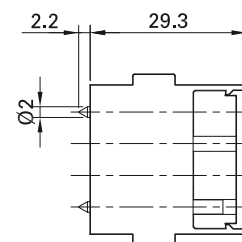
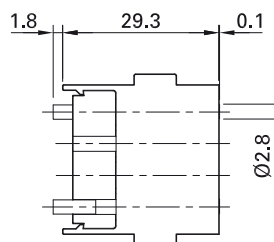

| Order No. | Type | Socket | Pin | Surface | Conductor cross section | | Type of termination |
|-----------|------------------------|------------|-----|---------|-------------------------|-----|---------------------|
| | | | | | mm ² | AWG | |
| 33.0134 | CT-LMFB-B2/0,5-1,5 AU | x | x | | 0.5 | 20 | |
| 33.0534 | CT-LMFB-S2/0,5-1,5 AU | | | | 0.75 | 18 | |
| | | | | | 1.0 | 18 | |
| | | | | | 1.5 | 16 | |
| 33.4080 | CT-BSGOF ²⁾ | Blind plug | | | | | |

| Technical data | |
|------------------------------|------------------------------|
| Rated voltage/system voltage | 29.5 V DC |
| Max. signal current | 100 mA |
| Max. sliding force | 14 N |
| Mating cycles | 100,000 ³⁾ |
| Vibrations | 3.1 g/5 – 250 Hz (IEC 61373) |
| Resistance to shocks | 30 g/18 ms (IEC 61373) |

¹⁾ Please consult Stäubli sales team regarding LMFB modules for Rails > 90 mm

²⁾ We recommend filling the two empty slots of the contact carrier with blind plugs.

³⁾ LMFB contacts are not suitable for inductive (e.g. relays) or capacitive loads. In such cases, arcing at the LMFB contacts during connecting/disconnecting may reduce the expected mating cycles of LMFB contacts.



Assembly instructions MA213-07

www.staubli.com/electrical

COAXIAL UNIT 6 GHz

Contact carrier

The Coaxial unit 6 GHz is used for data as well as digital audio and video transmission. Two types of termination are possible, crimp and SMA.

There are two crimp versions available, one for RG58 and one for RG316/U, RG174 and RG188 cables, and a SMA termination version for various cable types up to 6 GHz levels.

Features:

- Suitable for various 50 Ω RG cable types up to 6 GHz (depending on RG cable type)
- Crimp for RG58 cables up to 2.4 GHz
- Crimp for RG316/U, RG174, RG188 cables up to 2.4 GHz
- SMA for RG58, RG316/U, RG174, RG188 and other cables up to 6 GHz
- 100,000 mating cycles
- UL 1977 and Railway standard compliant
- Resistance to shock and vibrations
- Applications: data transmission, digital audio and video, HF measurement, radio communication.

CT-E-COAX-1

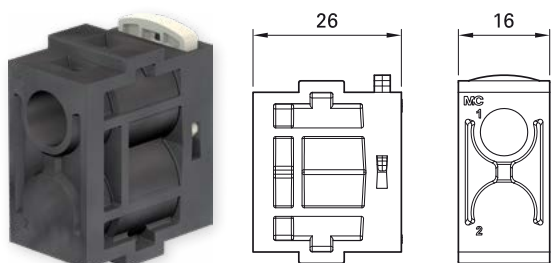

CT-E-COAX-2

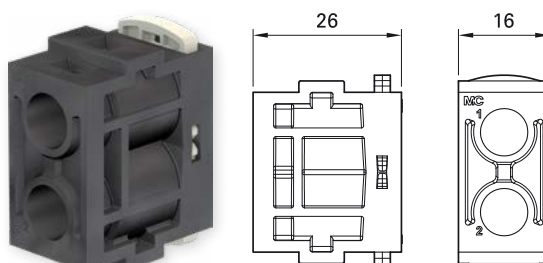

CT-RC-COAX



| Order No. | Type | Designation |
|-----------|-------------|-----------------------|
| 33.4180 | CT-E-COAX-1 | One pole coax carrier |
| 33.4181 | CT-E-COAX-2 | Two pole coax carrier |

Individual part (supplied with 33.4180 and 33.4181)

| | | |
|---------|------------|---|
| 33.4182 | CT-RC-COAX | Retaining clip (included with carriers) |
|---------|------------|---|

| Technical data | |
|----------------------------------|----------------------------|
| Number of poles CT-E-COAX-1 | 1 |
| CT-E-COAX-2 | 2 |
| For connectors | Coaxial crimp and SMA |
| Pollution degree | 2 |
| Limiting temperature (IEC 61984) | -40 °C...+90 °C |
| Contact carrier material | PA |
| Fire and smoke compliance | EN 45545-2 (HL3 R22 – R23) |



Assembly instructions MA213-11

www.staubli.com/electrical

Coaxial connectors

For contact carriers CT-E-COAX-1 and CT-E-COAX-2.

Type of termination:

- Crimp termination (C)
- SMA Termination (SMA)

CT-B-COAX-RG316/U



CT-S-COAX-RG316/U

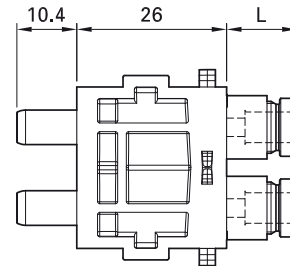

| Order No. | Type | Socket | Pin | Suitable for cable types | Type of termination |
|--------------------|--|--------|-----|---|---------------------|
| 33.0230 33.0630 | CT-B-COAX-RG316/U CT-S-COAX-RG316/U | × | × | RG316/U, RG174, RG188 | C |
| 33.0231 33.0631 | CT-B-COAX-RG58 CT-S-COAX-RG58 | × | × | RG58 | C |
| 33.0250 33.0750 | CT-B-COAX-SMA CT-S-COAX-SMA | × | × | RG58, RG316/U, RG174, RG188, other 50 Ω RG cable types up to 6 GHz | SMA |

| Technical data | |
|-------------------------------------|--|
| Max. sliding force per contact | 9 N |
| Max. frequency | Crimp: 2.4 GHz SMA: 6 GHz |
| Voltage standing wave ratio (VSWR) | Crimp: 1.4 at 2.4 GHz SMA: 1.3 at 6 GHz |
| Rated voltage | UL 250 V, IEC 300 V |
| Rated current | 250 mA |
| Impedance | 50 Ω |
| Mating cycles | 100,000 |
| Vibrations and shock | IEC 61373 category 1B |
| Degree of protection (socket front) | IP2X |



Assembly instructions MA213-11

www.staubli.com/electrical

COAXIAL UNIT 1.5 GHZ

Contact carrier CT-E8-2

2-pole contact carrier made of resilient plastic.

CT-E8-2

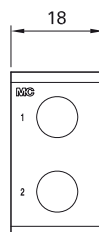
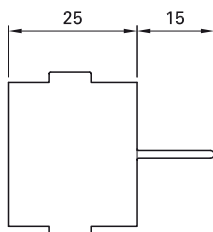

| Order No. | Type |
|-----------|---------|
| 33.4000 | CT-E8-2 |

| Technical data | |
|---|---------|
| Number of poles | 2 |
| For connectors | Coaxial |
| Pollution degree | 2 |
| Limiting temperature (IEC 61984), upper | +90 °C |
| lower | -40 °C |
| Contact carrier material | EPTR |



Assembly instructions MA213-02

www.staubli.com/electrical

Coaxial connectors

For contact carrier CT-E8-2. Consist of parts of BNC plug connectors. For coaxial cables type RG58¹⁾ and RG59¹⁾.

Type of termination:
Crimp termination (C) of the inner conductor and the shield

Notes:
For the termination of the shield, a brass crimping sleeve is included. The coaxial plug connectors are designed in accordance with CECC 22 120.

CT-B/COAX58



CT-S/COAX58



CT-B/COAX59



CT-S/COAX59

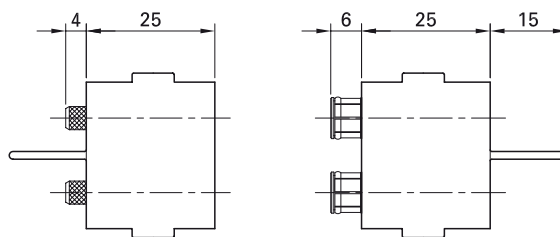

| Order No. | Type | Socket | Pin | Inner-Ø crimp sleeve shield | Type of termination |
|-----------|---------------------------|------------|-----|-----------------------------|---------------------|
| 33.0160 | CT-B/COAX58 | × | | 5.5 mm | C |
| 33.0560 | CT-S/COAX58 | | × | 5.5 mm | C |
| 33.0161 | CT-B/COAX59 ²⁾ | × | | 6.5 mm | C |
| 33.0561 | CT-S/COAX59 ²⁾ | | × | 6.5 mm | C |
| 33.4050 | CT-BS8 | Blind plug | | | |

| Technical data | |
|---|---|
| Max. sliding force per contact | 20 N |
| Surface inner conductor | CuZn, Au |
| Surface shield | CuZn, Ni |
| Voltage standing wave ratio | CT...58: VSWR ≤ 1.25 at f < 1.5 GHz CT...59: VSWR ≤ 1.5 at f < 500 MHz |
| Rated voltage shield/earth | 1000 V, CAT II |
| Rated voltage inner conductor/shield | 1000 V, CAT II |
| Impedance | CT...58: 50 Ω CT...59: 75 Ω |
| Voltage level according to | IEC 61010 |
| Mating cycles according to DIN EN 61169-8 - 2007-11 | 5,000 2,500 |

¹⁾ For the coaxial connectors CT-.../COAX58 and CT-.../COAX59, only the coaxial lead RG58 or RG59 is suitable.
²⁾ CT59: if a solid conductor is used, this must be soldered.

DATA TRANSFER UNIT

Contact carrier for data transfer in BUS-Systems CT-NET-...

Contact carrier made of plastic. One or two 8-pole pin or socket carriers with continuous shielding.

CT-NET-1/B



CT-NET-1/S

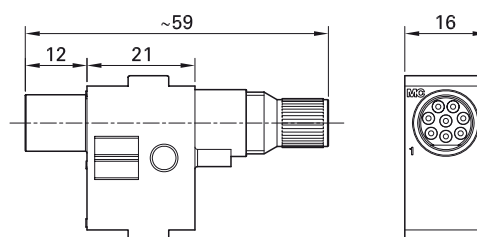

CT-NET-2/B



CT-NET-2/S

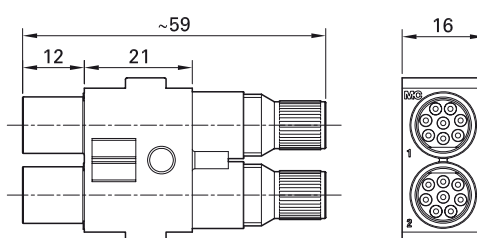

| Order No. | Type | Number of contact elements |
|-----------|------------|---|
| 33.2240 | CT-NET-2/B | Depending on contact arrangement on page 43; must be ordered separately |
| 33.2540 | CT-NET-2/S | |
| 33.2241 | CT-NET-1/B | |
| 33.2641 | CT-NET-1/S | |

| Technical data | |
|--|---|
| Data transmission | CAT5 Ethernet IEEE 802.3, Profibus, Profinet, Interbus, CAN-BUS |
| Mating cycles | 5000 |
| Limiting temperature (IEC 61984), upper lower | +90 °C -40 °C |
| Contact carrier material insulation | PA PEEK |



Assembly instructions MA213-04

www.staubli.com/electrical

Contacts for data transmission in BUS system CT-NET-...

For contact carrier CT-NET-... Sockets fitted with MULTILAM.

Type of termination:
Crimp termination (C) to a Cu conductor (class 5 and 6)

CT-NET-B...



CT-NET-S...

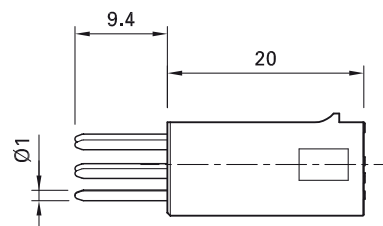
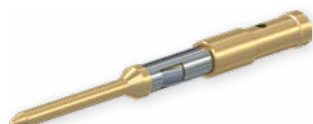

| Order No. | Type | Socket | Pin | Surface | Conductor cross section | | Rated current | Type of termination |
|-----------|---------------------------|------------|-----|---------|-------------------------|-----|---------------|---------------------|
| | | | | | mm ² | AWG | | |
| 33.0148 | CT-NET-BP1ET/0,25-0,75 AU | x | | | 0.25 | 24 | 2 | C |
| | | | | | 0.5 | 20 | 3 | |
| | | | | | 0.75 | 18 | 5 | |
| 33.0548 | CT-NET-SP1/0,25-0,75 AU | | x | | 0.25 | 24 | 2 | |
| | | | | | 0.5 | 20 | 3 | |
| | | | | | 0.75 | 18 | 5 | |
| 33.9589 | CT-NET-BS ¹⁾ | Blind plug | | | | | | |

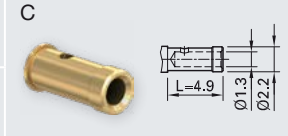

| Technical data | |
|--------------------------------|--------|
| Nominal-Ø socket/pin | Ø 1 mm |
| Max. sliding force per contact | 1 N |
| Contact resistance | 1.6 mΩ |

Contact arrangement of the contact carrier

Left: socket side; right: pin side
(Viewed from the termination side)

Ethernet / Profinet

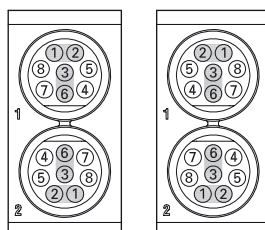

Interbus

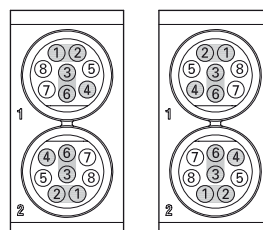

Profibus

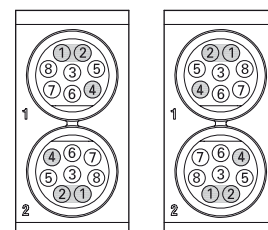

¹⁾ Unused contact chambers should be closed with blind plugs.



Assembly instructions MA213-04

www.staubli.com/electrical

10Gbit module CT-10GBIT-...

The 10Gbit module is used for Ethernet communication up to 10Gbit (CAT6A).

Two versions are available, one for RJ45 and one for M12 (x-coded) connection.

The 10Gbit module is delivered completely assembled.

- Suitable for RJ45 and M12 connection
- 100,000 mating cycles
- UL 1977 and Railway standard compliant
- Resistance to shock (M12) and vibrations (M12, RJ45)

- Applications: high speed data communication, machine-to-machine communication (M2M), real time facility data sharing, railway

CT-10GBIT-RJ45/B



Rear view

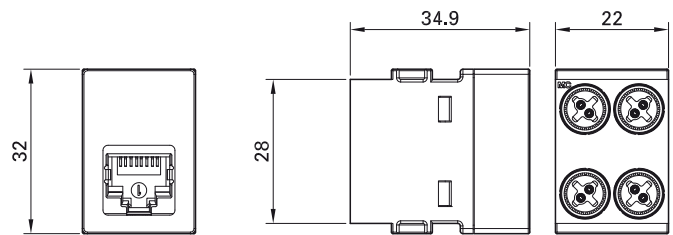

CT-10GBIT-RJ45/S



Rear view

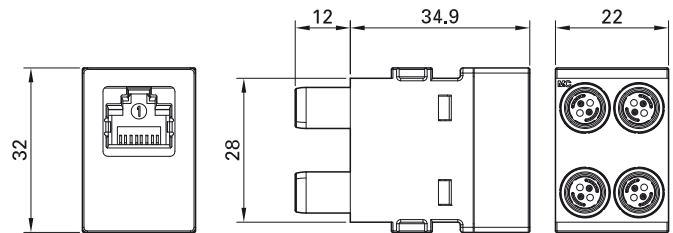

CT-10GBIT-M12/B



Rear view

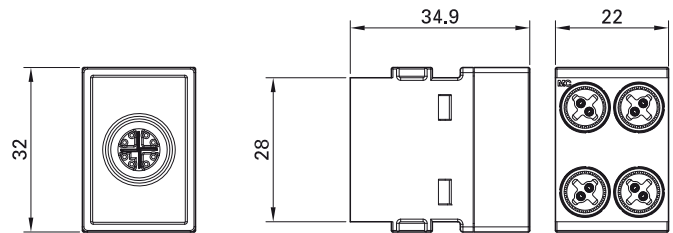

CT-10GBIT-M12/S



Rear view

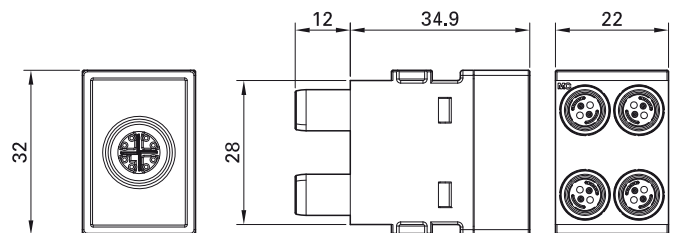

| Order No. | Type |
|----------------|------------------|
| 33.0130 | CT-10GBIT-RJ45/B |
| 33.0530 | CT-10GBIT-RJ45/S |
| 33.0240 | CT-10GBIT-M12/B |
| 33.0640 | CT-10GBIT-M12/S |

| Technical data | |
|--|--|
| Data transmission | CAT6A Ethernet IEEE 802.3an |
| Mating cycles | 100,000 |
| Rated current | 0.75 A |
| Rated voltage ¹⁾ | 48 V |
| Limiting temperature (IEC 61984), upper lower | +90 °C -40 °C |
| Contact carrier material | PA |
| Fire and smoke compliance | EN 45545-2 (HL3 R22 – R23) |
| Insulation resistance | ≥ 500 MΩ |
| Vibrations, RJ45 M12 | 5 g/10 – 500 Hz (IEC 60512-6-4) 0.58 g/5 - 150 Hz (IEC 61373 category 1B) |
| Resistance to shocks, M12 | 3.06 g/30 ms (IEC 61373 category 1B) |

¹⁾ Less than 30 V_{rms} for UL 1977



Assembly instructions MA213-08

www.staubli.com/electrical

10Mbit module CT-RJ45/...

The 10Mbit module is used for Ethernet communication up to 10Mbit (CAT5).

Suitable network cables with a RJ45 connectors can be directly connected to the

10Mbit module. The 10Mbit module is delivered completely assembled.

CT-RJ45/B



View from rear view

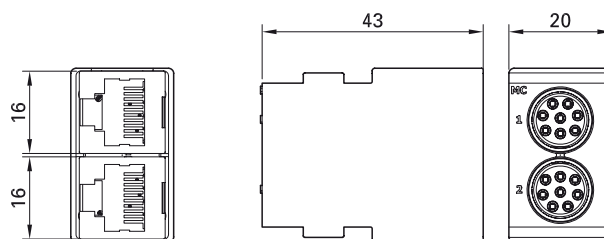

CT-RJ45/S



View from rear view

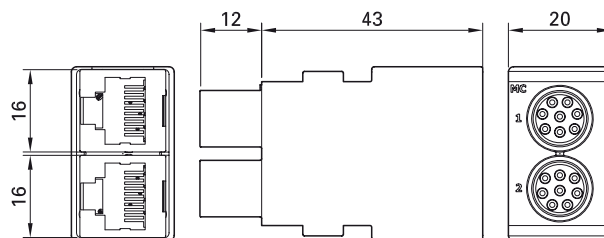

| Order No. | Type |
|-----------|-----------|
| 33.2169 | CT-RJ45/B |
| 33.2170 | CT-RJ45/S |

| Technical data | |
|--|--------------------------|
| Data transmission | CAT5 Ethernet IEEE 802.3 |
| Mating cycles | 5,000 |
| Limiting temperature (IEC 61984), upper lower | +90 °C -40 °C |
| Contact carrier material | PA |
| Insulation | PEEK |

Attenuation characteristics for CT-NET...

Attenuation characteristics for CT-RJ45...

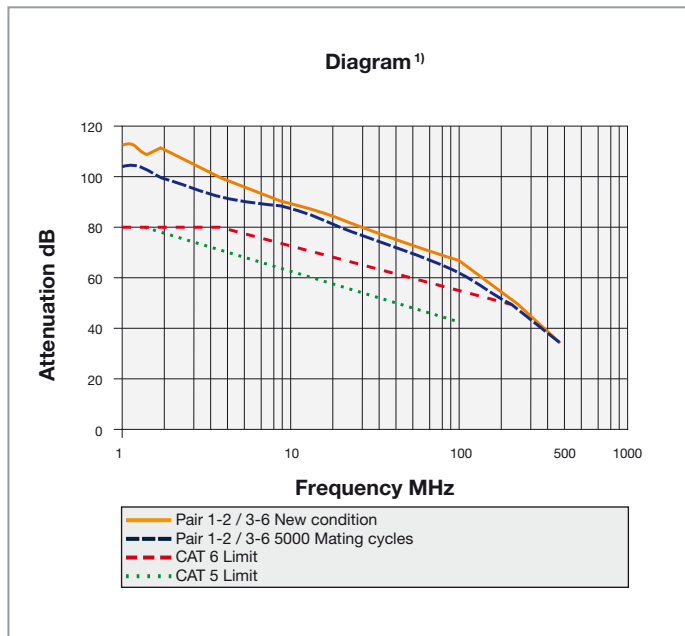
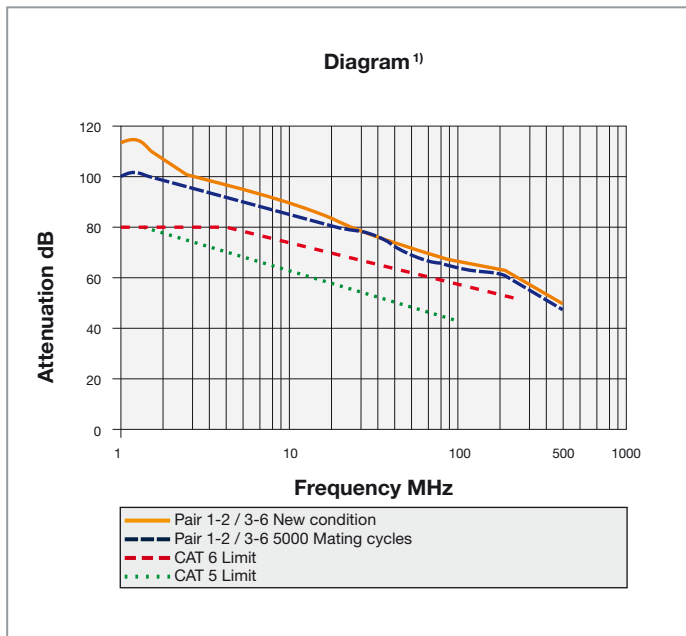

Attenuation characteristics for CT-10GBIT-...

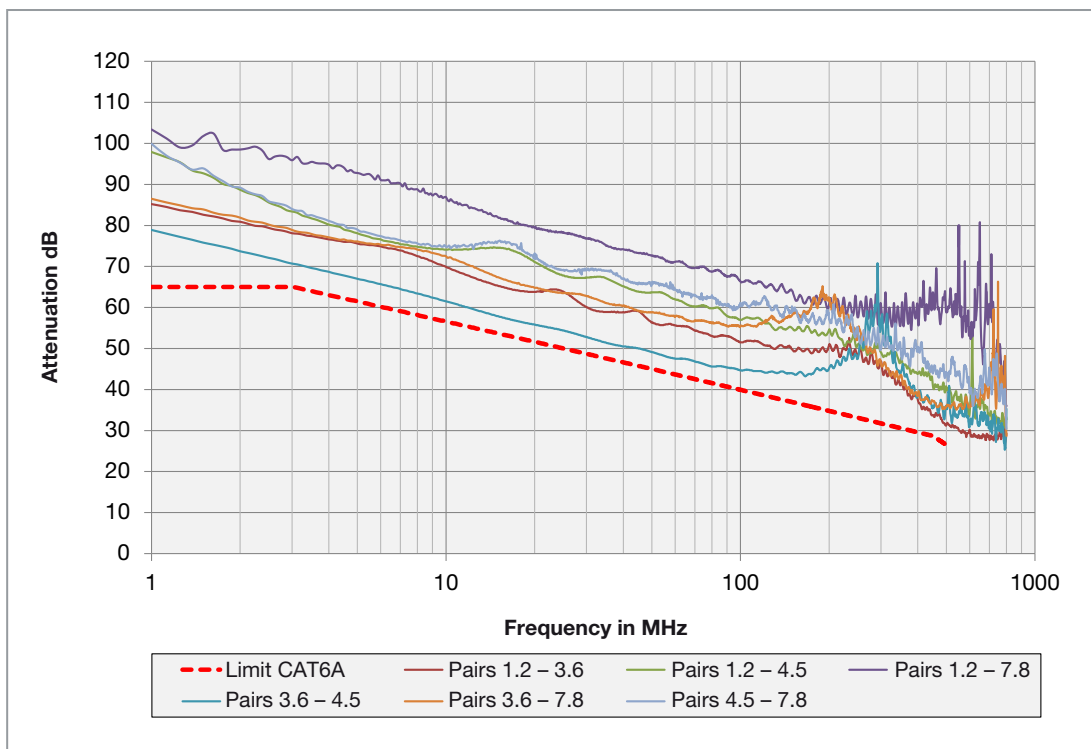

1) Further technical specifications:
www.staubli.com/electrical > Downloads > Technical Info > Industry > Data connectors.

OPTICAL FIBER UNIT POF

Contact carriers CT-E-3POF/...

3-pole contact carrier made of plastic. Different designs for pins and sockets.

Because of the spring-loaded contacts, the contact carriers must be installed either in a

housing or with a locking system defined by the customer.

CT-E-3POF/B

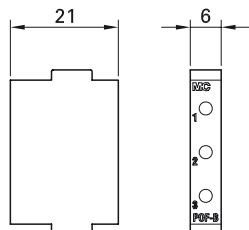

CT-E-3POF/S

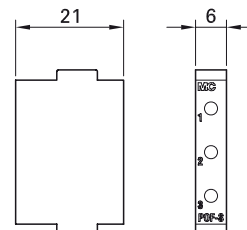

| Order No. | Type | Description |
|-----------|-------------|-------------------------------------|
| 33.4016 | CT-E-3POF/B | Socket carrier (identification "B") |
| 33.4017 | CT-E-3POF/S | Pin carrier (identification "S") |

| Technical data | |
|---|------------|
| Number of poles | 3 |
| For connector type | POF Ø 1 mm |
| Limiting temperature (IEC 61984), upper | +90 °C |
| lower | -40 °C |
| Contact carrier material | PA |

Contact carriers CT-E6-2

2-pole contact carrier in plastic for plastic optical fiber with lens, type CT-POF/SL.

CT-E6-2

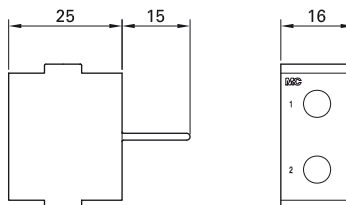

| Order No. | Type |
|-----------|---------|
| 33.4006 | CT-E6-2 |

| Technical data | |
|---|------------|
| Number of poles | 2 |
| For connector type | POF Ø 1 mm |
| Limiting temperature (IEC 61984), upper | +90 °C |
| lower | -40 °C |
| Contact carrier material | EPTR |



Assembly instructions MA213-03

www.staubli.com/electrical

Plastic optical fiber contacts CT-.../POF

For the connection of plastic optical fiber cables of the type POF Multimode. Standard version or lens version.

Advantages of lens version CT-POF/SL:

- Higher tolerance against dirt
- Easy to clean
- Same type for both mating sides

CT-B/POF



CT-S/POF



CT-POF/SL

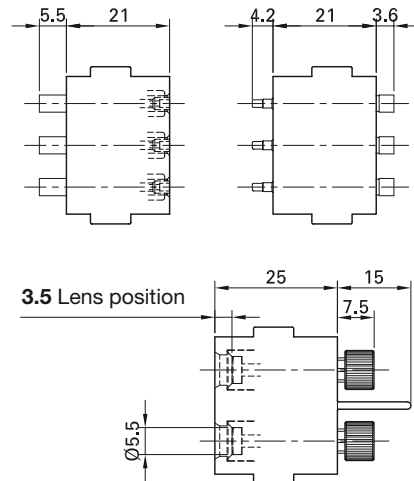

| Order No. | Type | Socket | Pin | For contact carrier |
|-----------|-----------|--------|-----|---------------------|
| 33.0170 | CT-B/POF | x | | CT-E-3POF/B |
| 33.0570 | CT-S/POF | | x | CT-E-3POF/S |
| 33.0370 | CT-POF/SL | x | x | CT-E6-2 |

| Technical data | |
|-----------------------------------|--|
| Ø of core/cladding | 980/1000 µm |
| Ø of first protective covering | 2200 µm |
| Insertion loss CT-B/POF, CT-S/POF | < 3 dB at 650 nm, depending on assembly type |
| Bandwidth length product MHz | 1 km at 650 nm |
| Numeric aperture | 0.47 |
| Insertion loss CT-POF/SL | < 3 dB at 650 nm |
| Mating cycles | 500 |



Assembly instructions MA213-03

www.staubli.com/electrical

OPTICAL FIBER UNIT GOF

Contact carrier CT-E-4GOF

4-pole contact carrier made of plastic.

CT-E-4GOF

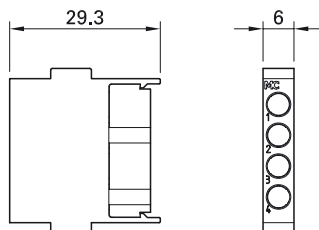

| Order No. | Type |
|-----------|-----------|
| 33.4065 | CT-E-4GOF |

| Technical data | |
|--------------------------|----|
| Contact carrier material | PA |

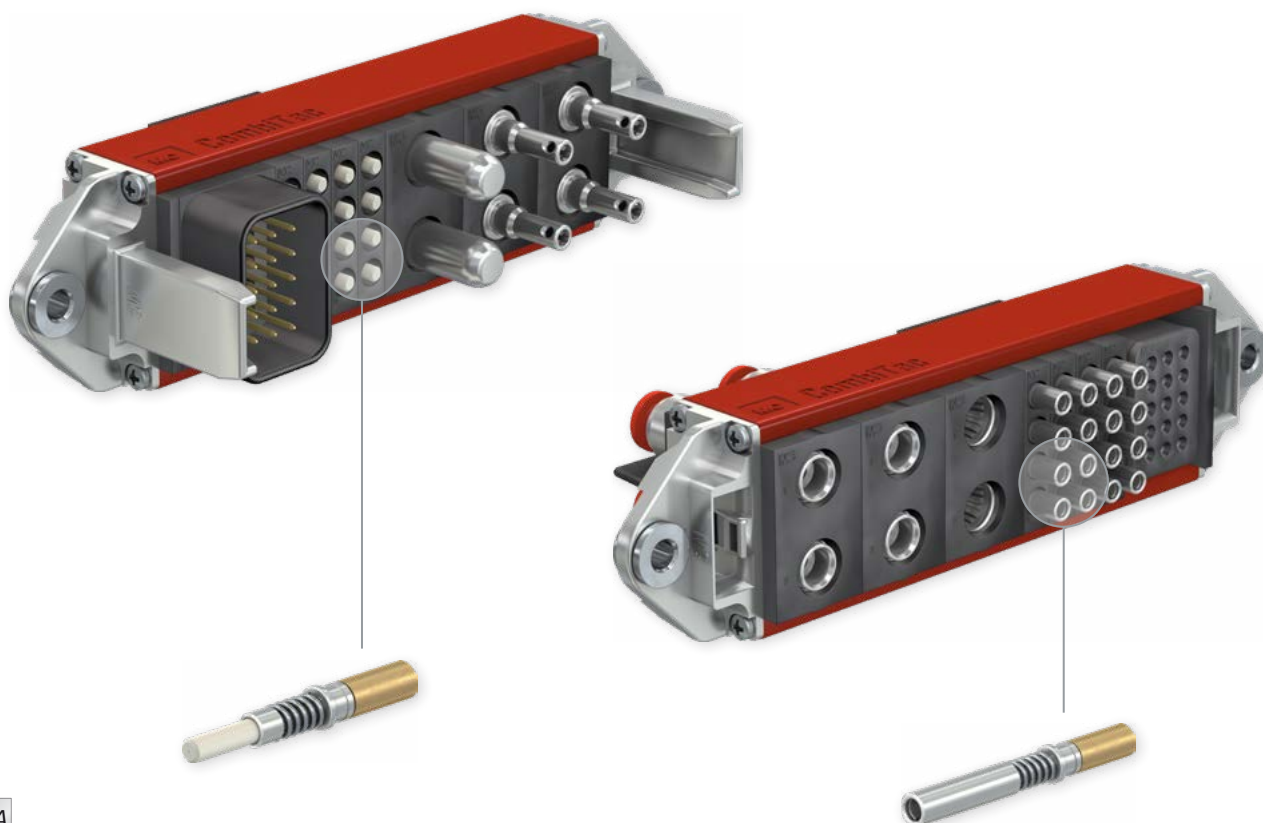

Assembly instructions MA213-06, MA092

www.staubli.com/electrical

Glass optical fiber contacts CT-.../GOF

For the connection of glass optical fiber cables of the type GOF Mono- and Multimode, to fit contact carrier CT-E-4GOF.

In preassembled cables, one end is equipped with either ST or SC plug connectors according to choice. The cable length

is 1 m. Fiber type: Multimode, gradient fiber (GI) 50/125 μm .

CT-B/GOF



CT-S/GOF



Socket side

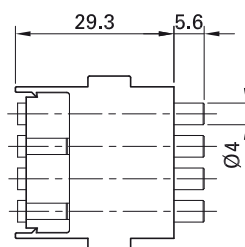

Pin side

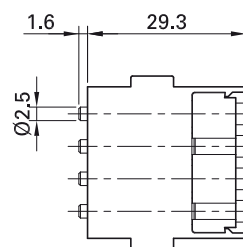

CT-B/GOF-100-ST

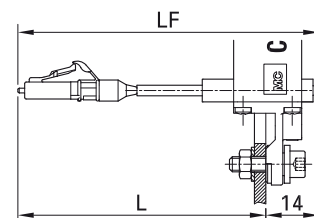
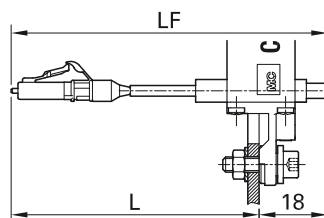

| Order No. | Type | Socket | Pin | Designation | on tail end preassembled with |
|-------------|-------------------------------|--------|-----|----------------------------------|-------------------------------|
| 33.0171 | CT-B/GOF | x | | Contact | |
| 33.0571 | CT-S/GOF | | x | Contact | |
| 33.0171-100 | CT-B/GOF-100-ST ¹⁾ | x | | 1 m Preassembled multimode cable | ST |
| 33.0571-100 | CT-S/GOF-100-ST ¹⁾ | | x | 1 m Preassembled multimode cable | ST |
| 33.0172-100 | CT-B/GOF-100-SC ¹⁾ | x | | 1 m Preassembled multimode cable | SC |
| 33.0572-100 | CT-S/GOF-100-SC ¹⁾ | | x | 1 m Preassembled multimode cable | SC |

Technical data

| | |
|---------------------------------|--|
| Insertion loss | <0.5 dB at 1310 nm, depending on assembly type |
| Mating cycles | ≥ 500 (cleaning interval every 100 mating cycles) ²⁾ |
| Spring deflection | 3 mm |
| Contact pressure | 10 N per contact with 3 mm spring deflection |
| Allowable operating temperature | -30 °C ... +90 °C |

Fiber types

| | |
|-------------------------|------------------------|
| Graded-index fiber (GI) | 50/125 μm |
| Graded-index fiber (GI) | 62.5/125 μm |
| Single mode fiber (SM) | 9/125 μm |
| Coating diameter | 250/900 μm |
| Ø of cable | max. 3 mm |

LF= total length.

L = length from CombiTac mounting position.

¹⁾ Other cable lengths and connectors on request. Specify L or LF length.

²⁾ Cleaning the contact surface at regular intervals increases the number of mating cycles.



Assembly instructions MA213-06, MA092

www.staubli.com/electrical

THERMOCOUPLE UNIT

Thermocouple pressure contacts

Thermocouple allows for the precise measurement of temperatures. Between two wires of different materials a voltage is generated that varies according to the rise in temperature.

The electrical measurement of temperature requires that the entire measurement chain (temperature sensor, cable connection points) consists of the same combination of materials. Using a uniform material pre-

vents thermal imbalances in the case of the connection of two parts with the same initial temperature.

With Stäubli thermocouple contacts, you can extend the measurement chains or lay them out as plug contact connections.

There are several types of thermocouples made from different materials adapted to the measured temperature range.

Stäubli thermocouple pressure contacts are available for 5 different types of sensor: E, J, K, N, and T. For that reason, Stäubli has developed different types of spring loaded contacts for thermocouples from the 7 most commonly used materials: chromel, constantan, iron, alumel, nicrosil, nilsil, and copper.

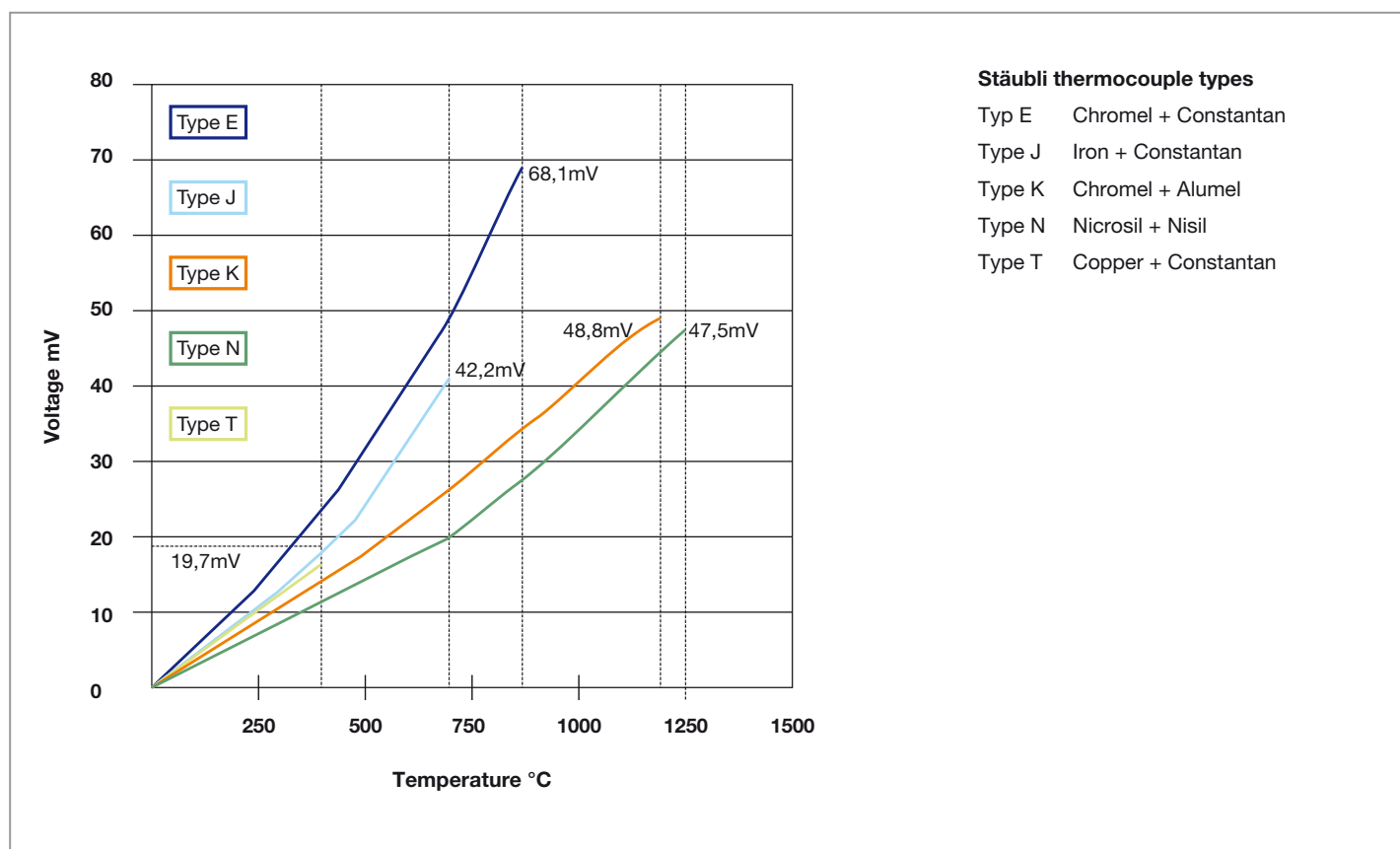

Description according to: EN60584

To ensure clear identification, our spring-loaded thermocouple contacts are provided with different grooves and markings:

Cu
Copper (without groove)



Fe
Iron (without groove)



NiAl
Alumel® (1 groove)



NiCr
Chromel® (2 grooves)



NiSi
Nisil (3 grooves)



NiCrSi
Nicrosil (4 grooves)



CuNi
Constantan® (1 wide groove)



Material marking

Groove

Contact carrier CT-E-2TH+PE/...

3-pole contact carrier made of plastic. For two thermocouple pressure contacts and one PE contact.

Different designs for pins and sockets. Because of the springloaded contacts, the contact carriers must be installed either in

a housing or with a locking system defined by the customer.

CT-E-2TH+PE/B

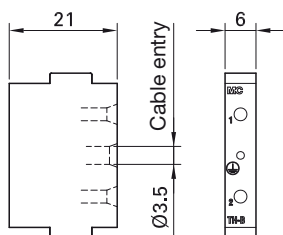

CT-E-2TH+PE/S

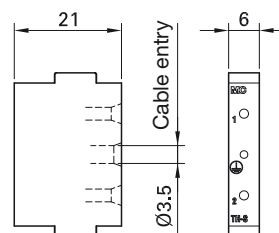

| Order No. | Type | Description |
|-----------|---------------|-------------------------------------|
| 33.4011 | CT-E-2TH+PE/B | Socket carrier (identification "B") |
| 33.4012 | CT-E-2TH+PE/S | Pin carrier (identification "S") |

Technical data

| | |
|--------------------------|----------------------------------|
| Number of poles | 1 thermocouple (2 contacts)/1 PE |
| Contact carrier material | EPTR |



Assembly instructions MA213-01

www.staubli.com/electrical

Thermocouple pressure contacts

For the connection of measurement chains for thermocouple, for contact carriers CT-E-2TH+PE/...

Type of termination:
Crimp termination

Note:
Soldering is not permitted, meaning that only uniform materials are used. **This ensures a homogeneous measurement chain.**

DBP2-...

DSP2-...

CT-BP1,5LAV/0,5-1,5 AU

CT-SP1,5/0,5-1,5K AU

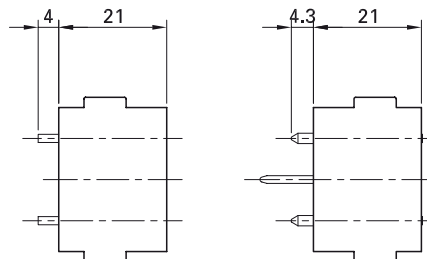

| Order No. | Type | Socket | Pin | Material | Material marking | Groove marking | PE contact | Crimp termination | |
|-----------|------------------------|------------|-----|------------|------------------|----------------|------------|-------------------|---|
| 19.6724 | DBP2-NISI/0,14-0,5 | x | x | Nisil | NIS | | | | |
| 19.6723 | DSP2-NISI/0,14-0,5 | | | | | | | | |
| 19.6722 | DBP2-NICRSI/0,14-0,5 | x | x | Nicrosil | NIC | | | | |
| 19.6721 | DSP2-NICRSI/0,14-0,5 | | | | | | | | |
| 19.6726 | DBP2-CU/0,14-0,5 | x | x | Copper | CU | | | | |
| 19.6725 | DSP2-CU/0,14-0,5 | | | | | | | | |
| 19.6720 | DBP2-FE/0,14-0,5 | x | x | Iron | FE | | | | |
| 19.6719 | DSP2-FE/0,14-0,5 | | | | | | | | |
| 19.6718 | DBP2-CO/0,14-0,5 | x | x | Constantan | CO | | | | |
| 19.6717 | DSP2-CO/0,14-0,5 | | | | | | | | |
| 18.8062 | DBP2-AL/0,14-0,5 | x | x | Alumel | AL | | | | |
| 18.9062 | DSP2-AL/0,14-0,5 | | | | | | | | |
| 18.8063 | DBP2-CR/0,14-0,5 | x | x | Chromel | CR | | | | |
| 18.9063 | DSP2-CR/0,14-0,5 | | | | | | | | |
| 33.0153 | CT-BP1,5LAV/0,5-1,5 AU | x | x | CuZn, Au | | | x | | |
| 33.0550 | CT-SP1,5/0,5-1,5K AU | | | | | | | | x |
| 18.5500 | MVS1,5/2 | Blind plug | | | | | | | |

| Technical data | |
|--|--|
| For conductor cross section | 0.14 mm ² – 0.5 mm ² ¹⁾ |
| Contact pressure (spring insertion 1 mm) | 6 – 9 N |
| Mating cycles | 100,000 ²⁾ |



Assembly instructions MA213-01

www.staubli.com/electrical

¹⁾ Contacts for conductor cross section 0.5 mm² – 1 mm² on request.

²⁾ Maintenance interval: every 10,000 or 50,000 cycles depending on thermocouple type, see MA213.

PNEUMATIC AND FLUID UNITS

Compressed air and vacuum modules

RCT 03:

- Nominal width: 3 mm
- With shut-off on one side or without shut-off valve

RCT 06:

- Nominal width: 6 mm
- With shut-off on one side or without shut-off valve

UCT:

- Nominal widths: 4 mm, 6 mm, and 8 mm
- Without shut-off valve

RCT



UCT



Coolant modules

- Nominal widths: 3 mm and 5 mm
- Leakproof rapid couplings
- With shut-off on both sides

SCT



The compressed air and coolant couplers are supplied ready mounted in the carrier.

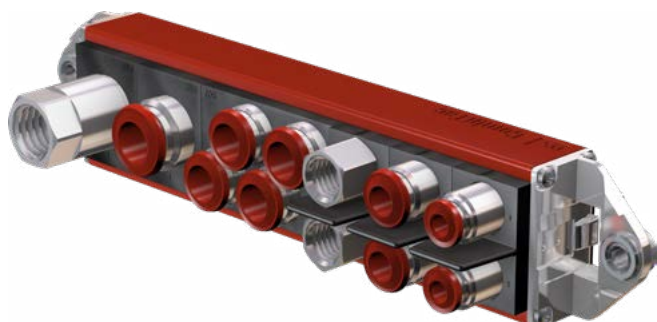

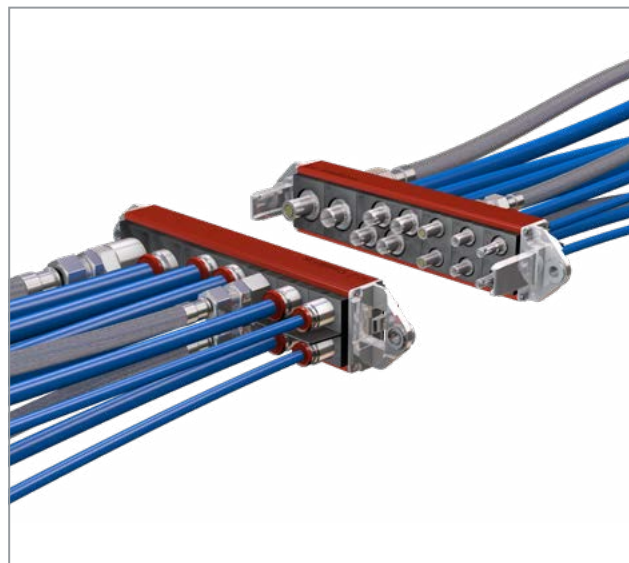
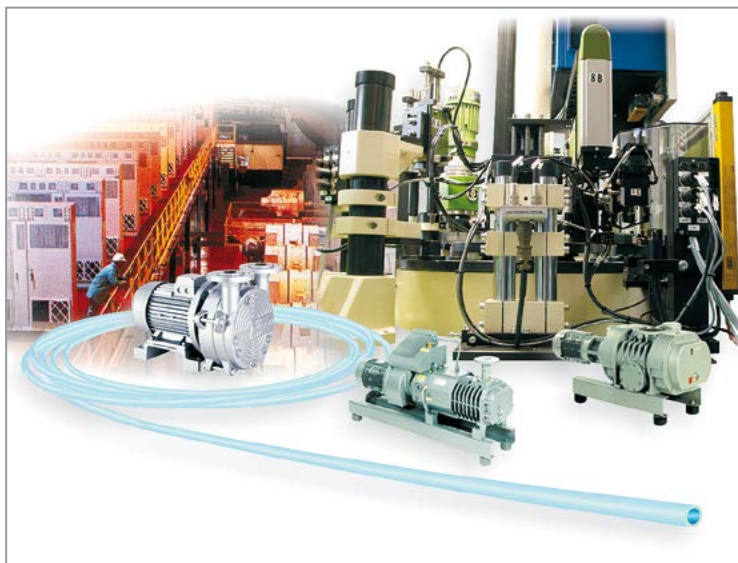

8 different sizes of carriers

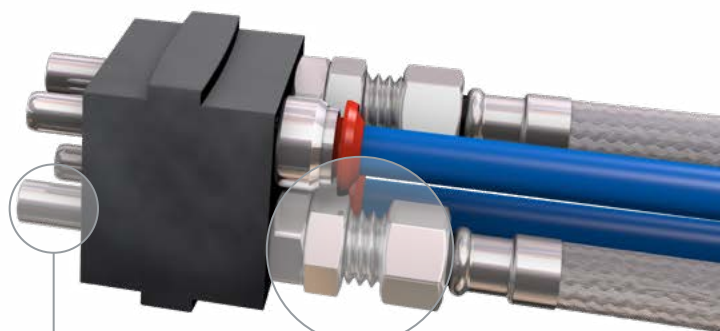

Colored press rings for simple assignment

- Metric termination without shut-off
- Metric termination with shut-off
- Inch termination without shut-off
- Inch termination with shut-off

Brass, nickel plated

14 plug types

17 socket types

15 bar max. operating pressure

Recommended calibrated plastic tubes:
 TUBANE Stäubli (PU)
 RILFLEX Stäubli (PA)
 See catalog "Tuyaux flexibles (flexible hoses)" from Stäubli

COMPRESSED AIR – VACUUM UNIT

Carriers for compressed air and coolant couplings CT-E8...

2- and 4-pole carriers made of resilient plastic.

CT-E8-2

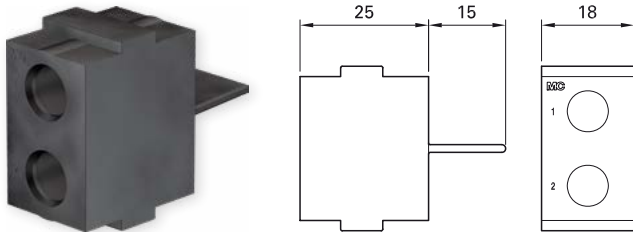

CT-E8-4/B

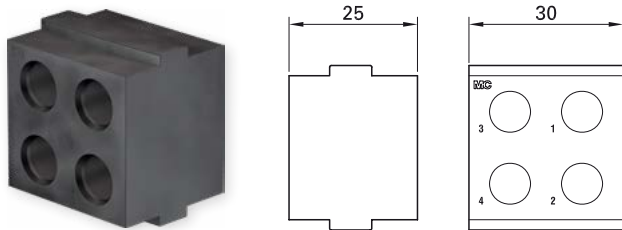

CT-E8-4/S

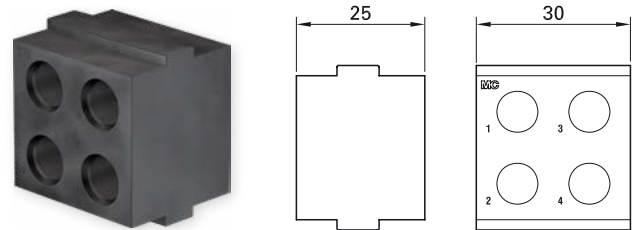

| Order No. | Type | Number of poles | For sockets | For plugs |
|-----------|-----------|-----------------|-------------|-----------|
| 33.4000 | CT-E8-2 | 2 | x | x |
| 33.4024 | CT-E8-4/B | 4 | x | |
| 33.4027 | CT-E8-4/S | 4 | | x |

Technical data

| | |
|--------------------------|------|
| Contact carrier material | EPTR |
|--------------------------|------|

Technical data from page 59:

Technical data

| | RCT03 | UCT04 |
|------------------------------|-----------------------|-------|
| Nominal bore (mm) | 03 | 04 |
| Max. working pressure (bar) | 15 | |
| Min. working pressure (mbar) | 14 | |
| Operating temperatures | -15 °C ... +90 °C | |
| Sealing materials | NBR | |
| Mating cycles | 100,000 ²⁾ | |

Compressed air couplings CT-...-RCT03/... and CT-...-UCT04/...

For carriers CT-E8...

Type of termination:

Clamping and PLV screw connection for calibrated plastic tubes (PA or PU)

CT-B...-RCT03/...



CT-S...-RCT03/...



CT-B-UCT04/...



CT-S-UCT04/...



CT-BV-RCT03/PLV4/6



CT-S-RCT03/PLV4/6

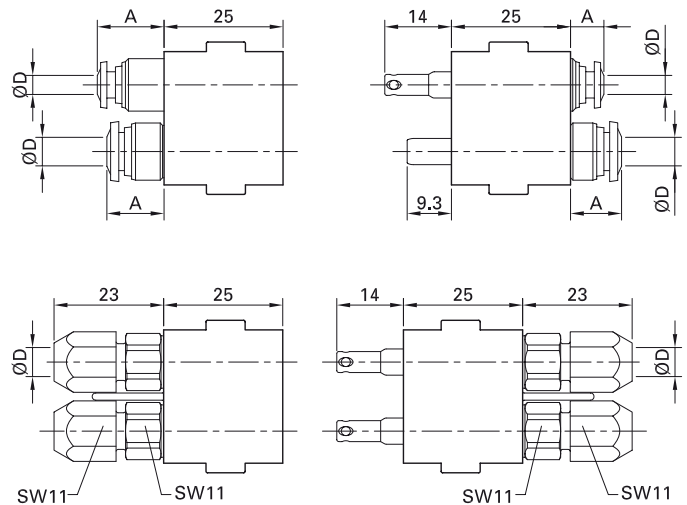

| Order No. | Type | Socket | Plug | Outer-Ø D of the tube | | A | Shut-off | | Press ring color |
|-----------|-----------------------------|--------|------|-----------------------|--------|------|----------|------|------------------|
| | | | | mm | " | | Without | With | |
| 33.0180 | CT-B-RCT03/4 | x | | 4 | (5/32) | 14 | x | | ● |
| 33.0181 | CT-BV-RCT03/4 | x | | 4 | (5/32) | 14 | | x | ● |
| 33.0580 | CT-S-RCT03/4 | | x | 4 | (5/32) | 7 | x | | ● |
| 33.0182 | CT-B-RCT03/6 ¹⁾ | x | | 6 | | 17 | x | | ● |
| 33.0183 | CT-BV-RCT03/6 ¹⁾ | x | | 6 | | 17 | | x | ● |
| 33.0582 | CT-S-RCT03/6 ¹⁾ | | x | 6 | | 11.5 | x | | ● |
| 33.0184 | CT-B-RCT03/1/4" | x | | | 1/4 | 17 | x | | ● |
| 33.0185 | CT-BV-RCT03/1/4" | x | | | 1/4 | 17 | | x | ● |
| 33.0584 | CT-S-RCT03/1/4" | | x | | 1/4 | 11.5 | x | | ● |
| 33.0175 | CT-B-RCT03/PLV4/6 | x | | 6 | | | x | | |
| 33.0179 | CT-BV-RCT03/PLV4/6 | x | | 6 | | | | x | |
| 33.0578 | CT-S-RCT03/PLV4/6 | | x | 6 | | | x | | |
| 33.0275 | CT-B-RCT03/PLV 2/4 | x | | 4 | | | x | | |
| 33.0279 | CT-BV-RCT03/PLV 2/4 | x | | 4 | | | | x | |
| 33.0675 | CT-S-RCT03/PLV 2/4 | | x | 4 | | | x | | |
| 33.0186 | CT-B-UCT04/6 ¹⁾ | x | | 6 | | 12 | x | | ● |
| 33.0586 | CT-S-UCT04/6 ¹⁾ | | x | 6 | | 10.7 | x | | ● |
| 33.0188 | CT-B-UCT04/1/4" | x | | | 1/4 | 12 | x | | ● |
| 33.0588 | CT-S-UCT04/1/4" | | x | | 1/4 | 10.7 | x | | ● |

¹⁾ For flow, head loss diagrams, and sliding forces, see page 109.

²⁾ Lubrication interval every 20,000 mating cycles, see MA213.

Carriers for compressed air couplings CT-E-UCT06-...

1-, 2-, or 4-pole carrier made of resilient plastic.

Note:

The contact carrier can be used on both the socket and the pin side. The difference shows in the position of the MC logo.

CT-E-UCT06-1



Socket side

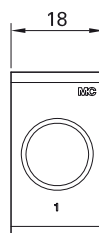

Pin side



CT-E-UCT06-2



Socket side

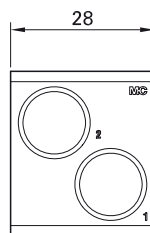

Pin side

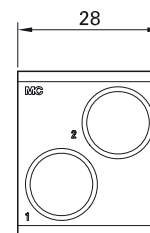

CT-E-UCT06-4



Socket side

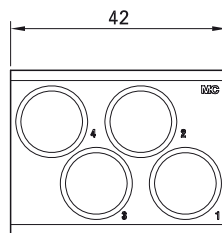

Pin side

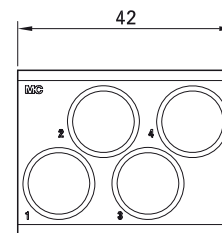

| Order No. | Type | Number of poles | For sockets | For plugs |
|-----------|--------------|-----------------|-------------|-----------|
| 33.4028 | CT-E-UCT06-1 | 1 | x | x |
| 33.4029 | CT-E-UCT06-2 | 2 | x | x |
| 33.4030 | CT-E-UCT06-4 | 4 | x | x |

Technical data

Contact carrier material | EPTR

Compressed air couplings CT-...-UCT06/8

For carriers CT-E-UCT06-...

Type of termination:

Clamping termination for calibrated plastic tubes (PA or PU)

CT-B-UCT06/8



CT-S-UCT06/8

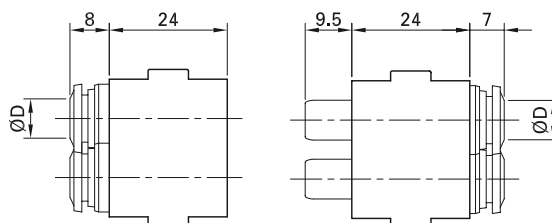

| Order No. | Type | Socket | Plug | Outer-Ø D of the tube | | Shut-off | | Press ring color |
|-----------|----------------------------|--------|------|-----------------------|--------|----------|------|------------------|
| | | | | mm | " | Without | With | |
| 33.0190 | CT-B-UCT06/8 ¹⁾ | x | | 8 | (5/16) | x | | |
| 33.0590 | CT-S-UCT06/8 ¹⁾ | | x | 8 | (5/16) | x | | |

Technical data

| | |
|------------------------------|-----------------------|
| Nominal bore (mm) | 06 |
| Max. working pressure (bar) | 15 |
| Min. working pressure (mbar) | 14 |
| Operating temperatures | -15 °C ... +90 °C |
| Sealing materials | NBR |
| Mating cycles | 100,000 ²⁾ |

¹⁾ For flow, head loss diagrams, and sliding forces, see page 110.

²⁾ Lubrication interval every 20,000 mating cycles, see MA213.

Carriers for compressed air couplings CT-E-UCT08-...

1- or 2-pole contact carrier made of resilient plastic.

Note:

The contact carrier can be used on both the socket and the pin side. The difference can be seen in the position of the MC logo.

CT-E-UCT08-1



Socket side

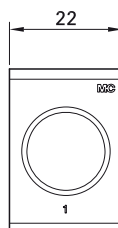

Pin side

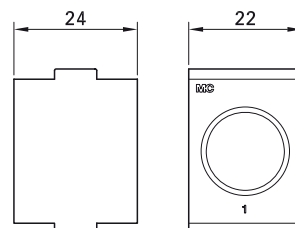

CT-E-UCT08-2



Socket side

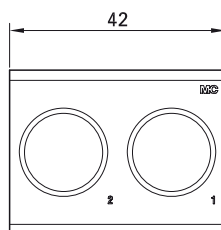

Pin side

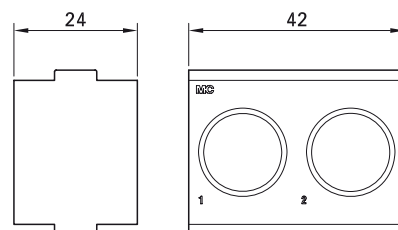

| Order No. | Type | Number of poles | For sockets | For plugs |
|-----------|--------------|-----------------|-------------|-----------|
| 33.4032 | CT-E-UCT08-1 | 1 | x | x |
| 33.4031 | CT-E-UCT08-2 | 2 | x | x |

Technical data

| | |
|--------------------------|------|
| Contact carrier material | EPTR |
|--------------------------|------|

Technical data from page 63:

Technical data

| | RCT06 | UCT08 |
|------------------------------|-----------------------|-------|
| Nominal bore (mm) | 06 | 08 |
| Max. working pressure (bar) | 15 | |
| Min. working pressure (mbar) | 14 | |
| Operating temperatures | -15 °C ... +90 °C | |
| Sealing materials | NBR | |
| Mating cycles | 100,000 ¹⁾ | |

¹⁾ Lubrication interval every 20,000 mating cycles, see MA213.

Compressed air couplings CT-...-UCT08... and CT-...-RCT06/...

For carriers CT-E-UCT08-...

Type of termination:
Clamping and PLV screw termination for
calibrated plastic tubes (PA or PU)

CT-BV-RCT06/8



CT-S-RCT06/8

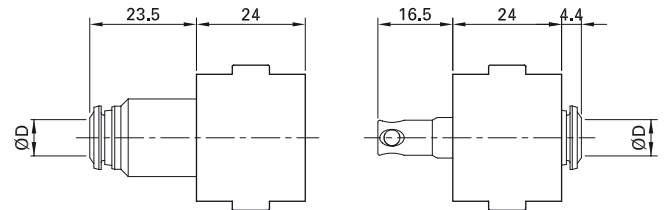

CT-B-UCT08/10



CT-S-UCT08/10

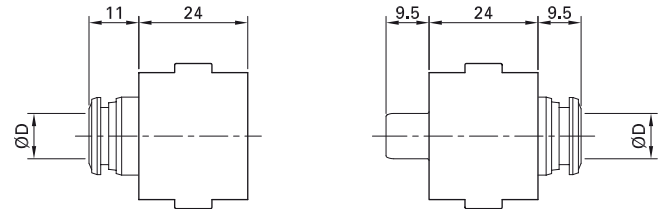

CT-BV-RCT06/PLV6/8



CT-S-RCT06/PLV6/8

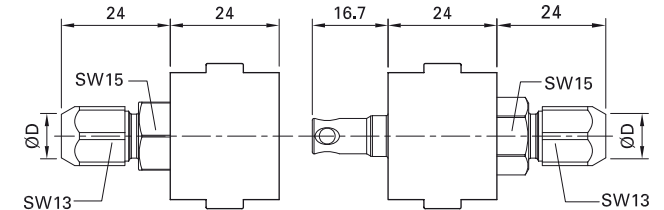

CT-BV-RCT06/PLV8/10



CT-S-RCT06/PLV8/10

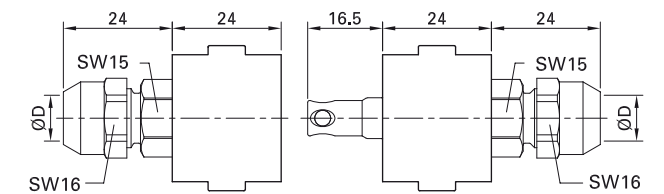

| Order No. | Type | Socket | Plug | Outer-Ø D of the tube | | A | Shut-off | | Press ring color |
|-----------|-----------------------------|--------|------|-----------------------|--------|---|----------|------|------------------|
| | | | | mm | " | | without | with | |
| 33.0201 | CT-BV-RCT06/8 | x | | 8 | (5/16) | | ← | ⊙ | ● |
| 33.0601 | CT-S-RCT06/8 | | x | 8 | (5/16) | | x | | ● |
| 33.0176 | CT-BV-RCT06/PLV6/8 | x | | 8 | | | | x | |
| 33.0576 | CT-S-RCT06/PLV6/8 | | x | 8 | | | x | | |
| 33.0177 | CT-BV-RCT06/PLV8/10 | x | | 10 | | | | x | |
| 33.0577 | CT-S-RCT06/PLV8/10 | | x | 10 | | | x | | |
| 33.0194 | CT-B-UCT08/10 ¹⁾ | x | | 10 | | | x | | ● |
| 33.0594 | CT-S-UCT08/10 ¹⁾ | | x | 10 | | | x | | ● |
| 33.0196 | CT-B-UCT08/3/8" | x | | | 3/8 | | x | | ● |
| 33.0596 | CT-S-UCT08/3/8" | | x | | 3/8 | | x | | ● |

¹⁾ For flow, head loss diagrams, and sliding forces, see page 110.

Carriers for coolants couplings CT-E8...

2- and 4-pole carrier made of resilient plastic.

CT-E8-2

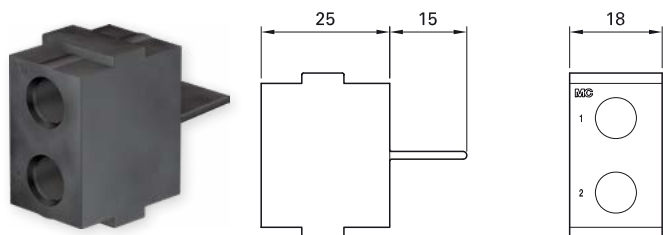

CT-E8-4/B

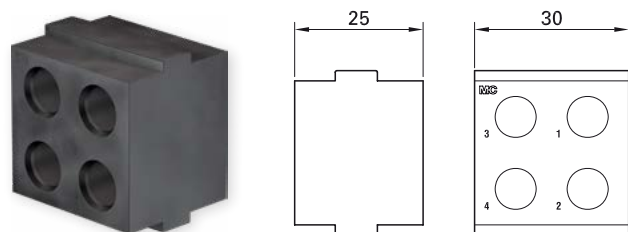

CT-E8-4/S

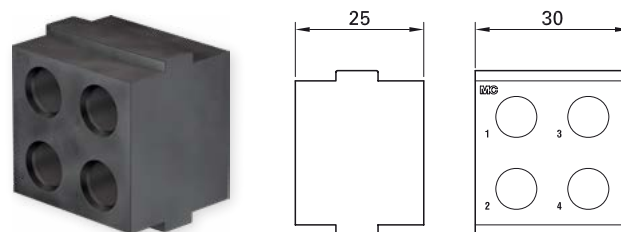

| Order No. | Type | Number of poles | For sockets | For plugs |
|-----------|-----------|-----------------|-------------|-----------|
| 33.4000 | CT-E8-2 | 2 | × | × |
| 33.4024 | CT-E8-4/B | 4 | × | |
| 33.4027 | CT-E8-4/S | 4 | | × |

Technical data

| | |
|--------------------------|------|
| Contact carrier material | EPTR |
|--------------------------|------|

Coolants couplings CT-...-SCT03

For carriers CT-E8..., leakproof, shut-off on both sides

Type of termination:
Internal thread

CT-B-SCT03



CT-S-SCT03

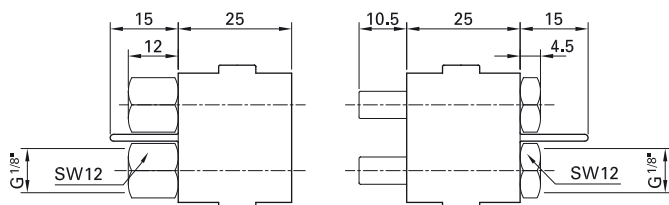

| Order No. | Type | Socket | Plug | Outer-Ø D of the tube | Shut-off | |
|----------------|--------------------------|--------|------|-----------------------|-----------|--|
| | | | | | Leakproof | |
| | | | | " | | |
| 33.0198 | CT-B-SCT03 ¹⁾ | x | | G 1/8 | x | |
| 33.0598 | CT-S-SCT03 ¹⁾ | | x | G 1/8 | x | |

| Technical data | |
|------------------------------|-----------------------|
| Nominal bore (mm) | 03 |
| Max. working pressure (bar) | 15 |
| Min. working pressure (mbar) | 14 |
| Insertion force | 43 N / 0 bar |
| Operating temperatures | -15 °C ... +90 °C |
| Sealing materials | NBR |
| Mating cycles | 100,000 ²⁾ |

¹⁾ For flow, head loss diagrams, and sliding forces, see page 111.

²⁾ Lubrication interval every 20,000 mating cycles, see MA213.

Carriers for coolants couplings CT-E-UCT08-...

1- and 2-pole carriers made of resilient plastic.

Note:

The contact carrier can be used on both the socket and the pin side. The difference can be seen in the position of the MC logo.

CT-E-UCT08-1



Socket side

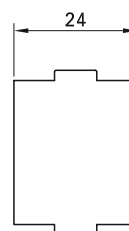
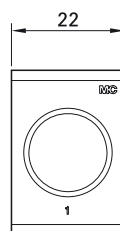

Pin side

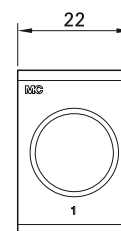

CT-E-UCT08-2



Socket side

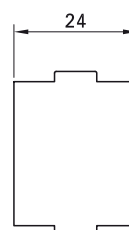
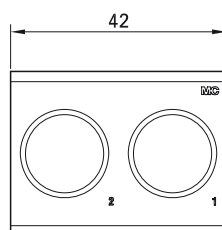

Pin side

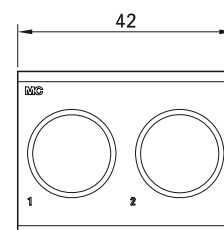

| Order No. | Type | Number of poles | For sockets | For plugs |
|-----------|--------------|-----------------|-------------|-----------|
| 33.4032 | CT-E-UCT08-1 | 1 | × | × |
| 33.4031 | CT-E-UCT08-2 | 2 | × | × |

Technical data

| | |
|--------------------------|------|
| Contact carrier material | EPTR |
|--------------------------|------|

Coolants couplings CT-...-SCT05

For carrier CT-E-UCT08-..., leakproof, shut-off on both sides

Type of termination:

Internal thread

Note:

Not suited for use in DIN housings. Due to the long stroke of the SCT05 coupling, two movements (push and lock) are required to connect the DIN housing.

CT-B-SCT05



CT-S-SCT05

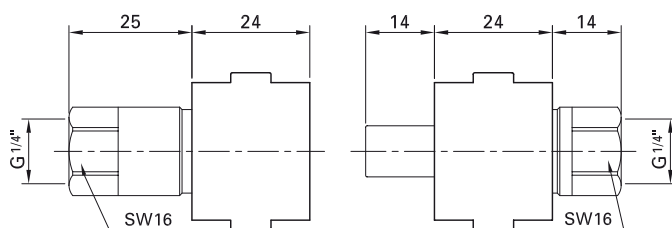

| Order No. | Type | Socket | Plug | Outer-Ø D of the tube | | A | Shut-off |
|-----------|--------------------------|--------|------|-----------------------|-------|---|----------|
| | | | | mm | " | | With |
| 33.0199 | CT-B-SCT05 ¹⁾ | x | | 8 | (1/4) | | x |
| 33.0599 | CT-S-SCT05 ¹⁾ | | x | 8 | (1/4) | | x |

| Technical data | |
|------------------------------|-----------------------|
| Nominal bore (mm) | 05 |
| Max. working pressure (bar) | 15 |
| Min. working pressure (mbar) | 14 |
| Insertion force | 60 N / 0 bar |
| Operating temperatures | -15 °C ... +90 °C |
| Sealing materials | NBR |
| Mating cycles | 100,000 ²⁾ |

Note

Observe page 114 :
Electrical plug connectors for control and power in the immediate proximity of connections for liquids and gas.

¹⁾ For flow, head loss diagrams, and sliding forces, see page 111.

²⁾ Lubrication interval every 20,000 mating cycles, see MA213..

SINGLE PARTS FOR COMBITAC FRAMES

Single parts for CombiTac frames

Note:

Supporting rails are available in lengths from 18 mm up to 180 mm in steps of 2 mm (18, 20, 22, 24, etc.).

Exception: For housing size 2, a length of 43 mm is required. The length must be stated in mm together with the order No.
Mating cycles of end pieces: > 100,000
The end pieces are designed solely for the

guiding of the connectors and the associated forces.

In a permanent installation application, the customer must provide a stable guide system, e.g. with mechanical pins.



| Order No. | Type | Designation | Number per frame | | |
|--------------------|----------------------|--|------------------|-----|--|
| | | | Socket | Pin | |
| 33.5606-... | CT-BS | Supporting rail in plastic (PA) (length in mm) | 2 | 2 | |
| 33.5601-... | CT-BS | Supporting rail in aluminum, on request (length in mm) | 2 | 2 | |
| 33.4056 33.5618 | CT-BEG-B CT-BTG-B | Standard end piece for DIN housing, sockets Option without earth connection | 2 | | |
| 33.4057 33.5619 | CT-BEG-S CT-BTG-S | Standard end piece for DIN housing, pins Option without earth connection | | 2 | |
| 33.4054 33.4058 | CT-BE-B CT-BESZ-B | Standard end piece for panel mounting, sockets Option with earth connection | 2 | | |
| 33.4055 33.4059 | CT-BE-S CT-BESZ-S | Standard end piece for panel mounting, pins Option with earth connection | | 2 | |
| 33.5615 | LI-BL-SHR | Filister head screw (for securing the end pieces) | 8 | 8 | |
| 33.5623 | LI-KM-SHR | Combi screw (for securing in the DIN housing) | 4 | 4 | |

CALCULATION OF INSTALLATION DIMENSIONS

Calculation of installation dimensions

To determine the dimension L, the width of all contact carriers in the relevant configuration must be taken into account.

Note:

- If necessary, fill up with spacers (see page 78)

- General dimensional tolerances ± 0.1 mm
- L1 (recess dimensions) = L + 22 mm; L2 = L + 33 mm

| Type | Number | Width | |
|--------------------------------|--------|------------|---|
| CT-E8-2 | | x 18 mm | = |
| CT-E8/6-1 | | x 16 mm | = |
| CT-E8/6-PE | | x 16 mm | = |
| CT-E6-2 | | x 16 mm | = |
| CT-E3-3 | | x 10 mm | = |
| CT-E3/PCB | | x 10 mm | = |
| CT-E3-2+PE | | x 10 mm | = |
| CT-E1,5-5 | | x 6 mm | = |
| CT-E1-26/B, CT-E1-26/S | | x 18 mm | = |
| CT-E1-15/B, CT-E1-15/S | | x 20 mm | = |
| CT-E1-6 | | x 4 mm | = |
| CT-E-3POF/B, CT-E-3POF/S | | x 6 mm | = |
| CT-E-2TH+PE/B, CT-E-2TH+PE/S | | x 6 mm | = |
| CT-E8-4/B, CT-E8-4/S | | x 30 mm | = |
| CT-E-UCT06-1 | | x 18 mm | = |
| CT-E-UCT06-2 | | x 28 mm | = |
| CT-E-UCT06-4 | | x 42 mm | = |
| CT-E-UCT08-1 | | x 22 mm | = |
| CT-E-UCT08-2 | | x 42 mm | = |
| further moduls | | | |
| Contact carriers | | | |
| CT-DIP1 | | x 1 mm | = |
| CT-DIP2 | | x 2 mm | = |
| CT-DIP3 | | x 3 mm | = |
| CT-DIP4 | | x 4 mm | = |
| further moduls | | | |
| Spacers | | | |
| Sum of the widths (min. 18 mm) | | L = | |

Socket side

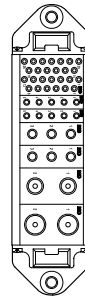

Pin side

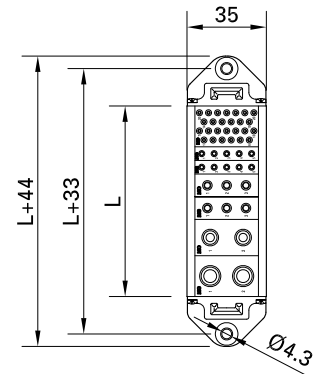

Socket side

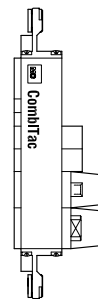

Pin side

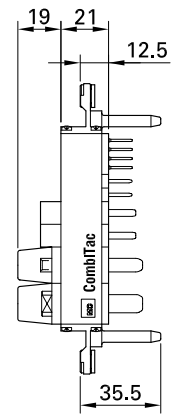

Drilling plan

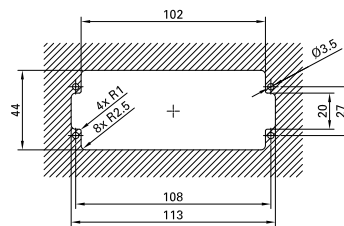
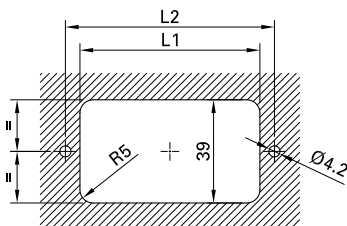

PANEL MOUNTED

Panel mounted

1. Max. permissible mounting offset

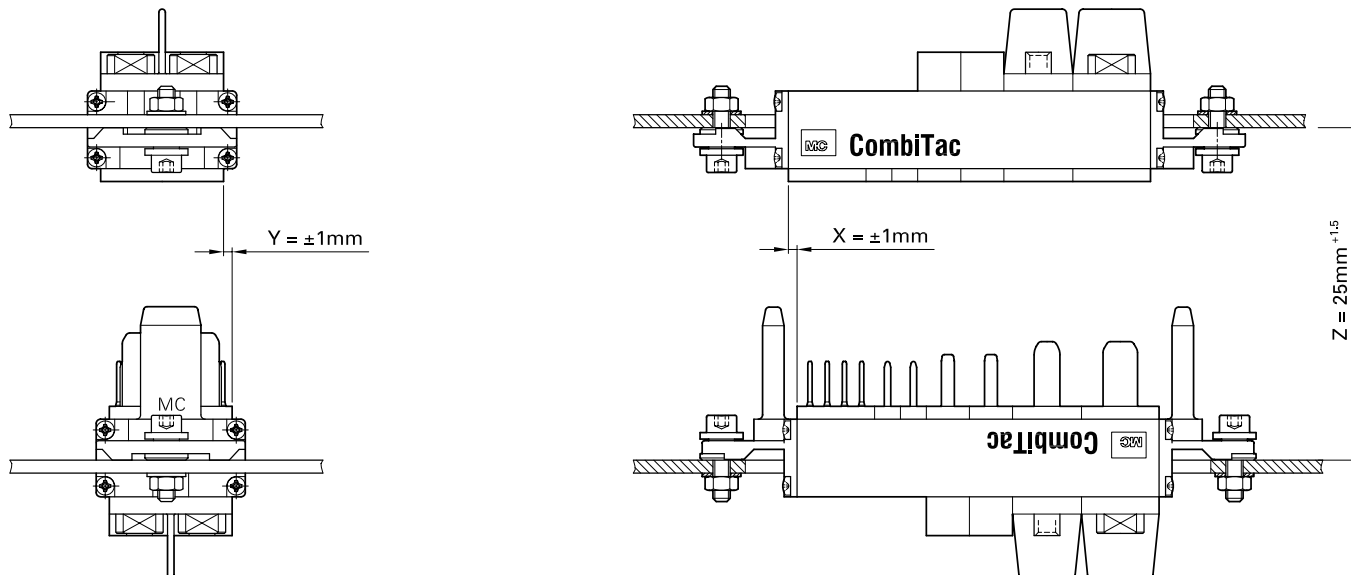

Distance Z in mated condition

2. Max. permissible mounting angular misalignment during mating

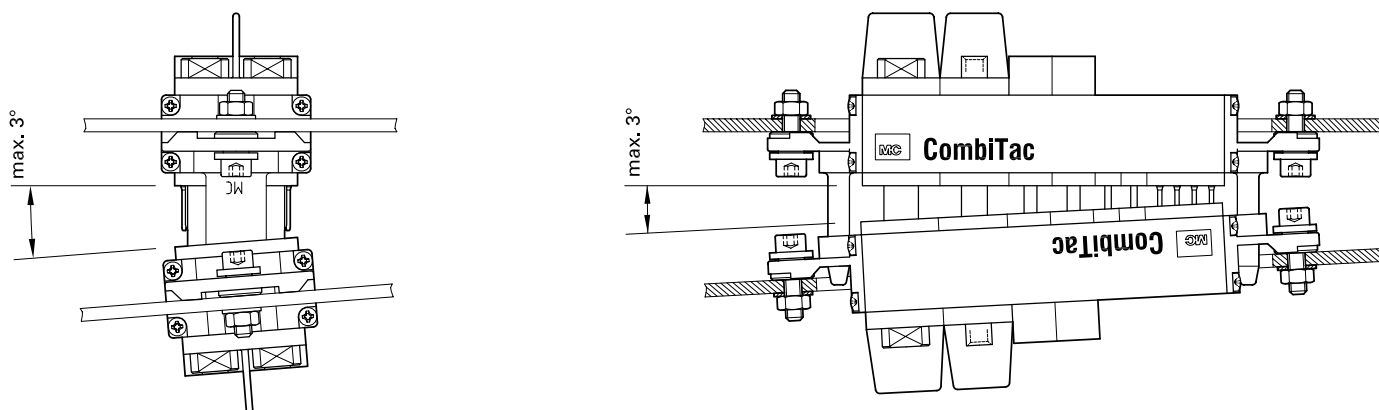

3. Max. permissible distance between the contact carriers when mated

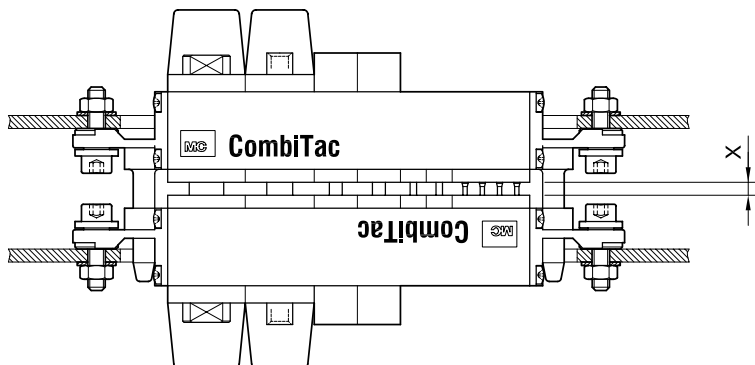
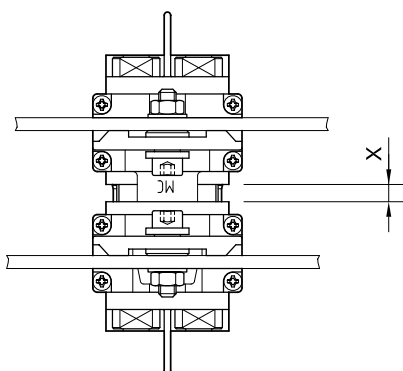

| Contacts | Sizes X |
|--------------------------------|---------|
| | max. mm |
| CT0.6 | 1.5 |
| Further electricals | 3 |
| POF crimp version | 1.5 |
| POF/SL Lens contact | 7.5 |
| Coaxial | 1.5 |
| Thermocouple pressure contacts | 1.5 |
| CT-NET | 2 |
| SCT | 2 |
| UCT/RCT | 2 |
| CT-E8-2-IP2X | 2 |
| CT-LMFB | 1 |

Plug connections with uncontrolled coupling force and undefined end position

Uncontrolled coupling forces may not be applied to the plug connectors, frames, and/or guide pins. In cases where these forces exist, the customer must utilize guide pins to protect the connection.

Failure to observe these recommendations can result in damage to the plug connection.

DIN HOUSINGS FOR COMBITAC

DIN housings for CombiTac

Connectors used in harsh environments must be protected by the use of a suitable housing.

Surface mount housing with protective cover

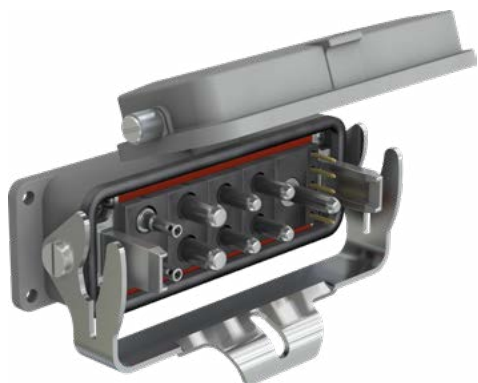

Coupler hood



Stäubli recommends the use of aluminum or plastic housings.



Aluminum DIN housing – robust IP65 housing designed for a variety of applications.



Plastic housing (thermoplast) – particularly suited for use in environments where housing will be exposed to corrosive elements.



6 different sizes

The **housing sizes 5 and 6** fit 2 CombiTac units.

6 different sizes



Housing sizes 5 and 6



2 different heights

The **surface mounting housing** is available with or without a protective cover. When closed, the lid protects all contacts from external influences (pollution, etc.).

The surface mount housing is also available with a protective lid. This option is available for all surface and pedestal mount housings or coupler hoods with plug end pieces.



With protective cover

Without protective cover

With protective cap



The **coupler hood with protective wall** provides IP2X finger protection during the plugging / unplugging operation in accordance with IEC 61984:2001 (DIN VDE 0627).

The protective wall can be used on only one side of the plug connection, preferably on the flying side (coupler hood).

Protective wall material PA.

With protective wall



The **pedestal mount housing** has two cable entry "A" ¹⁾ possibilities. The unused cable outlet is closed with the included blind plug.



The **coupler hood** is available with straight or lateral cable entry ¹⁾.

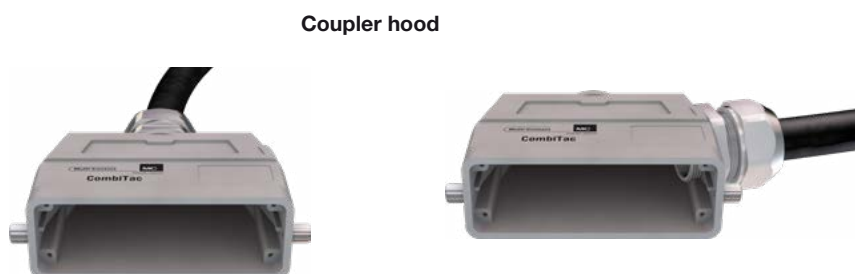

To protect unmated CombiTac, Stäubli recommends the use of **park stations** (surface mount housings with end pieces).



¹⁾ Cable gland is not included.
 Recommended producers:
 AGRO www.agro.ch
 LAPP KABEL www.lapp.de
 PFLITSCH www.pflitsch.de
 HUMMEL www.hummel-group.com

Restrictions concerning the DIN surface mount housing with protective cover

If the max. pin length (see table) is exceeded, or if a DIN surface mount housing is fitted in

combination with end pieces for plugs, the protective cover cannot be closed.



End pieces

| Housing size | Pin length |
|--------------|------------|
| | max. mm |
| 1 | 14 |
| 2 | 17 |
| 3 | 17 |
| 4 | 17 |
| 5 | 12 |
| 6 | 16.5 |

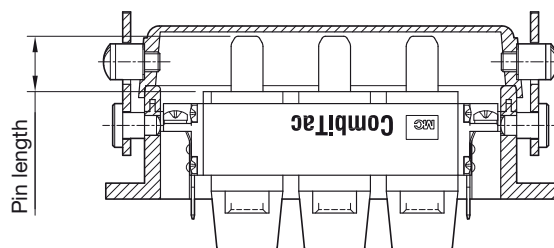

Earthing over end pieces

End pieces with contact spring and flat plug connection (6.3×0.8 mm) permits connection between the two housings and earth (ground).

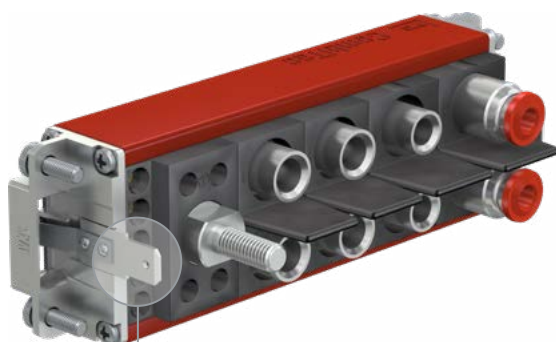

End pieces with contact spring and flat plug connection

Coding

CombiTac in housings can be coded by fitting coding pins in place of the fixing screws. A total of 6 coding variants are possible.

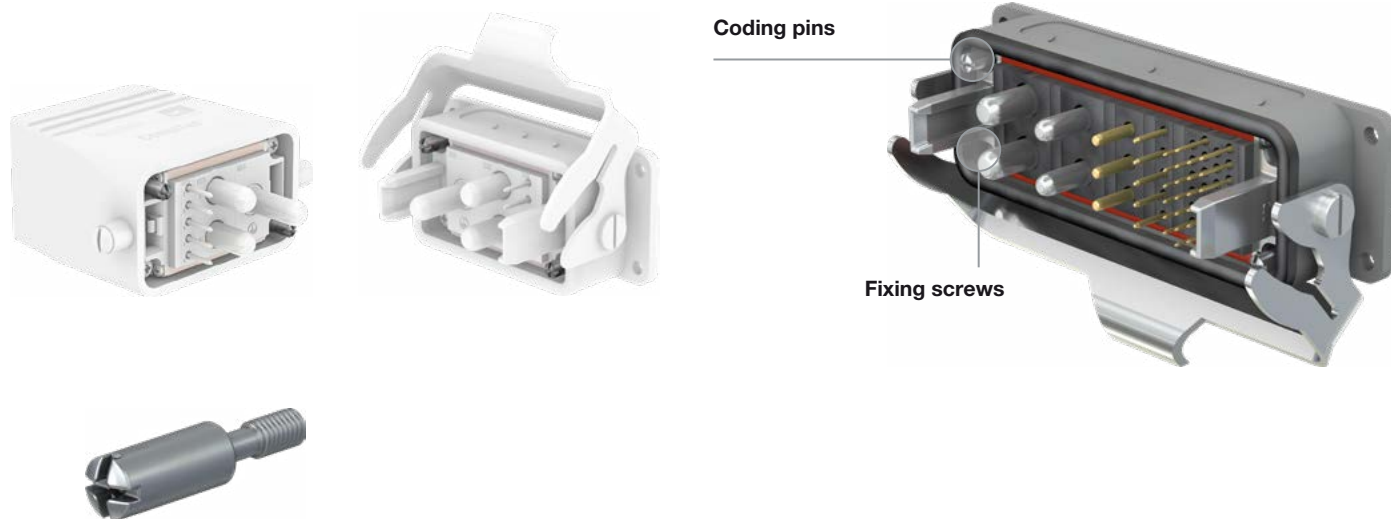

| Order No. | Type |
|-----------|-------|
| 33.1021 | CT-CN |

Coding variants

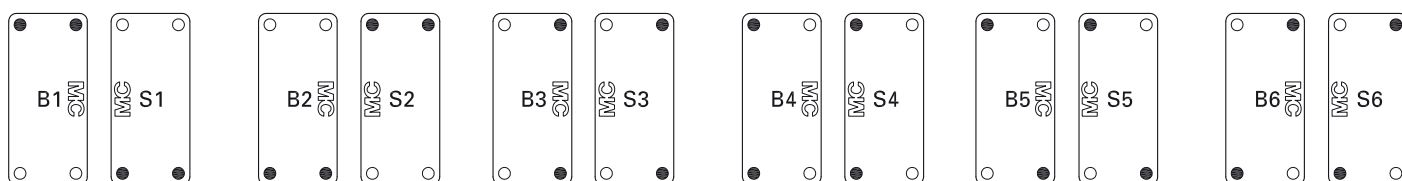

- S = Pin side
- B = Socket side
- = Coding pin CT-CN

Note:
If the contacts are arranged symmetrically, a pole reversal is possible with the following codings: S5/B5, S6/B6, S1/B2, S2/B1, S3/B4, S4/B3, S5/B6, S6/B5. Coding can ne-

vertheless be achieved by means of spacers, see page 78.
If modules of type CT-12 or CT-0.6 are included, no coding is necessary (asymmetrical configuration).

Calculation of housing size

Note:

Minimum length L = 30 mm. The maximum length L of the relevant housing size must be reached. If necessary, fill up with spacers (see page 78).

| Type | Number | Width | |
|--------------------------------|----------------|----------|---|
| CT-E8-2 | | x 18 mm | = |
| CT-E8/6-1 | | x 16 mm | = |
| CT-E8/6-PE | | x 16 mm | = |
| CT-E6-2 | | x 16 mm | = |
| CT-E3-3 | | x 10 mm | = |
| CT-E3/PCB | | x 10 mm | = |
| CT-E3-2+PE | | x 10 mm | = |
| CT-E1,5-5 | | x 6 mm | = |
| CT-E1-26/B, CT-E1-26/S | | x 18 mm | = |
| CT-E1-15/B, CT-E1-15/S | | x 20 mm | = |
| CT-E1-6 | | x 4 mm | = |
| CT-E-3POF/B, CT-E-3POF/S | | x 6 mm | = |
| CT-E-2TH+PE/B, CT-E-2TH+PE/S | | x 6 mm | = |
| CT-E8-4/B, CT-E8-4/S | | x 30 mm | = |
| CT-E-UCT06-1 | | x 18 mm | = |
| CT-E-UCT06-2 | | x 28 mm | = |
| CT-E-UCT06-4 | | x 42 mm | = |
| CT-E-UCT08-1 | | x 22 mm | = |
| CT-E-UCT08-2 | | x 42 mm | = |
| further moduls | | | |
| Sum of the widths (min. 30 mm) | | L | = |
| Housing size | | | |
| Spacers | CT-DIP1 | x 1 mm | = |
| | CT-DIP2 | x 2 mm | = |
| | CT-DIP3 | x 3 mm | = |
| | CT-DIP4 | x 4 mm | = |
| | further moduls | | |
| Maximum length housing size | | | = |

| Size L (mm) | Housing size |
|----------------------------|--------------|
| 18 ≥ L ≤ 30 | 1 |
| 31 ≥ L ≤ 43 | 2 |
| 44 ≥ L ≤ 64 | 3 |
| 65 ≥ L ≤ 90 | 4 |
| 44 ≥ L ≤ 64 44 ≥ L ≤ 64 | 5 |
| 65 ≥ L ≤ 90 65 ≥ L ≤ 90 | 6 |

↑
Maximum length L

Example

| Type | Number | Width | Total | | |
|---------------|--------|---------|-------------|--------------|---|
| CT-E1-26/S... | 3 | x 18 mm | = 54 | | |
| CT-E3-3 | 3 | x 10 mm | = 30 | | |
| | | L | = 84 | Housing size | 4 |

Fill with spacers until max. housing dimension for housing size is reached:

| | | | | | |
|---------|---|--------|-------------|--|--|
| CT-DIP4 | 1 | x 4 mm | = 4 | | |
| CT-DIP2 | 1 | x 2 mm | = 2 | | |
| | | Result | = 90 | | |

Spacers

To fill gaps in the CombiTac or for connection coding.

CT-DIP4

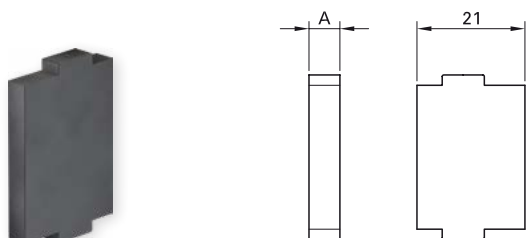

CT-DIP4/2

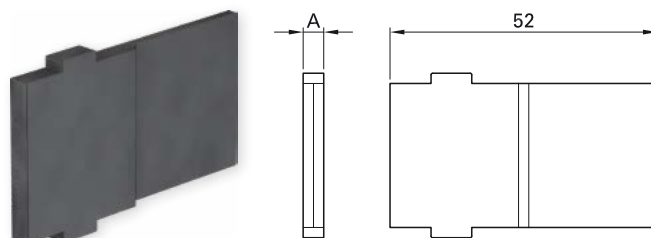

| Order No. | Type | Size A |
|-----------|-----------|--------|
| 33.4097 | CT-DIP0,5 | 0.5 mm |
| 33.4043 | CT-DIP1 | 1 mm |
| 33.4040 | CT-DIP2 | 2 mm |
| 33.4041 | CT-DIP3 | 3 mm |
| 33.4042 | CT-DIP4 | 4 mm |
| 33.4085 | CT-DIP4/2 | 4 mm |

Technical data

Contact carrier material | EPTR

Gaps filled with **spacers** in a CombiTac mounted in a DIN housing (pictures above). If the contacts are arranged symmetrically,

the possibility of pole reversal exists. With the help of spacers, a **connection coding** can be realized (pictures below).

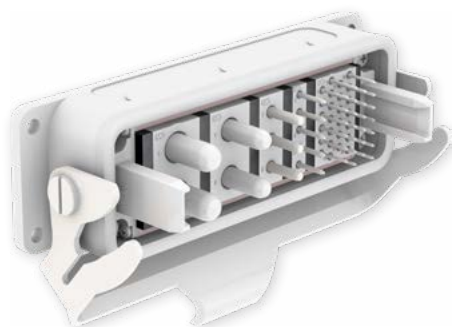

Spacers

Connection coding

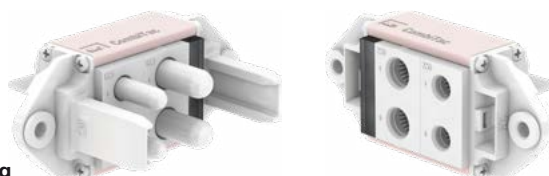

Aluminum DIN housings

Aluminum DIN housings with IP65 and IP68/
IP69K protection.



Technical data

| | |
|-------------------------------------|------------------------------|
| Housing material | Al die-cast (RAL 7037, gray) |
| Housing seal | NBR (-40 °C...+125 °C) |
| Locking element | Steel, zinc plated |
| Degree of protection mated / locked | IP65 IP68/IP69K (Page 85) |

Coupler hood

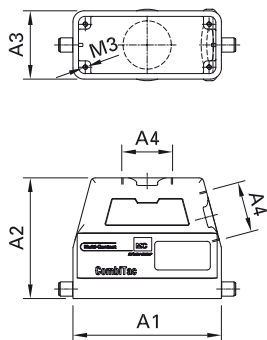

| Size | Order No. | Type | Cable entry | | Sizes (mm) | | | |
|------|-----------|----------|-------------|----------|------------|----|------|-----|
| | | | lateral | straight | A1 | A2 | A3 | A4 |
| 1 | 33.1551 | CT-TG1-S | × | | 60 | 72 | 43 | M32 |
| | 33.1571 | CT-TG1-G | | × | | | | |
| 2 | 33.1052 | CT-TG2-S | × | | 73 | 70 | 43 | M32 |
| | 33.1072 | CT-TG2-G | | × | | | | |
| 3 | 33.1053 | CT-TG3-S | × | | 93.5 | 76 | 43 | M32 |
| | 33.1073 | CT-TG3-G | | × | | | | |
| 4 | 33.1054 | CT-TG4-S | × | | 120 | 78 | 43 | M32 |
| | 33.1074 | CT-TG4-G | | × | | | | |
| 5 | 33.1055 | CT-TG5-S | × | | 95 | 79 | 82.5 | M40 |
| | 33.1075 | CT-TG5-G | | × | | | | |
| 6 | 33.1056 | CT-TG6-S | × | | 131 | 96 | 89 | M50 |
| | 33.1076 | CT-TG6-G | | × | | | | |

Coupler housing

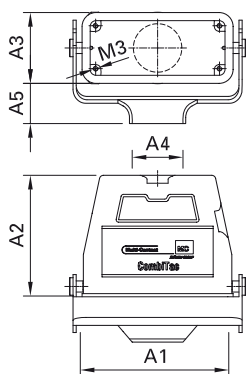

| Size | Order No. | Type | Cable entry | Sizes (mm) | | | | |
|------|-----------|--------|-------------|------------|------|------|-----|----|
| | | | straight | A1 | A2 | A3 | A4 | A5 |
| 1 | 33.1501 | CT-KG1 | × | 60 | 75 | 43 | M32 | 20 |
| 2 | 33.6002 | CT-KG2 | × | 73 | 74 | 43 | M32 | 35 |
| 3 | 33.6003 | CT-KG3 | × | 93.5 | 80 | 43 | M32 | 35 |
| 4 | 33.6004 | CT-KG4 | × | 120 | 82 | 43 | M32 | 35 |
| 5 | 33.6005 | CT-KG5 | × | 95 | 82.5 | 82.5 | M40 | 33 |

Coupler hood with protection wall, IP2X

CT-TG.../PW

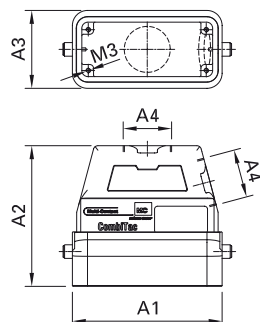

CT-TG.../PW-D

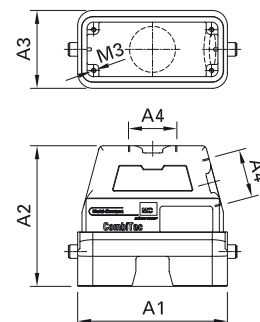

| Size | Order No. | Type | Cable entry | | suitable for | Sizes (mm) | | | |
|------|-----------|---------------|-------------|----------|--------------------|------------|------|------|-----|
| | | | lateral | straight | | A1 | A2 | A3 | A4 |
| 2 | 33.2052 | CT-TG2-S/PW | × | | | 78.5 | 87 | 51.5 | M32 |
| | 33.2072 | CT-TG2-G/PW | | × | | | | | |
| | 33.2092 | CT-TG2-S/PW-D | × | | CT-AG2-D (33.1092) | | | | |
| | 33.2122 | CT-TG2-G/PW-D | | × | CT-AG2-D (33.1092) | | | | |
| 3 | 33.2053 | CT-TG3-S/PW | × | | | 99 | 93 | 51.5 | M32 |
| | 33.2073 | CT-TG3-G/PW | | × | | | | | |
| | 33.2093 | CT-TG3-S/PW-D | × | | CT-AG3-D (33.1093) | | | | |
| | 33.2123 | CT-TG3-G/PW-D | | × | CT-AG3-D (33.1093) | | | | |
| 4 | 33.2054 | CT-TG4-S/PW | × | | | 125 | 96.5 | 51.5 | M32 |
| | 33.2074 | CT-TG4-G/PW | | × | | | | | |
| | 33.2094 | CT-TG4-S/PW-D | × | | CT-AG4-D (33.1094) | | | | |
| | 33.2124 | CT-TG4-G/PW-D | | × | CT-AG4-D (33.1094) | | | | |
| 5 | 33.2055 | CT-TG5-S/PW | × | | | 101 | 95.5 | 91 | M40 |
| | 33.2075 | CT-TG5-G/PW | | × | | | | | |
| | 33.2095 | CT-TG5-S/PW-D | × | | CT-AG5-D (33.1095) | | | | |
| | 33.2125 | CT-TG5-G/PW-D | | × | CT-AG5-D (33.1095) | | | | |
| 6 | 33.2056 | CT-TG6-S/PW | × | | | 136 | 121 | 98.5 | M50 |
| | 33.2076 | CT-TG6-G/PW | | × | | | | | |
| | 33.2096 | CT-TG6-S/PW-D | × | | CT-AG6-D (33.1096) | | | | |
| | 33.2126 | CT-TG6-G/PW-D | | × | CT-AG6-D (33.1096) | | | | |

Surface mount housing

CT-AG...

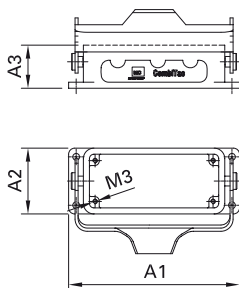

CT-AG...-D

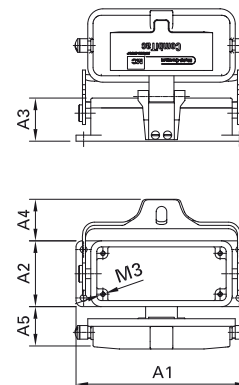

| Size | Order No. | Type | Protective cover | | Sizes (mm) | | | | |
|------|-----------|----------|------------------|------|------------|------|------|----|----|
| | | | without | with | A1 | A2 | A3 | A4 | A5 |
| 1 | 33.1561 | CT-AG1 | x | | 82 | 43 | 29 | 20 | - |
| | 33.1591 | CT-AG1-D | | x | | | | | |
| 2 | 33.1062 | CT-AG2 | x | | 93 | 43.5 | 28.5 | 35 | - |
| | 33.1092 | CT-AG2-D | | x | | | | | |
| 3 | 33.1063 | CT-AG3 | x | | 113 | 43.5 | 28.5 | 35 | - |
| | 33.1093 | CT-AG3-D | | x | | | | | |
| 4 | 33.1064 | CT-AG4 | x | | 140 | 43.5 | 28.5 | 35 | - |
| | 33.1094 | CT-AG4-D | | x | | | | | |
| 5 | 33.1065 | CT-AG5 | x | | 124 | 90 | 36 | 27 | - |
| | 33.1095 | CT-AG5-D | | x | | | | | |
| 6 | 33.1066 | CT-AG6 | x | | 165 | 90 | 38.5 | 50 | - |
| | 33.1096 | CT-AG6-D | | x | | | | | |

Surface mount housing with protection wall

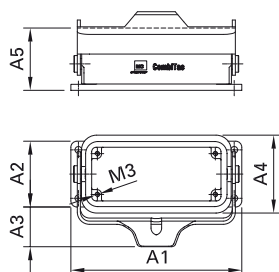

Note: IP2X

| Size | Order No. | Type | Sizes (mm) | | | | |
|------|-----------|-----------|------------|------|----|------|----|
| | | | A1 | A2 | A3 | A4 | A5 |
| 2 | 33.2062 | CT-AG2/PW | 93 | 43.5 | 35 | 51.5 | 41 |
| 3 | 33.2063 | CT-AG3/PW | 113 | 43.5 | 35 | 51.5 | 41 |
| 4 | 33.2064 | CT-AG4/PW | 140 | 43.5 | 35 | 51.5 | 41 |
| 5 | 33.2065 | CT-AG5/PW | 124 | 84 | 33 | 91 | 48 |

Pedestal mount housing

CT-SG...-H

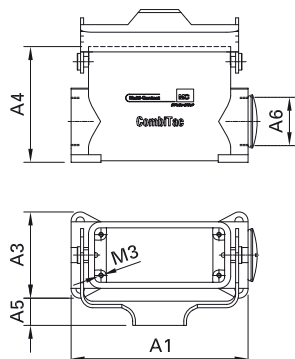

CT-SG...-H/D

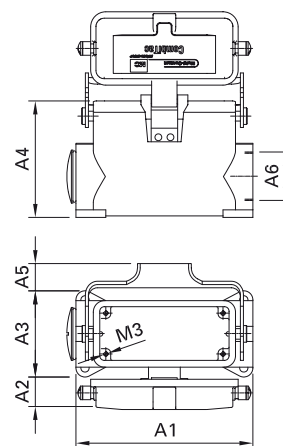

| Size | Order No. | Type | Protective cover | | Sizes (mm) | | | | | |
|------|-----------|------------|------------------|------|------------|----|------|------|------|-----|
| | | | without | with | A1 | A2 | A3 | A4 | A5 | A6 |
| 1 | 33.1541 | CT-SG1-H | x | | 82 | - | 54.5 | 74 | 13.5 | M32 |
| | 33.1581 | CT-SG1-H/D | | x | | 20 | | | | |
| 2 | 33.1042 | CT-SG2-H | x | | 94 | - | 57 | 74 | 30 | M32 |
| | 33.1082 | CT-SG2-H/D | | x | | 20 | | | | |
| 3 | 33.1043 | CT-SG3-H | x | | 117 | - | 57 | 77 | 29 | M32 |
| | 33.1083 | CT-SG3-H/D | | x | | 22 | | | | |
| 4 | 33.1044 | CT-SG4-H | x | | 144 | - | 57 | 78.5 | 30 | M32 |
| | 33.1084 | CT-SG4-H/D | | x | | 20 | | | | |
| 5 | 33.1045 | CT-SG5-H | x | | 126 | - | 84 | 78.5 | 33 | M32 |
| | 33.1085 | CT-SG5-H/D | | x | | 22 | | | | |
| 6 | 33.1046 | CT-SG6-H | x | | 140 | - | 120 | 98.5 | 37 | M40 |
| | 33.1086 | CT-SG6-H/D | | x | | 10 | | | | |

Pedestal mount housing with protection wall

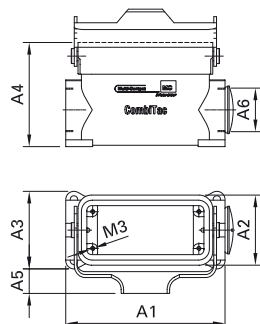

Note: IP2X

| Size | Order No. | Type | Sizes (mm) | | | | | |
|------|-----------|-------------|------------|------|----|----|-----|----|
| | | | A1 | A2 | A3 | A5 | A6 | A4 |
| 2 | 33.2082 | CT-SG2-H/PW | 94 | 51.5 | 57 | 30 | M32 | 87 |
| 3 | 33.2083 | CT-SG3-H/PW | 117 | 51.5 | 57 | 29 | M32 | 90 |
| 4 | 33.2084 | CT-SG4-H/PW | 144 | 51.5 | 57 | 30 | M32 | 91 |
| 5 | 33.2085 | CT-SG5-H/PW | 126 | 91 | 84 | 33 | M32 | 91 |

Park station

Park station with plug end pieces to fit coupler hood socket side (picture left).

Park station with socket end pieces to fit coupler hood pin side (picture right).

CT-AG...-PS/S

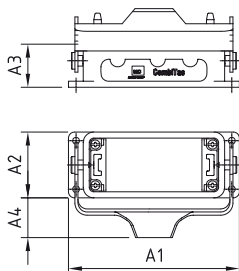

CT-AG...-PS/B

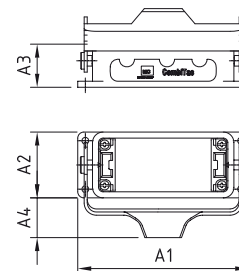

| Size | Order No. | Type | End pieces | | Sizes (mm) | | | |
|------|-----------|-------------|------------|-----|------------|------|------|----|
| | | | Socket | Pin | A1 | A2 | A3 | A4 |
| 1 | 34.0340 | CT-AG1-PS/S | | × | 82 | 43 | 29 | 21 |
| | 34.0341 | CT-AG1-PS/B | × | | | | | |
| 2 | 34.0342 | CT-AG2-PS/S | | × | 93 | 43.5 | 28.5 | 35 |
| | 34.0343 | CT-AG2-PS/B | × | | | | | |
| 3 | 34.0344 | CT-AG3-PS/S | | × | 113 | 43.5 | 28.5 | 35 |
| | 34.0345 | CT-AG3-PS/B | × | | | | | |
| 4 | 34.0346 | CT-AG4-PS/S | | × | 140 | 43.5 | 28.5 | 35 |
| | 34.0347 | CT-AG4-PS/B | × | | | | | |
| 5 | 34.0348 | CT-AG5-PS/S | | × | 124 | 84 | 36 | 33 |
| | 34.0349 | CT-AG5-PS/B | × | | | | | |
| 6 | 34.0350 | CT-AG6-PS/S | | × | 165 | 90 | 38.5 | 50 |
| | 34.0351 | CT-AG6-PS/B | × | | | | | |

Protective cap

For mounting on all surface and pedestal mountings or coupler hood with pin end pieces. Protective cap suitable for all pin lengths.

Protective cover material: PA.



| Size | Order No. | Type | for metal housing |
|------|-----------|------------------|-------------------|
| 1 | 33.1301 | CT-SD-AG1-L/FSCH | × |
| 2 | 33.1302 | CT-SD-AG2-L/FSCH | × |
| 3 | 33.1303 | CT-SD-AG3-L/FSCH | × |
| 4 | 33.1304 | CT-SD-AG4-L/FSCH | × |
| 5 | 33.1305 | CT-SD-AG5-L/FSCH | × |
| 6 | 33.1306 | CT-SD-AG6-L/FSCH | × |

Coupler hood with IP68/69K degree of protection

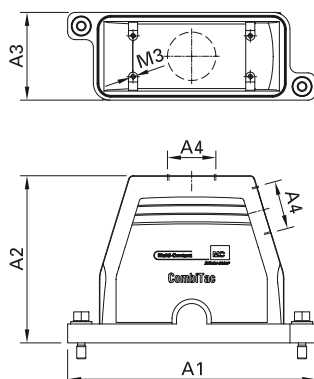

The all-round contact of the two housing halves of the IP68/69K enclosures provides a 360° shielding against electromagnetic influence according to VG 95373-41.

| Size | Order No. | Type | Cable entry | | Sizes (mm) | | | |
|------|-----------|------------------|-------------|----------|------------|-------|----|-----|
| | | | lateral | straight | A1 | A2 | A3 | A4 |
| 1 | 33.6871 | CT-TG1-S IP68 HE | × | | 132 | 100.5 | 58 | M32 |
| | 33.6881 | CT-TG1-G IP68 HE | | × | | | | |
| 2 | 33.6872 | CT-TG2-S IP68 HE | × | | 144 | 100.5 | 58 | M32 |
| | 33.6882 | CT-TG2-G IP68 HE | | × | | | | |
| 3 | 33.6873 | CT-TG3-S IP68 HE | × | | 164 | 110.5 | 58 | M40 |
| | 33.6883 | CT-TG3-G IP68 HE | | × | | | | |
| 4 | 33.6874 | CT-TG4-S IP68 HE | × | | 191 | 110.5 | 58 | M40 |
| | 33.6884 | CT-TG4-G IP68 HE | | × | | | | |

Surface mount housing with IP68/69K degree of protection

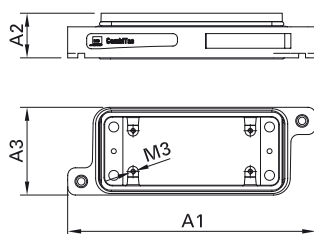

| Size | Order No. | Type | Sizes (mm) | | |
|------|-----------|----------------|------------|------|----|
| | | | A1 | A2 | A3 |
| 1 | 33.6851 | CT-AG1 IP68 HE | 132 | 29.5 | 58 |
| 2 | 33.6852 | CT-AG2 IP68 HE | 144 | 29.5 | 58 |
| 3 | 33.6853 | CT-AG3 IP68 HE | 164 | 29.5 | 58 |
| 4 | 33.6854 | CT-AG4 IP68 HE | 191 | 29.5 | 58 |

Pedestal mount housing with IP68 degree of protection

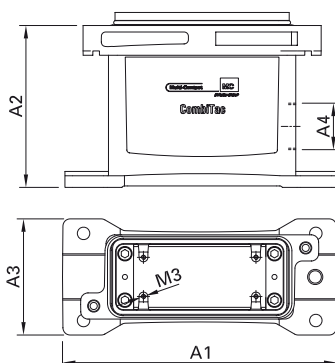

| Size | Order No. | Type | Sizes (mm) | | | |
|------|----------------|----------------|------------|-------|----|-------|
| | | | A1 | A2 | A3 | A4 |
| 1 | 33.6861 | CT-SG1 IP68 HE | 156 | 100.5 | 80 | 2×M25 |
| 2 | 33.6862 | CT-SG2 IP68 HE | 169 | 100.5 | 80 | 2×M32 |
| 3 | 33.6863 | CT-SG3 IP68 HE | 189 | 111.5 | 80 | 2×M32 |
| 4 | 33.6864 | CT-SG4 IP68 HE | 216 | 111.5 | 80 | 2×M40 |

Central locking IP65 (on request)

CT-TG.../ZV

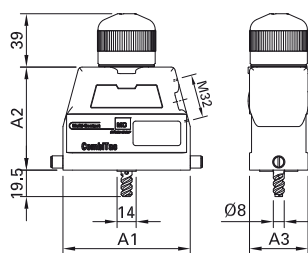

CT-AG.../ZV

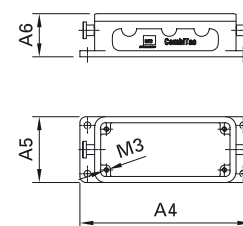

| Size | Order No. | Type | Designation | Sizes (mm) | | | | | |
|------|------------------|---------------|---|------------|----|----|-----|------|------|
| | | | | A1 | A2 | A3 | A4 | A5 | A6 |
| | 33.1418 | CT-ZV/B | Locking head complete | - | - | - | - | - | - |
| 2 | 33.4018-2 | CT-E-ZV/B/TG2 | Carrier with threaded spindle | - | - | - | - | - | - |
| 3 | 33.4018-3 | CT-E-ZV/B/TG3 | | - | - | - | - | - | - |
| 4 | 33.4018-4 | CT-E-ZV/B/TG4 | | - | - | - | - | - | - |
| | 33.4021 | CT-E-ZV/S | Thread carrier | - | - | - | - | - | - |
| 2 | 33.2032 | CT-TG2/ZV | Coupler hood for central locking | 73 | 70 | 43 | - | - | - |
| 3 | 33.2033 | CT-TG3/ZV | | 93.5 | 76 | 43 | - | - | - |
| 4 | 33.2034 | CT-TG4/ZV | | 120 | 78 | 43 | - | - | - |
| 2 | 33.1562 | CT-AG2/ZV | Surface mount housing for central locking | - | - | - | 93 | 43.5 | 28.5 |
| 3 | 33.1563 | CT-AG3/ZV | | - | - | - | 113 | 43.5 | 28.5 |
| 4 | 33.1564 | CT-AG4/ZV | | - | - | - | 140 | 43.5 | 28.5 |

Plastic DIN housing

The plastic housing is primarily intended for industrial use or for applications where a high resistance to chemical environmental influences is required.

In addition, the plastic housing is mechanically robust.

As the housing is made of antistatic thermoplastic material, there is no need for additional grounding.



Technical data

| | |
|-------------------------------------|---------------|
| Housing material | Thermoplastic |
| Housing seal | Elastomer |
| Locking element | Thermoplastic |
| Degree of protection mated / locked | IP65 |

| Plastic housing – Resistance to aggressive media | | |
|--|-----------|--------------------|
| | Resistant | Limited resistance |
| 1-Pentanol | | x |
| Alum | x | |
| Amide, aqueous | x | |
| Ammonia gas | | x |
| Ammonia, 10% aqueous solution | x | |
| Ammonium acetate | x | |
| Ammonium carbonate | x | |
| Ammonium chloride | x | |
| Ammonium nitrate | x | |
| Ammonium phosphate | x | |
| Ammonium sulfate | x | |
| Aniline | | x |
| Asphalt | | x |
| Beer | x | |
| Borated water | x | |
| Borax | | x |
| Boric acid, 10% aqueous solution | x | |
| Boric acid | x | |
| Butane gas | | x |
| Butane, liquid | | x |
| Calcium chloride, 10% aqueous solution | x | |
| Calcium chloride | x | |
| Calcium nitrate | x | |
| Calcium sulfate | x | |
| Chlorinated lime, diluted | x | |
| Copper sulfate, 10% aqueous solution | x | |
| Cresol acids | | x |
| Cresol solution | | x |
| Cutting oil | | x |
| Cyclohexane | | x |
| Diesel | | x |
| Diisononyl phthalate | x | |
| Di-Octyl-Phtalat | x | |
| Diluted glucose | x | |
| Diluted glycerol | x | |
| Diluted glycol | x | |
| Diluted phenol | | x |
| Ethanol, non-denaturized | x | |
| Ethylene glycol or propylene glycol | x | |
| Fatty acids | x | |
| Fruit juices | x | |
| Gasoline | | x |

| Plastic housing – Resistance to aggressive media | | |
|--|-----------|--------------------|
| | Resistant | Limited resistance |
| Glycerol | x | |
| Grinding oil | | x |
| Gypsum (see calcium sulfate) | x | |
| Heptane | | x |
| Hexane | | x |
| Hydrogen sulfide | | x |
| Ink | x | |
| Isopropyl alcohol | | x |
| Lactic acid | x | |
| Linseed oil | x | |
| Lubricating oil | x | |
| Mercury | x | |
| Methanol, diluted by 50% | | x |
| Mineral oil | x | |
| Mineral spirits (Avio) | | x |
| Mineral-based oil | x | |
| Mothballs | | x |
| Motor oil | | x |
| n-Butanol | x | |
| Naphthalene | | x |
| Octane | | x |
| Oil IRM 901, 20 °C | x | |
| Oil IRM 902, 20 °C | | x |
| Oil IRM 903, 20 °C | | x |
| Oil | | x |
| Oleic acid | x | |
| Oxalic acid | x | |
| Paraffin oil | x | |
| Petroleum | x | |
| Phthalate | x | |
| Potassium carbonate | x | |
| Potassium chlorate | x | |
| Potassium chloride | x | |
| Potassium chromate | | x |
| Potassium cyanide, aqueous solution | x | |
| Potassium iodide | | x |
| Potassium nitrate | | x |
| Potassium persulfate | | x |
| Potassium sulfate | | x |
| Seawater | x | |
| Silicone oil | x | |
| Soap solution | | x |

| Plastic housing – Resistance to aggressive media | | |
|--|-----------|--------------------|
| | Resistant | Limited resistance |
| Sodium bicarbonate | x | |
| Sodium carbonate | x | |
| Sodium chlorate | x | |
| Sodium chloride (table salt) | x | |
| Sodium hydrogen sulfate, aqueous solution | x | |
| Sodium hydroxide 12.5% (alkaline solution) | | x |
| Sodium nitrate | x | |
| Sodium nitrite | | x |
| Sodium perborate | x | |
| Sodium phosphate | x | |
| Sodium silicate | x | |
| Sodium sulfate | x | |
| Sodium sulfide | x | |
| Sodium thiosulfate (fixing salt/developing film) | x | |
| Solution for developing photographs | x | |
| Stearic acid | x | |
| Succinic acid | x | |
| Sulfur dioxide | | x |
| Sulfur | x | |
| Table salt, aqueous solution | x | |
| Tallow | x | |
| Tartaric acid | x | |
| Tar | | x |
| Transformer oil | x | |
| Tricresyl phosphate | x | |
| Turpentine substitute | | x |
| Urea, diluted | x | |
| Urine | x | |
| Vegetable oil | x | |
| Water | x | |
| White spirits (isopropanol and ethanol) | | x |

Coupler hood

CT-TG1-S TP

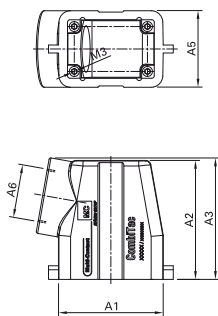

CT-TG...-G TP

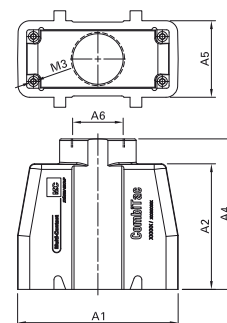

| Size | Order No. | Type | Cable entry | | Sizes (mm) | | | | | |
|-----------------|----------------------------------|----------------------------|-------------|----------|------------|------|----|------|----|-----|
| | | | lateral | straight | A1 | A2 | A3 | A4 | A5 | A6 |
| 1 ¹⁾ | 33.6011 33.6021 | CT-TG1-S TP CT-TG1-G TP | × | × | 63 | 71.5 | 73 | 86.5 | 46 | M32 |
| 2 | 33.6012 33.6022 | CT-TG2-S TP CT-TG2-G TP | × | × | 76 | 71.5 | 73 | 86.5 | 46 | M32 |
| 3 | 33.6013 33.6023 | CT-TG3-S TP CT-TG3-G TP | × | × | 96.5 | 75.5 | 79 | 90.5 | 46 | M32 |
| 4 | 33.6014 33.6024 | CT-TG4-S TP CT-TG4-G TP | × | × | 123 | 75.5 | 79 | 90.5 | 46 | M32 |

Surface mount housing

CT-AG1 TP

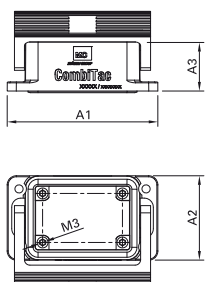

CT-AG...TP

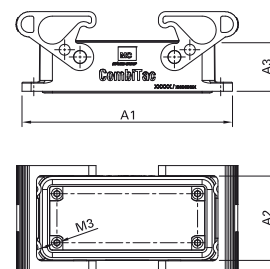

| Size | Order No. | Type | Sizes (mm) | | |
|-----------------|----------------|-----------|------------|----|----|
| | | | A1 | A2 | A3 |
| 1 ¹⁾ | 33.6041 | CT-AG1 TP | 83 | 46 | 27 |
| 2 | 33.6042 | CT-AG2 TP | 96 | 46 | 27 |
| 3 | 33.6043 | CT-AG3 TP | 116 | 46 | 27 |
| 4 | 33.6044 | CT-AG4 TP | 143 | 46 | 27 |

¹⁾ Size 1: housings only have a single locking device.

Pedestal mount housing

CT-SG1 TP

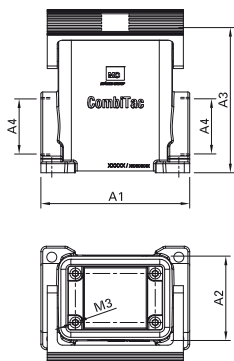

CT-SG...TP

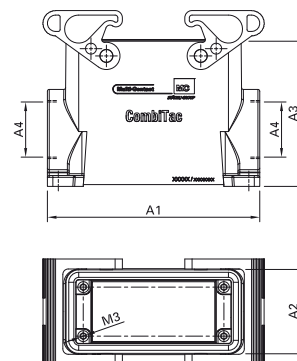

| Size | Order No. | Type | Sizes (mm) | | | |
|-----------------|----------------|-----------|------------|----|----|-----|
| | | | A1 | A2 | A3 | A4 |
| 1 ¹⁾ | 33.6601 | CT-SG1 TP | 82 | 45 | 73 | M32 |
| 2 | 33.6602 | CT-SG2 TP | 94 | 45 | 80 | M32 |
| 3 | 33.6603 | CT-SG3 TP | 117 | 45 | 80 | M32 |
| 4 | 33.6604 | CT-SG4 TP | 144 | 45 | 80 | M32 |

Protective cap

CT-SD-TG1 TP



CT-SD-TG... TP



| Size | Order No. | Type |
|-----------------|----------------|--------------|
| 1 ¹⁾ | 33.6031 | CT-SD-TG1 TP |
| 2 | 33.6032 | CT-SD-TG2 TP |
| 3 | 33.6033 | CT-SD-TG3 TP |
| 4 | 33.6034 | CT-SD-TG4 TP |

¹⁾ Size 1: housings only have a single locking device.

Protective grounding of conductive housings

Appropriate ground protection is available for conductive DIN housings to protect the users against electrical shock, according to IEC 61140¹⁾.

CombiTac conductive DIN housings can be grounded internally through its end pieces or the CombiTac PE module.

Protective grounding through end pieces

For live conductors 0.14 mm² – 6 mm²

(AWG 26 – 10)

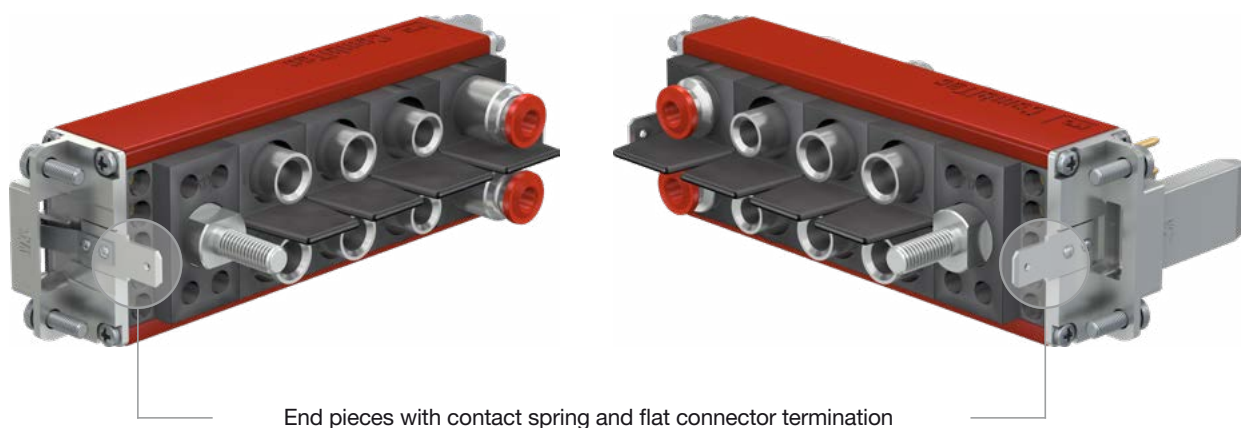

Protective grounding through PE module

For live conductors 10 mm² – 95 mm²

(AWG 8 – 3/0)

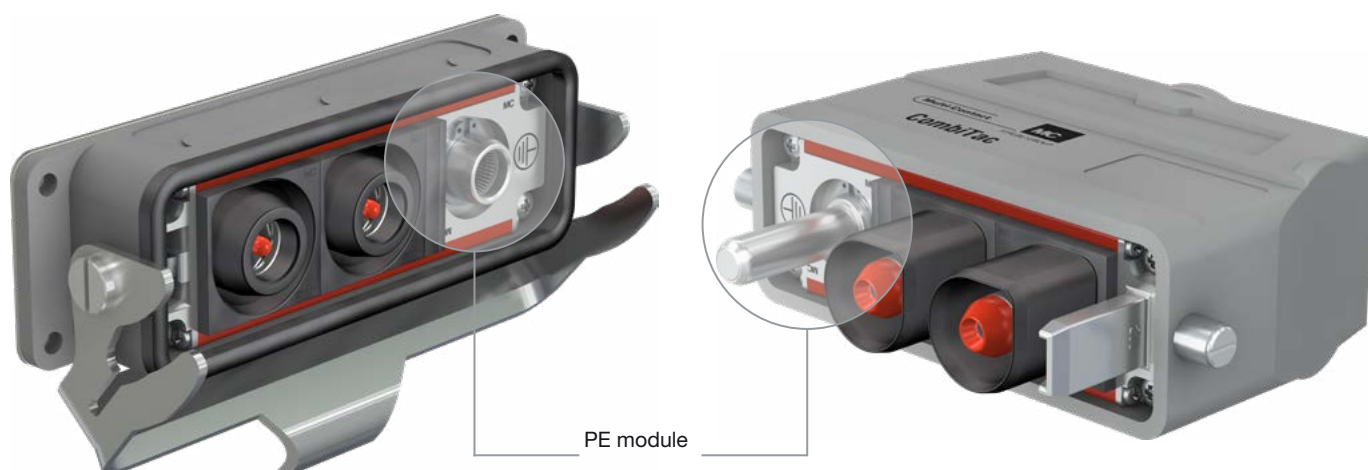

¹⁾ For voltages > 60 V DC or > 30 V AC, metal (conductive) housings must be connected to protective earth (PE).

Protective grounding internally through end pieces



Conductive DIN housings that include live conductors with cross section areas 0.14 mm² – 6 mm² (AWG 26 – 10) can be protective grounded through the CombiTac end pieces.

Type of termination:

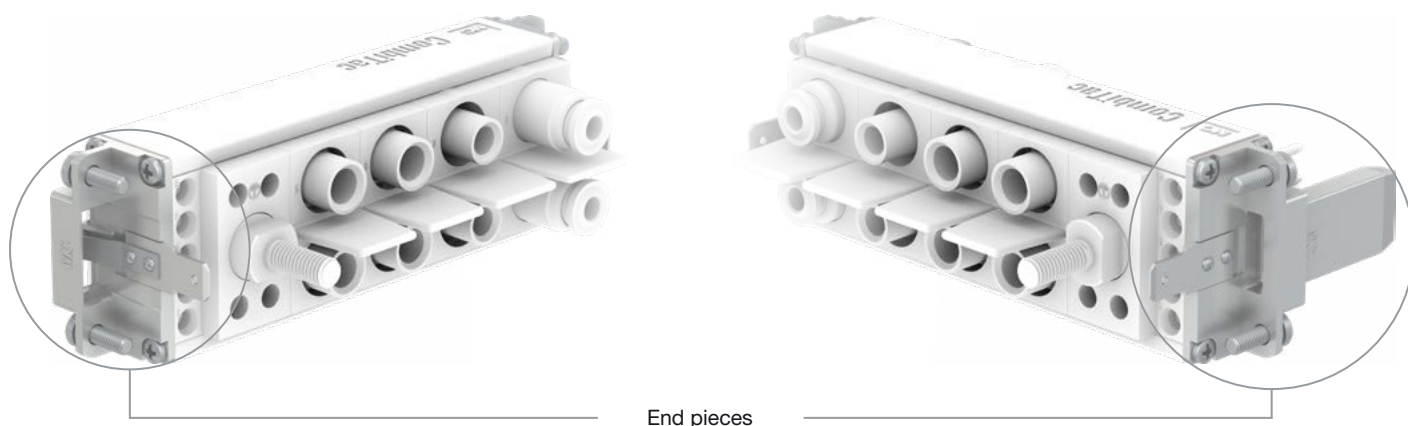
- Flat connector termination 6.3 x 0.8 mm



End pieces

| Order No. | Type | Designation | Number per frame | | |
|-----------|----------|--|------------------|-----|---|
| | | | Socket | Pin | |
| 33.4056 | CT-BEG-B | Standard end piece for DIN housing, socket | 2 | |  |
| 33.4057 | CT-BEG-S | Standard end piece for DIN housing, pin | | 2 |  |

PE module

The CombiTac PE module is used for internal protective grounding of CombiTac conductive DIN housings size 2 – 6.

The PE module carrier replaces one of the end pieces and is directly connected to the housing.

- The size of the PE module contacts is determined by the cross section area of the largest live conductor used in the CombiTac configuration (see selection table page 96).

- Aluminum rails are required to ensure correct grounding of conductive housings.
- Fitted with MULTILAM

CT-GND10 AG

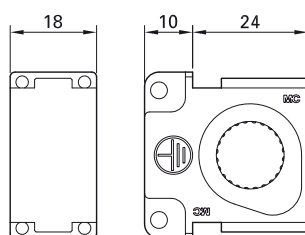

| Order No. | Type | Description |
|-----------|-------------|-------------------|
| 33.4165 | CT-GND10 AG | PE module carrier |

| Technical data | |
|---|--------|
| Number of poles | 1 |
| For contact diameter | 10 mm |
| Contact carrier material | Brass |
| Limiting temperature (IEC 61984), upper | +90 °C |
| lower | -40 °C |

Required tools

For the required tools please refer to MA213-09.



Assembly instructions MA213-09

www.staubli.com/electrical

PE module contacts

For protective grounding purposes only,
used in combination with CT-GND10 carrier.
Fitted with MULTILAM.

Type of termination:

- Crimp termination (C)
- Contacts secured in carrier by means of retaining ring

CT-BP10/.../PE-GND AG

CT-SP10/.../PE-GND AG



Socket side

Pin side

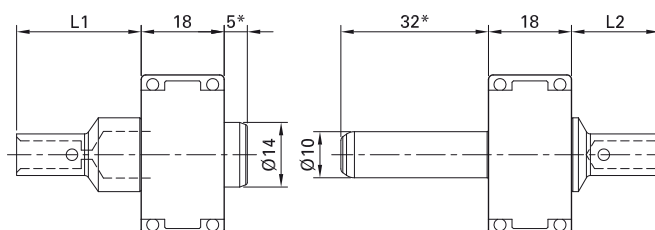

| Order No. | Type | Socket | Pin | Surface | Conductor cross section | | Type of termination |
|--------------------|--|--------|-----|---------|-------------------------|-----|---------------------|
| | | | | | mm ² | AWG | |
| 33.0215 33.0715 | CT-BP10/10/PE-GND AG CT-SP10/10/PE-GND AG | x | x | | 10 | 8 | C |
| 33.0214 33.0714 | CT-BP10/16/PE-GND AG CT-SP10/16/PE-GND AG | x | x | | 16 | 6 | C |
| 33.0216 33.0716 | CT-BP10/25/PE-GND AG CT-SP10/25/PE-GND AG | x | x | | 25 | | C |
| 33.0217 33.0717 | CT-BP10/AWG4/PE-GND AG CT-SP10/AWG4/PE-GND AG | x | x | | | 4 | C |
| 33.0213 33.0713 | CT-BP10/35/PE-GND AG CT-SP10/35/PE-GND AG | x | x | | 35 | 2 | C |
| 33.0212 33.0712 | CT-BP10/50/PE-GND AG CT-SP10/50/PE-GND AG | x | x | | 50 | 1/0 | C |

Technical data

| | |
|--------------------------------|--|
| Nominal-Ø socket/pin | 10 mm |
| Max. sliding force per contact | 15 N |
| Contact resistance | <60 µΩ |
| Mating cycles | 10,000 |
| Vibrations | 4.2 g / 5 – 250 Hz (DIN EN 61373) 10 g / 10 – 500 Hz (DIN EN 60068-2-6) |
| Resistance to shocks | 30 g / 18 ms (DIN EN 61373) |

* Sizes are the same for all types of terminations.



Assembly instructions MA213-09

www.staubli.com/electrical

PE module contacts selection table

According to IEC 61984, the size of a PE conductor cross section depends on the size of the live conductor cross section. In a CombiTac configuration, the size of the largest live conductor determines the size of the PE conductor.

For example, if Ø 12 mm CombiTac contacts are used with 95 mm² live conductor cross sections, then a 50 mm² PE conductor is required (i.e. requires CT-SP10/50/... and CT-BP10/50/...).

The table below indicates the suitable PE contacts and housing size.

| | | mm ² AWG | mm ² AWG | mm ² AWG | mm ² AWG | mm ² AWG | mm ² AWG | mm ² AWG | mm ² AWG |
|--|------------------------|------------------------|------------------------|------------------------|------------------------|------------------------|------------------------|------------------------|------------------------|
| Largest live conductor cross section | | 10 8 | 16 6 | 25 4 | 35 2 | 50 – | – 1/0 | 70 2/0 | 95 3/0 |
| Required PE conductor cross section according to IEC 61984 | | 10 8 | 16 6 | 16 6 | 16 6 | 25 – | – 4 | 35 2 | 50 1/0 |
| Suitable PE module pins/socket | CT-SP10/10/PE-GND AG | x | | | | | | | |
| | CT-BP10/10/PE-GND AG | x | | | | | | | |
| | CT-SP10/16/PE-GND AG | | x | x | x | | | | |
| | CT-BP10/16/PE-GND AG | | x | x | x | | | | |
| | CT-SP10/25/PE-GND AG | | | | | x | | | |
| | CT-BP10/25/PE-GND AG | | | | | x | | | |
| | CT-SP10/AWG4/PE-GND AG | | | | | | x | | |
| | CT-BP10/AWG4/PE-GND AG | | | | | | x | | |
| | CT-SP10/35/PE-GND AG | | | | | | | x | |
| | CT-BP10/35/PE-GND AG | | | | | | | x | |
| | CT-SP10/50/PE-GND AG | | | | | | | | x |
| | CT-BP10/50/PE-GND AG | | | | | | | | x |
| Suitable housing size | 2 | x | x | x | x | | | | |
| | 3 | x | x | x | x | x | x | x | x |
| | 4 | x | x | x | x | x | x | x | x |
| | 5 | x | x | x | x | x | x | x | x |
| | 6 | x | x | x | x | x | x | x | x |



Light housing for testing applications

The CombiTac IP20 plastic light housing with central locking is used in applications that require high density electrical signal connections.

The combination of up to 320 contacts, an ergonomic design with a central locking mechanism, and a removable cover while in mated condition, makes the CombiTac light housing ideal for testing applications.

Features:

- Up to 320 Ø 0.6 mm contacts
- Further combinations for signal and power with contacts up to Ø 6 mm
- 10,000 mating cycles
- 1/4 turn spring locking mechanism
- Straight or lateral cable entry
- Adjustable cable clamp
- 36 coding possibilities
- Quick and easy cover removal for access to contacts in mated condition

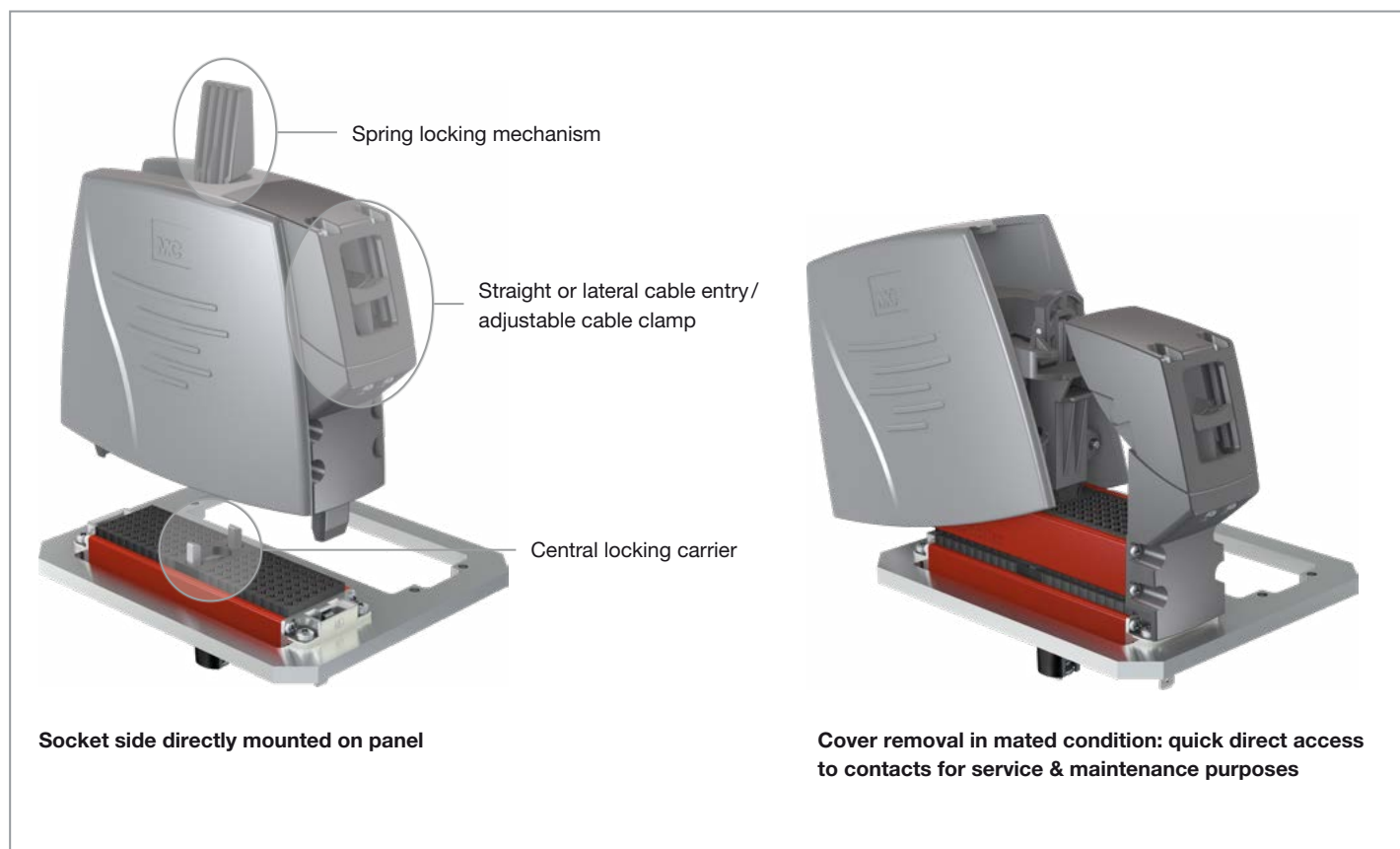

Housing with central locking

CT-LH4

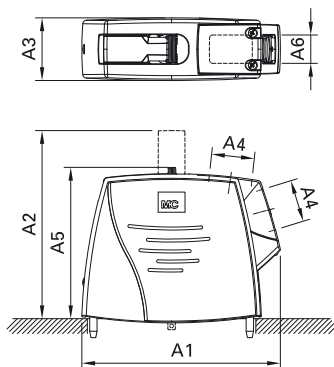

CT-ELHB

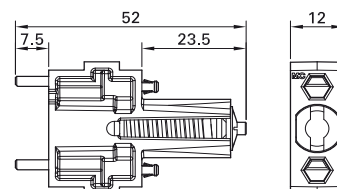

| Order No. | Type | Designation | Sizes (mm) | | | | | |
|-----------|---------|---|------------|-----|----|--------------------|-------|----|
| | | | A1 | A2 | A3 | A4 | A5 | A6 |
| 33.2030 | CT-LH4 | Housing with central locking (pin side) ¹⁾ | 133 | 126 | 42 | min. 5 – max. 24.8 | 101.5 | 19 |
| 33.2023 | CT-ELHB | Central locking carrier (socket side) ¹⁾ | – | – | – | – | – | – |

Technical data

| | |
|--|------------------|
| Degree of protection (in mated condition) | IP20 |
| Mating cycles | 10,000 |
| Housing material | PA |
| Limiting temperature (IEC 61984), upper lower | +90 °C –40 °C |
| Rail length | 94 mm |

Contacts

| Surface | Conductor cross section | | Nom.-Ø contact mm | Rated current A |
|---------|-------------------------|-----|----------------------|--------------------|
| | mm ² | AWG | | |

For signal contacts

| | | | | | |
|--|-------------|---------|-----|---------|--|
| | 0.14 – 0.25 | 26 – 24 | 0.6 | 1.4 – 2 | |
| | 0.25 – 0.75 | 24 – 18 | 1 | 2 – 5 | |
| | 0.5 – 1.5 | 20 – 16 | 1.5 | 5 – 10 | |

For power contacts

| | | | | | |
|--|---------|---------|---|---------|--|
| | 2.5 – 4 | 14 – 12 | 3 | 22 – 35 | |
| | 6 – 16 | 10 – 6 | 6 | 40 – 75 | |

¹⁾ By selecting light housing in the CombiTac configurator, both the housing with central locking (CT-LH4) and socket side central locking carrier (CT-ELHB) are automatically added to the configuration.

CRIMPING PLIERS

Crimping the electric contacts

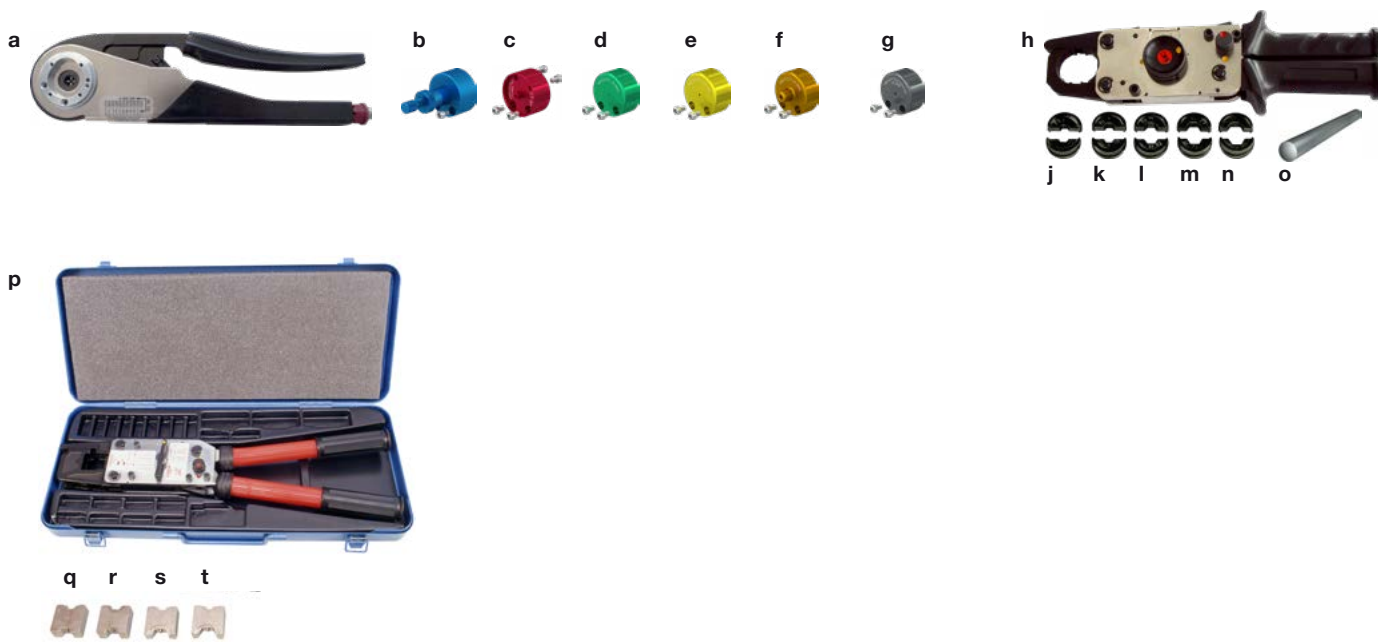

| Pos. | Order No. | Type | Conductor cross section | Description |  |
|------|-----------|----------------------|---|---|---|
| a | 33.3800 | CT-M-CZ | | Crimping pliers | MA079 MA213-11 |
| b | 18.3801 | MES-CZ | 0.14 – 4 mm ² | Locator adjustable (except for Ø 0.6 mm contacts) | MA079 |
| c | 18.3809 | MES-CZ-CT 0,6 | 0.14 – 0.25 mm ² | Locator | |
| d | 18.3804 | MES-CZ-CT1 | 0.25 – 0.75 mm ² | Locator | |
| e | 18.3805 | MES-CZ-CT1,5 | 0.5 – 1.5 mm ² | Locator | |
| f | 18.3806 | MES-CZ-CT3 | 2.5 – 4 mm ² | Locator | |
| g | 18.3808 | MES-CZ-CT0,6-COAX-RG | | Locator for Coaxial unit 6 GHz | MA079 MA213-11 |
| h | 18.3700 | M-PZ13 | | Crimping pliers | MA224 |
| j | 18.3701 | MES-PZ-TB5/6 | 6 mm ² | Insert | |
| k | 18.3702 | MES-PZ-TB 8/10 | 10 mm ² | Insert | |
| l | 18.3703 | MES-PZ-TB 9/16 | 16 mm ² | Insert | |
| m | 18.3704 | MES-PZ-TB11/25 | 25 mm ² | Insert | |
| n | 18.3707 | MPS-PZ13 | | Test insert | |
| o | 18.3708 | MALU-PZ13 | | Round test rod | |
| p | 18.3710 | M-PZ-T2600 | | Crimping pliers with case | MA213-01 |
| q | 18.3712 | TB9-13 | 16 mm ² + 35 mm ² | Insert | |
| r | 18.3713 | TB11-14,5 | 25 mm ² + 50 mm ² | Insert | |
| s | 18.3711 | TB8-17 | 10 mm ² + 70 mm ² | Insert | |
| t | 18.3714 | TB7-20 | 95 mm ² | Insert | |

Crimping the 1.5 GHz coaxial contacts



| Pos. | Order No. | Type | Description | MA |
|----------|----------------|--------------|---|----------|
| a | 33.3011 | CT-AIWZ/COAX | Insulation stripper for Coaxial unit 1.5 GHz | MA213-02 |
| b | 33.3010 | CT-CZ/COAX | Crimping pliers for shield and inner conductor for Coaxial unit 1.5 GHz | MA213-02 |





Crimping the plastic optical fiber contacts



| Pos. | Order No. | Type | Description | MA |
|----------|----------------|-------------|---------------------|-----------------|
| a | 33.3021 | CT-AIWZ/POF | Insulation stripper | MA213-03 |
| b | 33.3023 | CT-PS/POF | Polishing disc | MA213-03 |
| c | 33.3020 | CT-CZ/POF | Crimping pliers | MA065, MA213-03 |

ASSEMBLY TOOLS

Insertion tools socket/pin

| Insertion tool | Order No. | Type | For nominal-Ø socket/pin | For contact |
|--|----------------|-----------------------|--------------------------|-------------------------------|
|  | 33.3003 | CT-E-WZ0,6 | 0.6 mm | |
|  | 33.3001 | CT-E-WZ1-9,5 | 1 mm | Thermocouple contacts |
|  | 18.3003 | ME-WZ1,5/2 | 1.5 mm | |
| | 18.3010 | ME-WZ3 | 3 mm | |
| | 18.3013 | ME-WZ5 | 6 mm | CT-POF/SL Coaxial contacts |
| | 18.3016 | ME-WZ6 | 8 mm | |
|  | 18.3015 | MSA-WZ5 ¹⁾ | 6 mm | |
| | 18.3018 | MSA-WZ6 ¹⁾ | 8 mm | |
|  | 18.3014 | MBA-WZ5 ²⁾ | 6/8 mm | |

Extraction tools socket/pin

| Extraction tool (socket) | Order No. | Type | For nominal-Ø pin/socket | For contact |
|--|----------------|--------------------------|--------------------------|-----------------------|
|  | 33.3002 | CT-A-WZ0,6 | 0.6 mm | |
|  | 18.3001 | MBA-WZ1/1,2 | 1 mm | |
| | 18.3004 | MBA-WZ1,5 | 1.5 mm | Thermocouple contacts |
| | 18.3011 | MBA-WZ3 | 3 mm | |
| | 18.3017 | MBA-WZ6 | 6/8 mm | |
|  | 18.3015 | MSA-WZ5 | | Coaxial contacts |
|  | 33.3022 | CT-AWZ/POF ³⁾ | | POF contacts |
|  | 33.3048 | CT-NET-AWZ | | CT-NET contacts |

| Extraction tool (pin) | Order No. | Type | For nominal-Ø pin/socket | For contact |
|--|----------------|-------------|--------------------------|-----------------------|
|  | 33.3002 | CT-A-WZ0,6 | 0.6 mm | |
|  | 18.3002 | MSA-WZ1/1,2 | 1 mm | |
| | 18.3005 | MSA-WZ1,5 | 1.5 mm | Thermocouple contacts |
| | 18.3012 | MSA-WZ3 | 3 mm | |
| | 18.3018 | MSA-WZ6 | 6 mm | CT-POF/SL |
| | 18.3022 | MSA-WZ8 | 8 mm | Coaxial contacts |

¹⁾ For contacts with screw connection with external thread.

²⁾ For contacts with screw connection with internal thread.

³⁾ Extraction tool for pin and socket.

Torque wrench¹⁾



| Description | Used for | Key size | | Tightening torque | |
|--|--|----------|--------|--|--|
| | | Ø 8 mm | Ø 6 mm | Ø 8 mm (M6) | Ø 6 mm (M5) |
| Torque wrench for hex. socket head screw | Fitting cable lug on Ø 8 and 6 mm contacts | 5 mm | 4 mm | 3 Nm ²⁾ 8.5 Nm ³⁾ | 2 Nm ²⁾ 5 Nm ³⁾ |
| Insert for cross recessed screws | Cross recessed screws for supporting rail | | | 0.5 Nm | |



| Description | Used for | Key size | | Tightening torque | |
|--------------------------------|-------------------|----------|--------|--|--|
| | | Ø 8 mm | Ø 6 mm | Ø 8 mm (M6) | Ø 6 mm (M5) |
| Torque wrench | Fitting cable lug | 10 mm | 8 mm | 3 Nm ²⁾ 8.5 Nm ³⁾ | 2 Nm ²⁾ 5 Nm ³⁾ |
| Open-end spanner ¹⁾ | Fitting cable lug | 8 mm | 7 mm | | |

Special tool

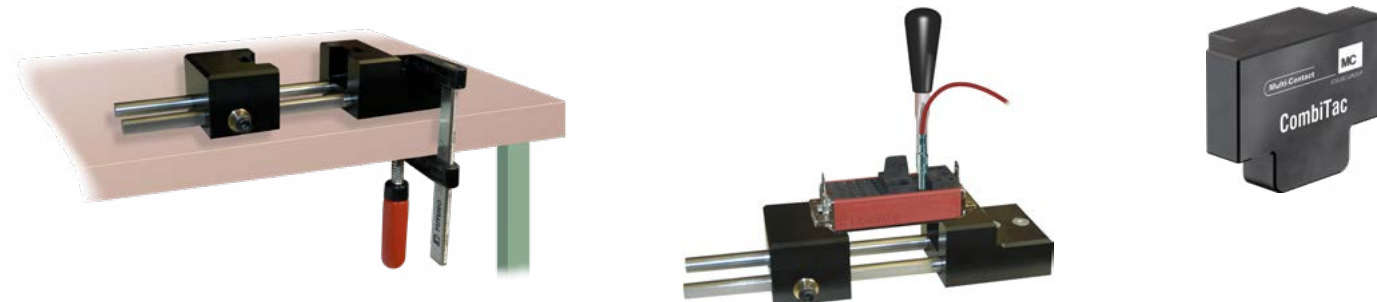

| Description | Used for |
|---------------------------------|---|
| Special tool CT-K-WZ 33.3040 | For easy insertion of the contacts into the contact carrier. Adjustable fixing of the CombiTac units for frame sizes from 18 – 120 mm. It can be fixed on the table with a bar clamp or screws. With anti-slide surface on the underside. |
| Insert CT-K-WZ-AFL 33.3042 | Inserting sockets into the CT-E8-2-IP2X (33.4139) contact carrier with the CT-K-WZ special tool. |

¹⁾ Parts available commercially.

²⁾ For internal and external thread.

³⁾ Only for steel screws.

APPENDIX

Derating diagrams

Derating with the use of cables

The derating diagrams for cables are based on the German standards DIN VDE 0298-4 and DIN VDE 0891-1. The diagrams show examples of the rated current in correlation with changes in the ambient temperature. If a CombiTac is used to equip machines, standard IEC 60204-1 is applicable instead of VDE 0298-4.

Derating with the use of CombiTac in machines

In this case, the standard IEC 60204-1 “Safety of Machines” is applicable. This specifies the permitted current load of PVC-insulated copper wire and cables under continuous current when used in machines, at an ambient temperature of 40 °C. For bundled wires and cables under these conditions, additional reduction factors apply.

Example 1:

1 and 2 current-carrying conductors (bundled) according to DIN VDE 0298-4 for 50 mm², 70 mm², and 95 mm² Cu wire, PVC insulated for higher temperatures (max. permitted conductor temperature of 90 °C).

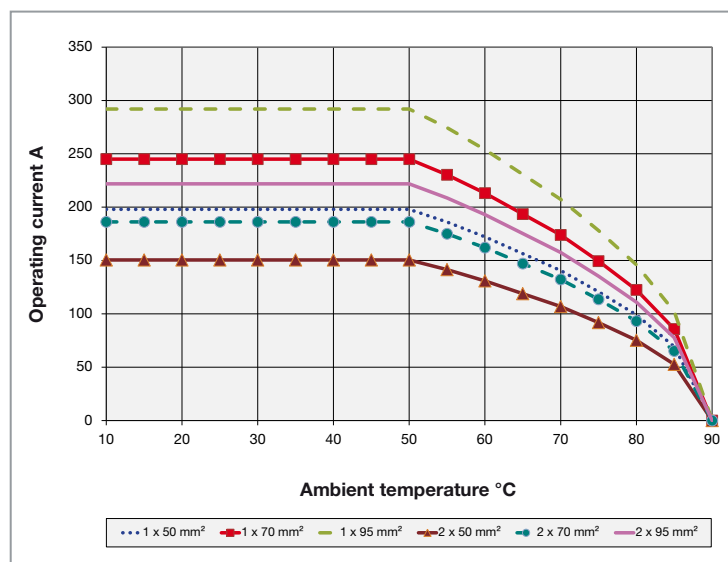

Example 2:

2 and 6 current-carrying conductors (bundled) according to DIN VDE 0298-4 for 25 mm², and 35 mm² Cu wire, PVC insulated for higher temperatures (max. permitted conductor temperature of 90 °C).

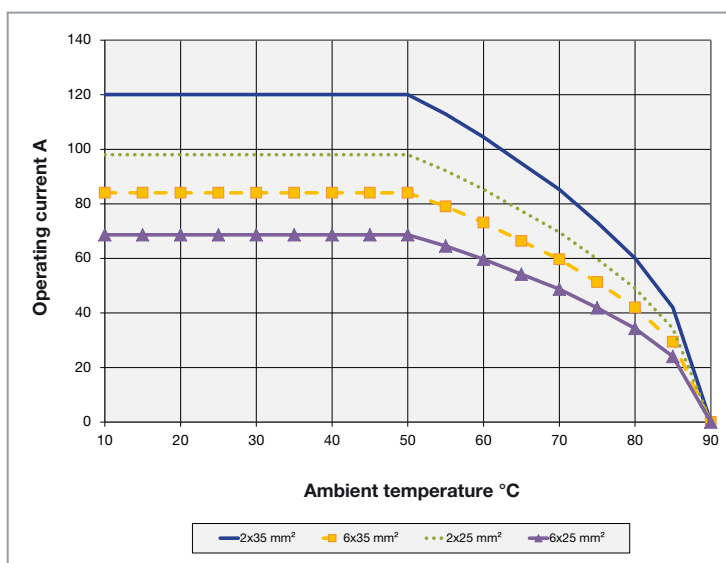

Example 3:

2 and 6 current-carrying conductors (bundled) according to DIN VDE 0298-4 for 10 mm², and 16 mm² Cu wire, PVC insulated for higher temperatures (max. permitted conductor temperature of 90 °C).

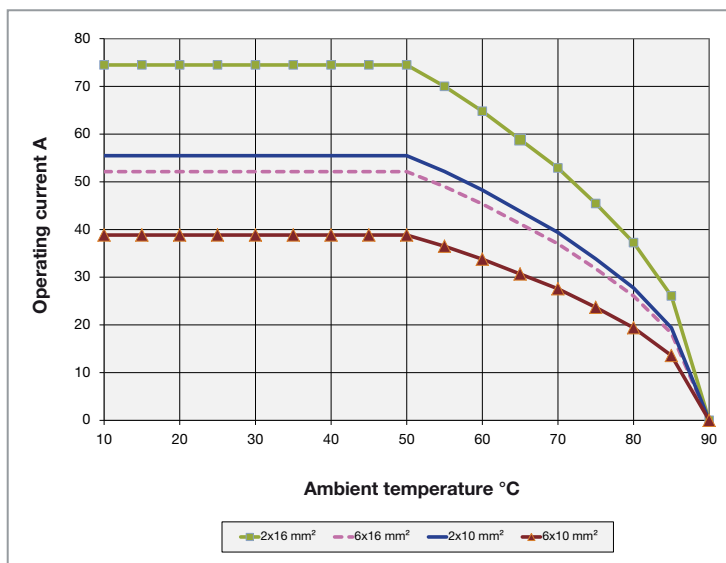

Example 4:

2 and 6 current-carrying conductors (bundled) according to DIN VDE 0298-4 for 2.5 mm², 4 mm², and 6 mm² Cu wire, PVC insulated for higher temperatures (max. permitted conductor temperature of 90 °C).

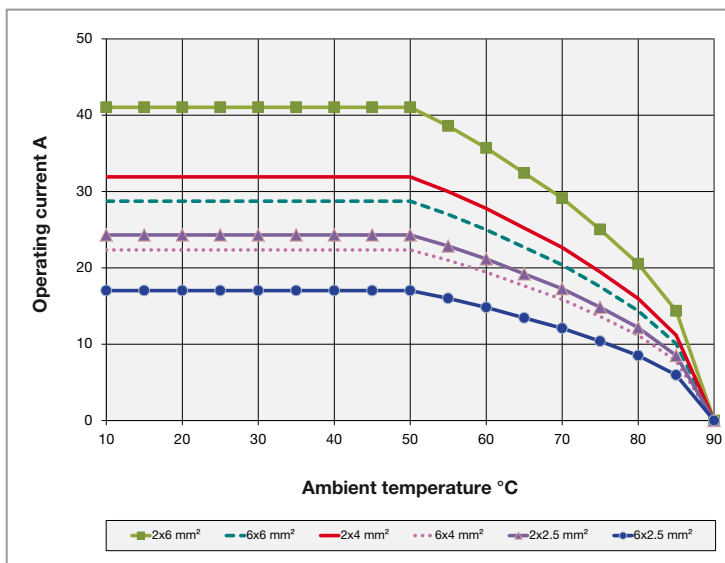

Example 5:

2, 4, and 10 current-carrying conductors (bundled) according to DIN VDE 0298-4 for 1 mm² and 1.5 mm² Cu wire, PVC insulated for higher temperatures (max. permitted conductor temperature of 90 °C).

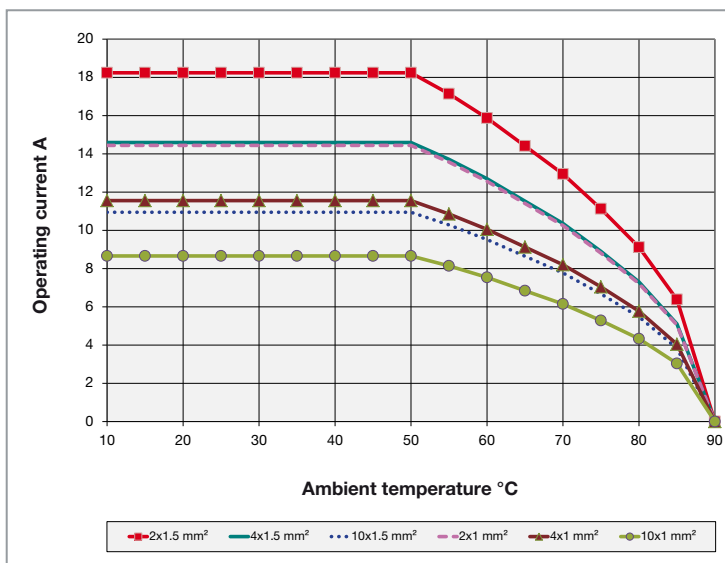

Example 6:

2, 4, 6, 10, 16, and 28 current-carrying conductors (bundled) according to DIN VDE 0298-4 for 0.75 mm² Cu wire, PVC insulated for higher temperatures (max. permitted conductor temperature of 90 °C).

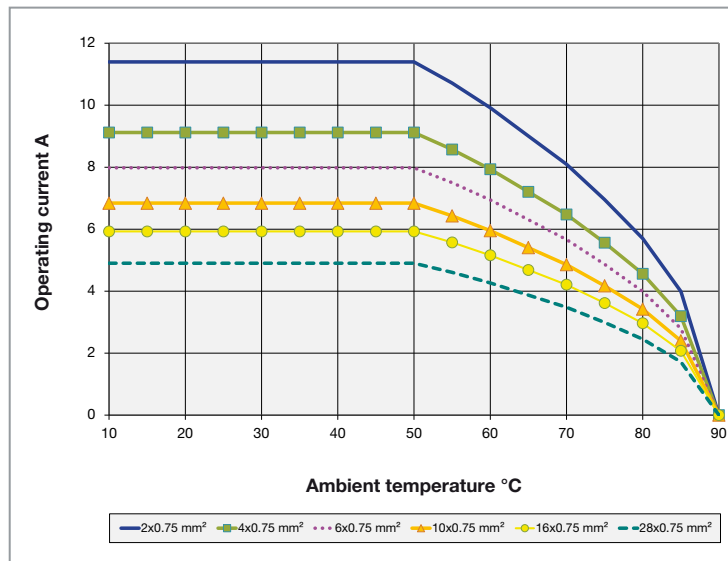

Example 7:

2, 4, 6, 10, 16, and 28 current-carrying conductors (bundled) according to DIN VDE 0891-1 for 0.5 mm² Cu wire, PVC insulated for higher temperatures (max. permitted conductor temperature of 90 °C).

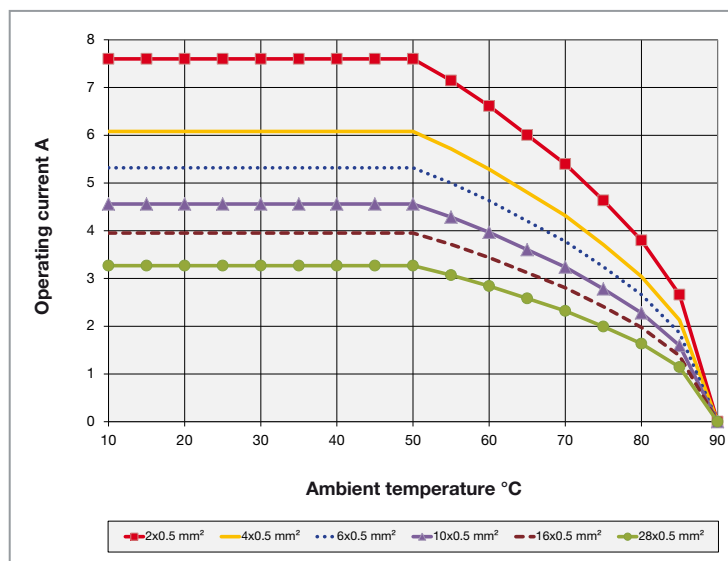

Example 8:

6, 16, and 28 current-carrying conductors (bundled) according to DIN VDE 0891-1 for 0.25 mm² Cu wire, PVC insulated for higher temperatures (max. permitted conductor temperature of 90 °C).

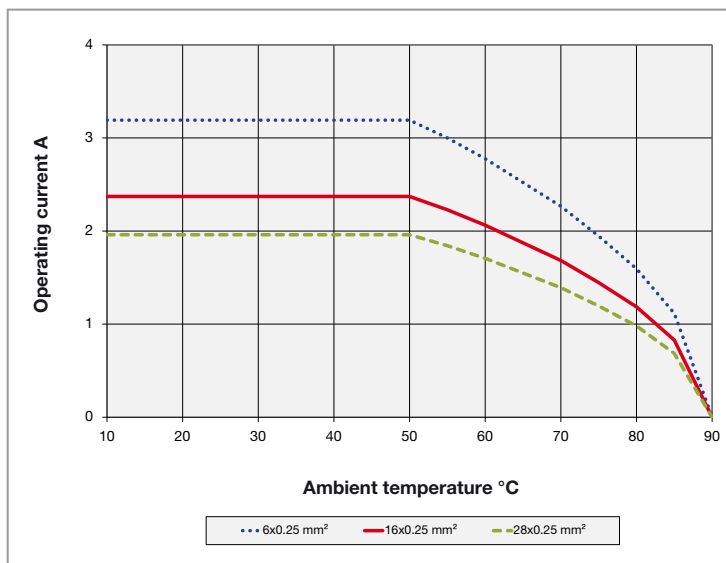

Flow, head loss diagrams, and sliding forces

Test conditions CT-...-UCT04/6, CT-...-RCT03/6

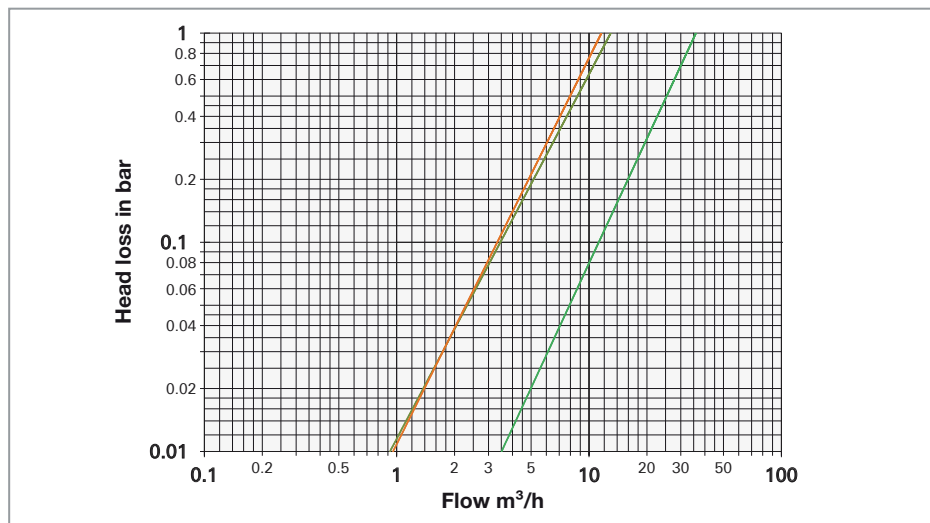

Compressed air:

Under standard conditions 0 °C, 1013 mbar

| Socket | Flow direction | Plug | Max. sliding force | | Input pressure | Tube-Ø |
|-----------------------------|----------------|--------------|--------------------|--------|----------------|--------|
| | | | 0 bar | 15 bar | | |
| CT-B-UCT04/6 ¹⁾ | → | CT-S-UCT04/6 | 9 N | 46 N | 6 bar | 6 mm |
| CT-BV-RCT03/6 ¹⁾ | → ← | CT-S-RCT03/6 | 12 N | 35 N | 6 bar | 6 mm |

Test conditions CT-...-RCT03/6

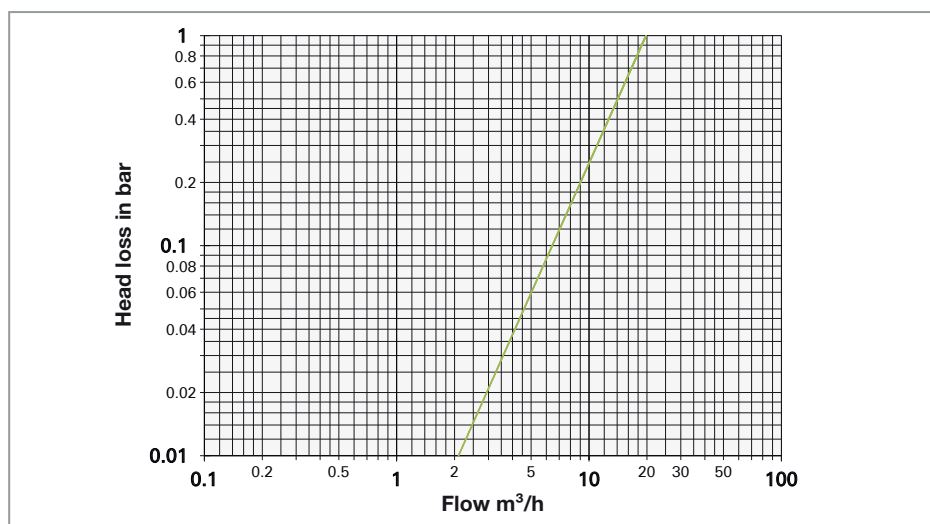

Compressed air:

Under standard conditions 0 °C, 1013 mbar

| Socket | Flow direction | Plug | Max. sliding force | | Input pressure | Tube-Ø |
|--------------|----------------|--------------|--------------------|--------|----------------|--------|
| | | | 0 bar | 15 bar | | |
| CT-B-RCT03/6 | → | CT-S-RCT03/6 | 10 N | 33 N | 6 bar | 6 mm |

¹⁾ Without shut-off valve

Test conditions CT-...-UCT06/8

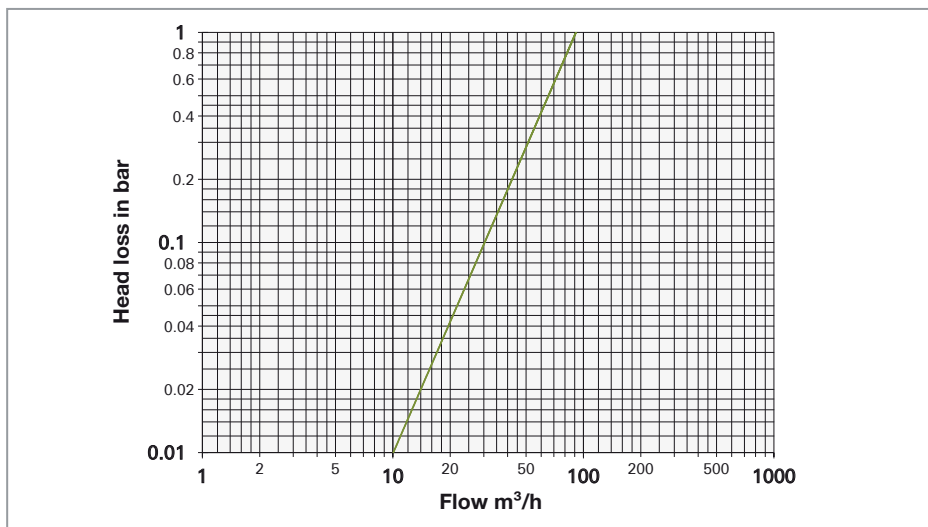

Compressed air:
Under standard conditions 0 °C, 1013 mbar

| Socket | Flow direction | Plug | Max. sliding force | | Input pressure | Tube-Ø |
|--------------|----------------|--------------|--------------------|--------|----------------|--------|
| | | | 0 bar | 15 bar | | |
| CT-B-UCT06/8 | | CT-S-UCT06/8 | 16.5 N | 94 N | 6 | 6 |

Test conditions CT-...-UCT08/10, CT-...-RCT06/8

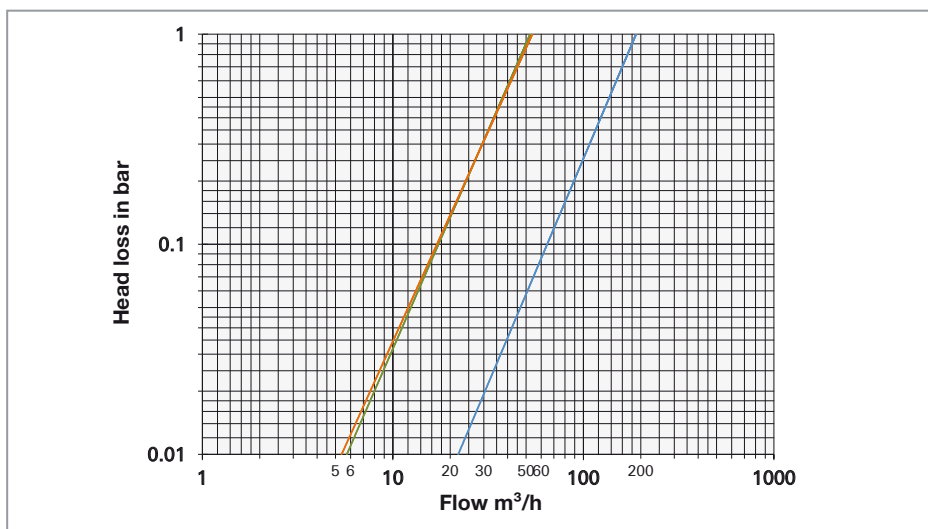

Compressed air:
Under standard conditions 0 °C, 1013 mbar

| Socket | Flow direction | Plug | Max. sliding force | | Input pressure | Tube-Ø |
|-----------------------------|----------------|---------------|--------------------|--------|----------------|--------|
| | | | 0 bar | 15 bar | | |
| CT-B-UCT08/10 ¹⁾ | | CT-S-UCT08/10 | 16 N | 134 N | 6 | 10 |
| CT-BV-RCT06/8 | | CT-S-RCT06/8 | 19 N | 106 N | 6 | 8 |
| | | | | | | |

¹⁾ Without shut-off valve

Test conditions CT-...-SCT03

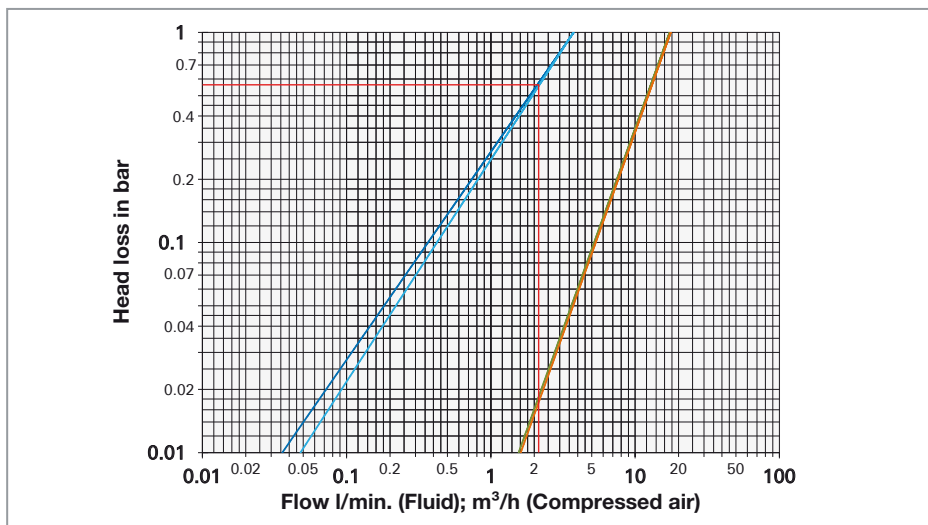

Fluid:

Hydraulic oil INVAROL FJ13 (H515) with 40 °C (volumetric mass 833 kg/m³).

Compressed air:

Under standard conditions 0 °C, 1013 mbar

- Hydraulic
- Pneumatic
- Flow rate 5 m/s

| Socket | Flow direction | Plug | Viscosity | Input pressure | Tube-Ø |
|----------------------------|----------------|--------------------------|-----------|----------------|--------|
| | | | cSt | bar | mm |
| CT-B-SCT03 ¹⁾²⁾ | | CT-S-SCT03 ¹⁾ | 13.4 | – | 6 |
| CT-B-SCT03 ¹⁾²⁾ | | CT-S-SCT03 ¹⁾ | – | 6 | 6 |

Test conditions SCT05

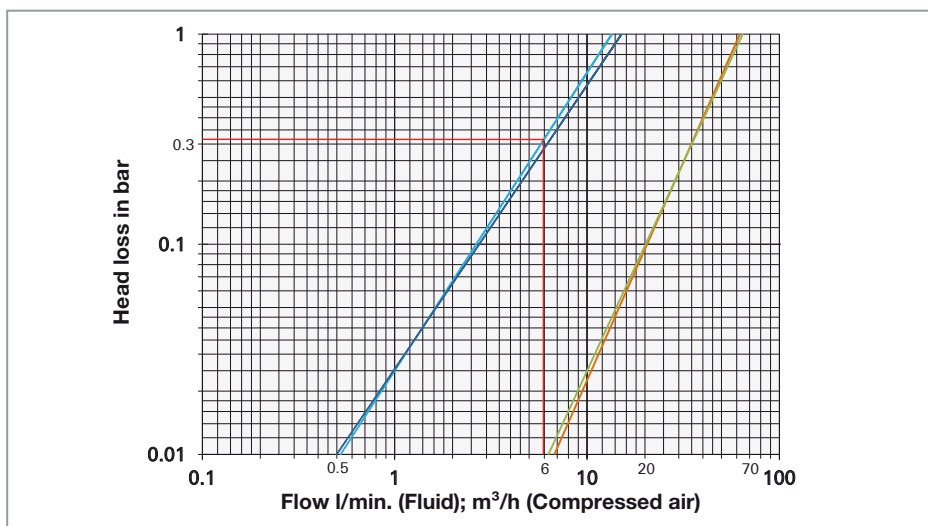

Fluid:

Hydraulic oil INVAROL FJ13 (H515) with 40 °C (volumetric mass 833 kg/m³).

Compressed air:

Under standard conditions 0 °C, 1013 mbar

- Hydraulic
- Pneumatic
- Flow rate 5 m/s

| Socket | Flow direction | Plug | Viscosity | Input pressure | Tube-Ø |
|----------------------------|----------------|--------------------------|-----------|----------------|--------|
| | | | cSt | bar | mm |
| CT-B-SCT05 ¹⁾²⁾ | | CT-S-SCT05 ¹⁾ | 13.4 | – | 8 |
| CT-B-SCT05 ¹⁾²⁾ | | CT-S-SCT05 ¹⁾ | – | 6 | 8 |

¹⁾ Recommendation: do not engage under pressure

²⁾ Leakproof with shut-off valve

Technical information

Sliding forces

The total sliding force of a connector is the sum of all the single contact sliding forces. The stated values are guideline values, and may be reduced by 20 – 30 % after a number of mating cycles.

Locking cycles DIN housing

Max. 500 locking cycles without lubrication. For up to 5000 locking cycles, a lubrication must be executed. See note about lubrication, assembly instructions MA213.

Rated current

The rated current is the current, preferably at an ambient temperature of 40 °C, that the plug connector or plug device can carry continuously (without interruption) and that flows simultaneously through all its contacts that are connected to the largest possible conductor without the maximum permitted temperature being exceeded. The stated current values were determined in accordance with UL1977 (4-hour temperature test, contacts connected in series).

Bundled wires

If the CombiTac is used together with bundled wires, a reduction factor must be applied to the wires. The derating diagrams on pages 104 – 108 show various examples for bundled copper wires with different cross sections that are suitable for use with CombiTac. The specified wires are PVC insulated with increased heat resistance (max. permissible conductor temperature 90 °C) in accordance with DIN VDE 0298, part 4, and DIN VDE 0891-1. A specific derating factor applies to a given number of bundled wires or types of wire.

Rated voltage IEC 60664-1

Value of voltage assigned by the manufacturer, to a component, device, or equipment and to which operation and performance characteristics are referred. Equipment may have more than one rated voltage value or may have a rated voltage range.

The rated voltages listed below correlate normatively with the following impulse withstand voltages. This is subject to the overvoltage category to be met.

Overvoltage categories

The concept of overvoltage categories is used for equipment energized directly from the low-voltage mains.

CATII: Equipment of the overvoltage category II is energy consuming equipment to be supplied from the fixed installation. Examples of such equipment are appliances, portable tools, and other household and similar loads.

| IEC 60664-1 | | | IEC 61984 | |
|----------------|---------------------------|--------------------------|---|--------------------------|
| Rated voltage | Impulse withstand voltage | | r.m.s withstand voltage 1 min, 50/60 Hz | |
| | Overvoltage category II | Overvoltage category III | Overvoltage category II | Overvoltage category III |
| < 51 V | 500 V | 800 V | 370 V | 500 V |
| 51 V – 100 V | 800 V | 1500 V | 500 V | 840 V |
| 101 V – 150 V | 1500 V | 2500 V | 840 V | 1390 V |
| 151 V – 300 V | 2500 V | 4000 V | 1390 V | 2210 V |
| 301 V – 600 V | 4000 V | 6000 V | 2210 V | 3310 V |
| 601 V – 1000 V | 6000 V | 8000 V | 3310 V | 4260 V |

Pollution degree 2 IEC 60664-1

Normally only nonconductive pollution occurs. Occasionally, however, temporary conductivity caused by condensation is to be expected.

CATIII: Equipment of overvoltage category III is equipment in fixed installations and for cases where the reliability and the availability of the equipment is subject to special requirements. Examples of such equipment are switches in the fixed installation and equipment for industrial use with a permanent connection to the fixed installation.

Pollution degree 3 IEC 60664-1

Presence of conductive pollution or of dry nonconductive pollution that becomes conductive due to condensation that is to be expected.

CATIV: Equipment of overvoltage category IV is for use at the origin of the installation. Examples of such equipment are electricity meters and primary overcurrent protection equipment.

Silicone free

The contact carriers of the CombiTac connectors are silicone free and therefore not detrimental to paint adhesion.

Contact resistance

The contact resistance is determined by means of the voltage drop, measured between the lead terminations of the pin and socket. The stated values are mean values derived from the rated current after 100 mating cycles.

Mating cycles

Mating cycles tests for CombiTac parts are performed under typical laboratory environmental conditions.

Limiting temperature

The limiting temperatures specified in this catalog apply to CombiTac connectors while in mated condition.

Safety notes

Protection against electric shock

A connector shall be so designed that, after mounting, its live parts are not accessible by the IEC test finger in accordance with clause 5 of IEC 60529 using a test force of 20 N. Some CombiTac modules are not contact-protected on the cable connection side. These products are designed to be built into a housing that guarantees the relevant IP protection for cable connections (at least IP2X). Protection against electric shock must be provided by the end product and ensured by the users themselves. This requirement does not apply to a connector operated with a safety extra-low voltage (SELV) of a maximum AC 50 V eff. or DC 120 V. The customer must take appropriate measures when fitting the connectors to ensure that the cable connection is protected against tension and twisting and is responsible for correct implementation of the contact-protection measures. Connection and disconnection only when not live.

Enclosure

An enclosed connector is a connector for which the protection against electric shock is ensured by the housing of the connector itself. An unenclosed connector is a connector for which the protection against electric shock is provided by the enclosure of the equipment in which the connector is mounted.

In relation to the direction of power flow, connectors should be incorporated in the circuit wiring in such a way that pins that can be touched are not live in the unmated state (IEC 61984).

Protection wall

In order to meet the requirement for protection against accessibility of live parts up to AC 600 V during engagement or withdrawal, CombiTac is provided with a specially designed protection wall. Measures shall be taken to ensure that insertion and withdrawal is done under no load (0 A) (see page 116 "Safety situation for CombiTac connectors").

Electrical contacts in close proximity to connectors for liquids and gases

Defect electrical contacts or connectors that leak gas or liquids can be a safety hazard to personnel and the environment, as well as affecting the proper function of the system. It is the responsibility of the end user to ensure that both safety and proper function in the end use is guaranteed. The result of a risk analysis requires that the end user of CombiTac connectors must ensure the following:

- All relevant national and international standards and regulations must be complied with in the end use.
- Field-tested techniques must be applied and, if necessary, a risk assessment must be carried out in order to identify and reduce the risks.
- The use of flammable or explosive liquids or gases is prohibited.
- Exclusively CT-...SCT couplings with both male- and female-sided locking systems are permitted to be used for liquids.
- Automatic disconnection of power supply in the event of indirect contact, overload, or short circuit is required according to IEC 60364-4-41.

- If the voltage is higher than AC 33 V or DC 70 V, all simultaneously accessible conductive parts that do not carry current during normal operation must be connected to the protective conductor (protective equipotential bonding according to IEC 60364-4-41).
- If the voltage is higher than AC 33 V or DC 70 V, all electric circuits have to be protected by a residual-current-operated protective device (RCD) with a rated residual operating current not exceeding 30 mA according to IEC 60364-4-41.
- Connecting or disconnecting under load or live is not allowed (connector without breaking capacity according to IEC 61984).
- On permanently fixed installations, electrical contacts have to be placed above liquid couplings.
- In CombiTac housing applications, the housing has to be connected to the protective conductor according to IEC 60364-4-41.
- The maximum rated voltage phase to neutral conductor is AC/DC 600 V.
- The fluid couplings must be replaced if a leak is detected.

2011/65/EC

All components in this catalog comply with the RoHS (2011/65/EC).

Underwriters Laboratories Standard UL

1977 states: A connector operated above 30 V (42 V peak) up to 600 V AC or DC intended for usage external to the end equipment shall have live parts protected against exposure to contact by persons when assembled, installed, and mated as intended, as determined by the use of the articulate

probe with web stop (UL test finger).

Mating devices operated above 30 V (42 V peak) up to 600 V AC or DC intended for usage external to the end equipment shall not have exposed live contacts during engagement or withdrawal, as determined by the use of the articulate probe with web stop (UL test finger).

Engineering considerations according to UL File E229145

File E229145, Vol. 1, Sec. 4

ENGINEERING CONSIDERATIONS:

Use For use only in complete equipment where the acceptability of the combination is determined by Underwriters Laboratories Inc.

Conditions of Acceptability In order to be judged acceptable as a component of electrical equipment, the following conditions should be met. These devices have not been tested for interrupting the flow of current by connecting or disconnecting the mating connector. These devices should be used only where they will not interrupt the flow of current.

These devices have been subjected to the temperature test within the provided housings with the rated currents and maximum temperature rise values tabulated below. The conductors terminated by the device and other associated components are to be reviewed in the end use to determine whether the temperature rise from the connector exceeds their maximum operating temperature ratings.

| Contact | Gauge | Current | Max. Temperature Rise | Contact | Gauge | Current | Max. Temperature Rise |
|------------|-------|---------|-----------------------|---------|-------|---------|-----------------------|
| Ø mm | AWG | (A) | (°C) | Ø mm | AWG | (A) | (°C) |
| 12 (Crimp) | 3/0 | 300 | 58 | 6 | 4 | 75 | 31 |
| 12 (Crimp) | 2/0 | 245 | 60 | 6 | 6 | 55 | 30 |
| 12 (Crimp) | 1/0 | 200 | 62 | 6 | 8 | 40 | 29 |
| 12 (Screw) | 3/0 | 300 | 65 | 3 | 12 | 24.5 | 64 |
| 12 (Screw) | 2/0 | 245 | 57 | 3 | 14 | 22 | 65 |
| 12 (Screw) | 1/0 | 200 | 54 | 3 | 10 | 35 | 24 |
| 8 | 2 | 150 | 45 | 1.5 | 16 | 10 | 65 |
| 8 | 2 | 120 | 24 | 1.5 | 18 | 5 | 16 |
| 8 | 2 | 100 | 30 | 1.5 | 20 | 3 | 12 |
| 8 | 4 | 75 | 27 | 1 | 18 | 5 | 61 |
| 8 | 6 | 55 | 100 | 1 | 20 | 3 | 37 |
| 6 | 4 | 100 | 38 | | | | |

These devices may be used at potentials not exceeding 600 V based on dielectric voltage-withstand testing conducted between adjacent poles and between live parts and dead metal at 2,200 V ac. These devices meet the minimum 1/8 inch (3.2 mm) spacings required by UL 1977 for devices not exceeding 600 V.

The operating temperature of these devices should not exceed the temperature ratings of the insulating materials. These materials may be used interchangeably at a maximum temperature of 90 °C. Mold stress relief testing was conducted at a temperature of 100 °C.

The acceptability of the quick-connect tab as a grounding terminal shall be determined in the end use.

The printed-wiring-board terminals have not been evaluated for mechanical secureness. The construction of the connector is to be reviewed when it is assembled to the particular printed wiring board used in the end use application.

The strain relief device on the housing of the connectors has not been evaluated. This construction shall be determined in the end use.

Safety situation for CombiTac connectors

Engaged or disengaged when CombiTac is isolated from supply

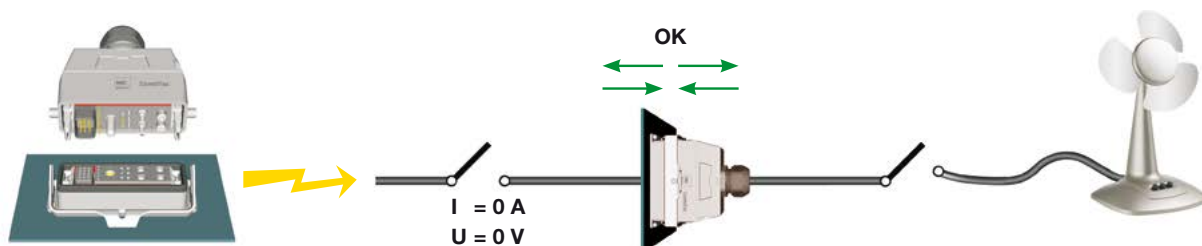

Engaged or disengaged when live and under no load

With protection wall

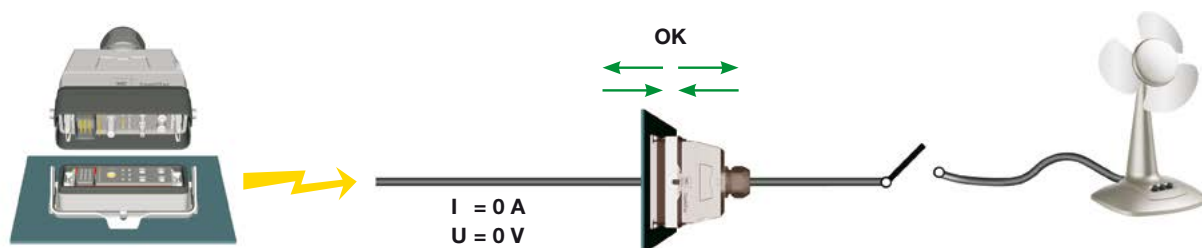

⚠ Attention

When disengaged, the female part is touch protected, i.e. has IP2X protection according

to IEC 60529 (test finger). See also page 115 of the CombiTacline catalog, section "Underwriters Laboratories standard UL 1977".

Engaged or disengaged when live and under load

With or without protection wall

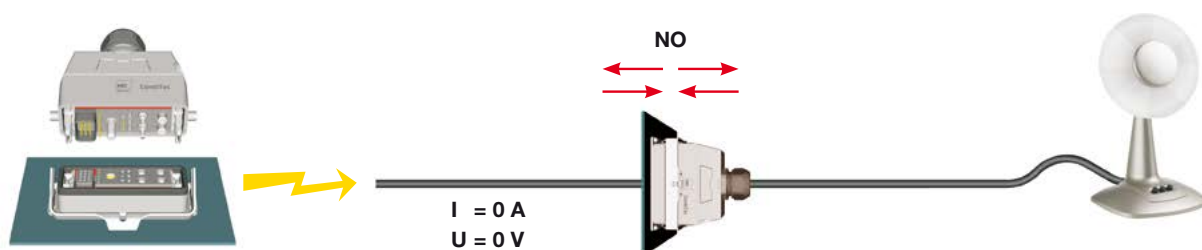

Panel-mounted version

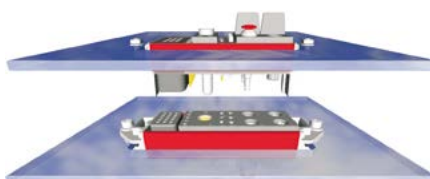

The protection against electric shock is provided by the enclosure of the equipment in

which it is installed. This is provided by the CombiTac end user.



Applications

CombiTac in an automated radio testing station for the automotive industry.
The connector solution consists of signal, coaxial and fiber optic contacts.

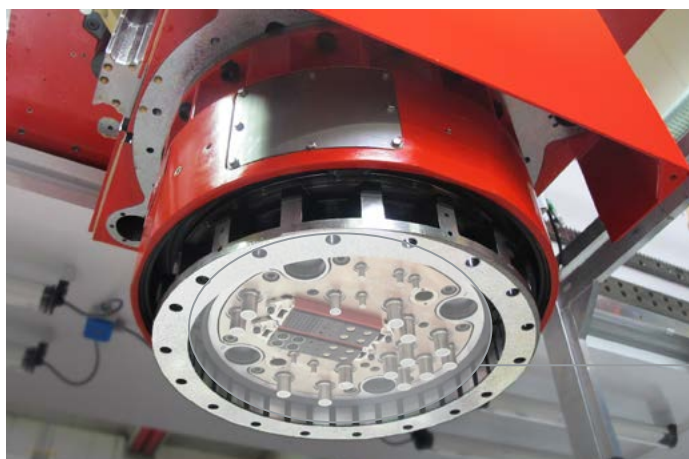
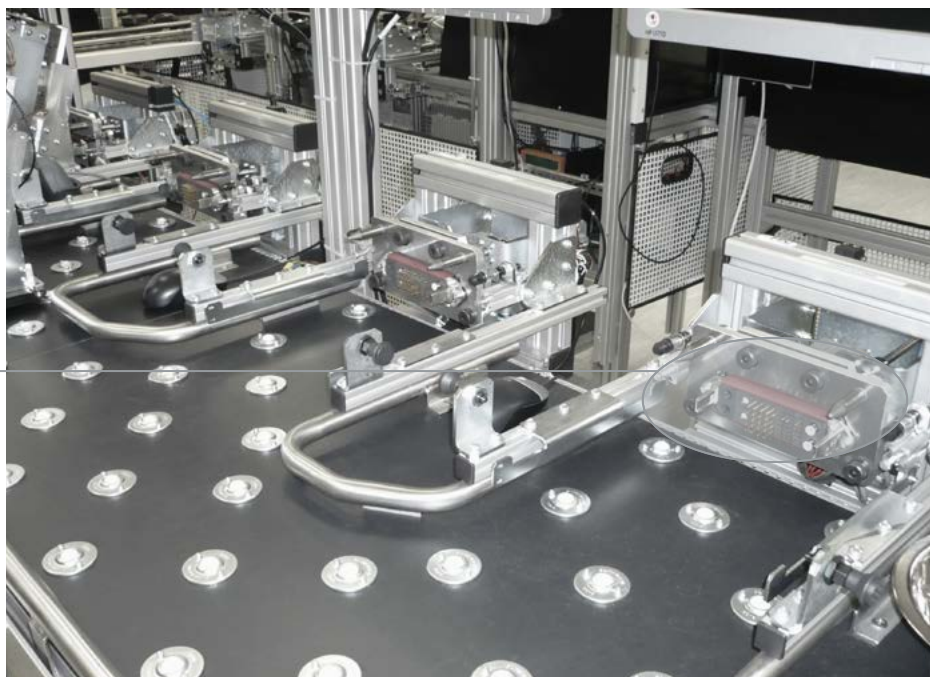

Connector solution with CombiTac for plate mounting, to create a connection between the various milling head units and the drive.

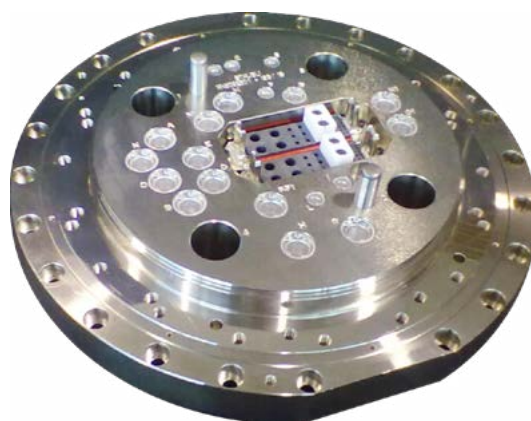



CombiTac in a modular test bench for the testing and simulation of electric components.



CombiTac for connections to mobile trolleys in operation rooms for medical technology.

CombiTac in Multi Coupling Systems (MCS)

The MCS principle allows you to centralize your different connections (power, signal, pneumatics, hydraulics, etc.) and get instant energy thanks to a much easier and reliable coupling procedure.

Such automatic or manually operated quick disconnect systems allow standard components to be mounted onto carrier plates and several energies to be connected or disconnected simultaneously.

MCS plates are commonly used in high-performance applications that demand reliability and repeatability, such as connections for test benches, injection moulding tools, transfer tables, and converters, etc.



MCS plates: the optimal combination of
high-performance solutions

UNLIMITED POSSIBILITIES FOR CONTACT SOLUTIONS

MULTILAM Technology

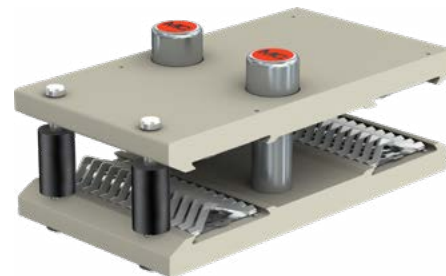

MULTILAM are specially formed and resilient contact elements. All Stäubli Electrical Connectors products benefit from the unique and outstanding performance of the **MULTILAM** Technology.

Thanks to their constant spring pressure, MULTILAM louvers ensure continuous contact with the contact surface, resulting in a constantly low contact resistance.

MULTILAM Technology allows to find solutions for connectors within the severest constraints and in certain products for up to 1 million mating cycles.

This makes the MULTILAM Technology the best choice for applications with demanding requirements:

- Reliable and longlife operation due to constantly high performance
- Safe operation under highest environmental demands on temperature, vibration and shock
- Suitable for data and signal contacts as well as high-current connectors
- Automated solutions with a high number of mating cycles



Index

| Type | Page |
|------------------|------|
| CT-10GBIT-M12/B | 45 |
| CT-10GBIT-M12/S | 45 |
| CT-10GBIT-RJ45/B | 45 |
| CT-10GBIT-RJ45/S | 45 |
| CT-AG1 | 82 |
| CT-AG1-D | 82 |
| CT-AG1 IP68 HE | 85 |
| CT-AG1-PS/B | 84 |
| CT-AG1-PS/S | 84 |
| CT-AG1 TP | 90 |
| CT-AG2 | 82 |
| CT-AG2-D | 82 |
| CT-AG2 IP68 HE | 85 |
| CT-AG2-PS/B | 84 |
| CT-AG2-PS/S | 84 |
| CT-AG2/PW | 82 |
| CT-AG2 TP | 90 |
| CT-AG2/ZV | 86 |
| CT-AG3 | 82 |
| CT-AG3-D | 82 |
| CT-AG3 IP68 HE | 85 |
| CT-AG3-PS/B | 84 |
| CT-AG3-PS/S | 84 |
| CT-AG3/PW | 82 |
| CT-AG3 TP | 90 |
| CT-AG3/ZV | 86 |
| CT-AG4 | 82 |
| CT-AG4-D | 82 |
| CT-AG4 IP68 HE | 85 |
| CT-AG4-PS/B | 84 |
| CT-AG4-PS/S | 84 |
| CT-AG4/PW | 82 |
| CT-AG4 TP | 90 |
| CT-AG4/ZV | 86 |
| CT-AG5 | 82 |
| CT-AG5-D | 82 |
| CT-AG5-PS/B | 84 |
| CT-AG5-PS/S | 84 |
| CT-AG5/PW | 82 |
| CT-AG6 | 82 |
| CT-AG6-D | 82 |
| CT-AG6-PS/B | 84 |
| CT-AG6-PS/S | 84 |
| CT-AIWZ/COAX | 101 |

| Type | Page |
|-------------------------|---------|
| CT-AIWZ/POF | 101 |
| CT-A-WZ0,6 | 102 |
| CT-AWZ/POF | 102 |
| CT-B0,6ET/LO AU | 35 |
| CT-B0,6ET/PCB AU | 35 |
| CT-B1,5LAV/PCB AU | 29 |
| CT-B1ET/PCB AU | 33 |
| CT-B1/PCB AU | 33 |
| CT-B3/PCB AU | 23 |
| CT-B6/M5A AG | 21 |
| CT-B6/M5 AG | 21 |
| CT-B6/M5A/PE AG | 19 |
| CT-B8/M6A AG | 17 |
| CT-B8/M6A AU | 17 |
| CT-B8/M6 AG | 17 |
| CT-B8/M6A/PE AG | 19 |
| CT-B8/M6 AU | 17 |
| CT-B8/M8A/PE-L AG | 14 |
| CT-B12/M10 AG | 10 |
| CT-B/COAX58 | 41 |
| CT-B/COAX59 | 41 |
| CT-B-COAX-RG58 | 39 |
| CT-B-COAX-RG316/U | 39 |
| CT-B-COAX-SMA | 39 |
| CT-BE-B | 68 |
| CT-BEG-B | 68 / 93 |
| CT-BEG-S | 68 / 93 |
| CT-BE-S | 68 |
| CT-BESZ-B | 68 |
| CT-BESZ-S | 68 |
| CT-B/GOF | 51 |
| CT-B/GOF-100-SC | 51 |
| CT-B/GOF-100-ST | 51 |
| CT-BP0,6ET/0,14-0,25 AU | 35 |
| CT-BP1/0,25-0,75 AU | 33 |
| CT-BP1,5LAV/0,5-1,5 AU | 29 / 55 |
| CT-BP1,5LAV/1,5 AU | 29 |
| CT-BP1ET/0,25-0,75 AU | 33 |
| CT-BP3/2,5-4 AU | 23 / 25 |
| CT-BP3/2,5-4/PE AU | 25 |
| CT-BP3/2,5-HV AU | 27 |
| CT-BP6/6 AG | 21 |
| CT-BP6/10 AG | 21 |
| CT-BP6/16 AG | 21 |

| Type | Page |
|------------------------|---------|
| CT-BP6/16/PE AG | 19 |
| CT-BP8/10 AG | 17 |
| CT-BP8/10 AU | 17 |
| CT-BP8/16 AG | 17 |
| CT-BP8/16 AU | 17 |
| CT-BP8/25 AG | 17 |
| CT-BP8/25 AU | 17 |
| CT-BP8/25/PE AG | 19 |
| CT-BP8/25/PE-L AG | 13 |
| CT-BP8/35 AG | 17 |
| CT-BP8/35/PE-L AG | 13 |
| CT-BP8/50/PE-L AG | 13 |
| CT-BP10/10/PE-GND AG | 95 |
| CT-BP10/16/PE-GND AG | 95 |
| CT-BP10/25/PE-GND AG | 95 |
| CT-BP10/35/PE-GND AG | 95 |
| CT-BP10/50/PE-GND AG | 95 |
| CT-BP10/AWG4/PE-GND AG | 95 |
| CT-BP12/50 AG | 9 |
| CT-BP12/70 AG | 9 |
| CT-BP12/95 AG | 9 |
| CT-B/POF | 49 |
| CT-B-RCT03/1/4" | 59 |
| CT-B-RCT03/4 | 59 |
| CT-B-RCT03/6 | 59 |
| CT-B-RCT03/PLV 2/4 | 59 |
| CT-B-RCT03/PLV4/6 | 59 |
| CT-BS | 68 |
| CT-BS1 | 33 |
| CT-BS8 | 17 / 41 |
| CT-B-SCT03 | 65 |
| CT-B-SCT05 | 67 |
| CT-BSGOF | 37 |
| CT-BTG-B | 68 |
| CT-BTG-S | 68 |
| CT-B-UCT04/1/4" | 59 |
| CT-B-UCT04/6 | 59 |
| CT-B-UCT06/8 | 61 |
| CT-B-UCT08/3/8" | 63 |
| CT-B-UCT08/10 | 63 |
| CT-BV-RCT03/1/4" | 59 |
| CT-BV-RCT03/4 | 59 |
| CT-BV-RCT03/6 | 59 |
| CT-BV-RCT03/PLV 2/4 | 59 |

| Type | Page |
|---------------------|-------------------|
| CT-BV-RCT03/PLV4/6 | 59 |
| CT-BV-RCT06/8 | 63 |
| CT-BV-RCT06/PLV6/8 | 63 |
| CT-BV-RCT06/PLV8/10 | 63 |
| CT-CN | 76 |
| CT-CZ/COAX | 101 |
| CT-CZ/POF | 101 |
| CT-DIP0,5 | 78 |
| CT-DIP1 | 78 |
| CT-DIP1,3-3,4 | 35 |
| CT-DIP2 | 78 |
| CT-DIP3 | 78 |
| CT-DIP4 | 78 |
| CT-DIP4/2 | 14 / 78 |
| CT-E0,6-20/B | 34 |
| CT-E0,6-20/S | 34 |
| CT-E1,5-5 | 28 |
| CT-E1-6 | 32 |
| CT-E1-15/B | 31 |
| CT-E1-15/S | 31 |
| CT-E1-26/B | 30 |
| CT-E1-26/S | 30 |
| CT-E-2TH+PE/B | 54 |
| CT-E-2TH+PE/S | 54 |
| CT-E3-1/HV-B | 26 |
| CT-E3-1/HV-S | 26 |
| CT-E3-2/HV-B | 26 |
| CT-E3-2/HV-S | 26 |
| CT-E3-2+PE | 24 |
| CT-E3-3 | 22 |
| CT-E3-3/PCB | 22 |
| CT-E-3POF/B | 48 |
| CT-E-3POF/S | 48 |
| CT-E-4GOF | 50 |
| CT-E6-2 | 20 / 48 |
| CT-E8-2 | 16 / 40 / 58 / 64 |
| CT-E8-2-IP2X | 16 |
| CT-E8-4/B | 58 / 64 |
| CT-E8-4/S | 58 / 64 |
| CT-E8/6-1 | 18 |
| CT-E8/6-PE | 12 / 18 |
| CT-E12-1/B | 8 |
| CT-E12-1/S | 8 |
| CT-E-COAX-1 | 38 |

| Type | Page |
|--------------------------|---------|
| CT-E-COAX-2 | 38 |
| CT-ELHB | 99 |
| CT-E-UCT06-1 | 60 |
| CT-E-UCT06-2 | 60 |
| CT-E-UCT06-4 | 60 |
| CT-E-UCT08-1 | 62 / 66 |
| CT-E-UCT08-2 | 62 / 66 |
| CT-E-WZ0,6 | 102 |
| CT-E-WZ1-9,5 | 102 |
| CT-E-ZV/B/TG2 | 86 |
| CT-E-ZV/B/TG3 | 86 |
| CT-E-ZV/B/TG4 | 86 |
| CT-E-ZV/S | 86 |
| CT-GND10 AG | 94 |
| CT-HV-SRTU | 27 |
| CT-KG1 | 80 |
| CT-KG2 | 80 |
| CT-KG3 | 80 |
| CT-KG4 | 80 |
| CT-KG5 | 80 |
| CT-KSCH6-35 | 17 / 19 |
| CT-K-SCH25-8 | 14 |
| CT-K-SCH35-8 | 14 |
| CT-K-SCH70-10 | 10 |
| CT-K-SCH95-10 | 10 |
| CT-K-VSH M25x9,5-12,5 MS | 11 |
| CT-K-VSH M25x10-17 MS | 11 |
| CT-K-VSH M25x16-20,5 MS | 11 |
| CT-K-VSH M32x14-17 MS | 11 |
| CT-K-VSH M32x17-21 MS | 11 |
| CT-K-VSH M32x21-25,5 MS | 11 |
| CT-K-WZ | 103 |
| CT-K-WZ-AFL | 103 |
| CT-LH4 | 99 |
| CT-LMFB/B | 36 |
| CT-LMFB-B2/0,5-1,5 AU | 37 |
| CT-LMFB/S | 36 |
| CT-LMFB-S2/0,5-1,5 AU | 37 |
| CT-M-CZ | 100 |
| CT-NET-1/B | 42 |
| CT-NET-1/S | 42 |
| CT-NET-2/B | 42 |
| CT-NET-2/S | 42 |
| CT-NET-AWZ | 102 |

| Type | Page |
|---------------------------|------|
| CT-NET-BP1ET/0,15-0,75 AU | 43 |
| CT-NET-BS | 43 |
| CT-NET-SP1/0,15-0,75 AU | 43 |
| CT-POF/SL | 49 |
| CT-PS/POF | 101 |
| CT-RC12 | 8 |
| CT-RC-COAX | 38 |
| CT-RJ45/B | 46 |
| CT-RJ45/S | 46 |
| CT-S0,6/LO AU | 35 |
| CT-S0,6/PCB AU | 35 |
| CT-S1,5/PCB-K AU | 29 |
| CT-S1,5/PCB-L AU | 29 |
| CT-S1/PCB-K AU | 33 |
| CT-S1/PCB-L AU | 33 |
| CT-S3/PCB-K AU | 23 |
| CT-S3/PCB-L AU | 23 |
| CT-S6/M5A AG | 21 |
| CT-S6/M5 AG | 21 |
| CT-S6/M5A/PE AG | 19 |
| CT-S8/M6A AG | 17 |
| CT-S8/M6A AU | 17 |
| CT-S8/M6 AG | 17 |
| CT-S8/M6A/PE AG | 19 |
| CT-S8/M6 AU | 17 |
| CT-S8/M8A/PE-L AG | 14 |
| CT-S12/M10 IP2X AG | 10 |
| CT-S/COAX58 | 41 |
| CT-S/COAX59 | 41 |
| CT-S-COAX-RG58 | 39 |
| CT-S-COAX-RG316/U | 39 |
| CT-S-COAX-SMA | 39 |
| CT-SD-AG1-L/FSCH | 84 |
| CT-SD-AG2-L/FSCH | 84 |
| CT-SD-AG3-L/FSCH | 84 |
| CT-SD-AG4-L/FSCH | 84 |
| CT-SD-AG5-L/FSCH | 84 |
| CT-SD-AG6-L/FSCH | 84 |
| CT-SD-TG1 TP | 91 |
| CT-SD-TG2 TP | 91 |
| CT-SD-TG3 TP | 91 |
| CT-SD-TG4 TP | 91 |
| CT-SG1-H | 83 |
| CT-SG1-H/D | 83 |

| Type | Page |
|-----------------------|---------|
| CT-SG1 IP68 HE | 86 |
| CT-SG1 TP | 91 |
| CT-SG2-H | 83 |
| CT-SG2-H/D | 83 |
| CT-SG2-H/PW | 83 |
| CT-SG2 IP68 HE | 86 |
| CT-SG2 TP | 91 |
| CT-SG3-H | 83 |
| CT-SG3-H/D | 83 |
| CT-SG3-H/PW | 83 |
| CT-SG3 IP68 HE | 86 |
| CT-SG3 TP | 91 |
| CT-SG4-H | 83 |
| CT-SG4-H/D | 83 |
| CT-SG4-H/PW | 83 |
| CT-SG4 IP68 HE | 86 |
| CT-SG4 TP | 91 |
| CT-SG5-H | 83 |
| CT-SG5-H/D | 83 |
| CT-SG5-H/PW | 83 |
| CT-SG6-H | 83 |
| CT-SG6-H/D | 83 |
| CT-S/GOF | 51 |
| CT-S/GOF-100-SC | 51 |
| CT-S/GOF-100-ST | 51 |
| CT-SP0,6/0,14-0,25 AU | 35 |
| CT-SP1/0,25-0,75K AU | 33 |
| CT-SP1/0,25-0,75L AU | 33 |
| CT-SP1,5/0,5-1,5K AU | 29 / 55 |
| CT-SP1,5/0,5-1,5L AU | 29 |
| CT-SP1,5/1,5K AU | 29 |
| CT-SP3/2,5-4K AU | 23 / 25 |
| CT-SP3/2,5-4L AU | 23 / 25 |
| CT-SP3/2,5-4/PE AU | 25 |
| CT-SP3/2,5-HV AU | 27 |
| CT-SP6/6 AG | 21 |
| CT-SP6/10 AG | 21 |
| CT-SP6/16 AG | 21 |
| CT-SP6/16/PE AG | 19 |
| CT-SP8/10 AG | 17 |
| CT-SP8/10 AU | 17 |
| CT-SP8/16 AG | 17 |
| CT-SP8/16 AU | 17 |
| CT-SP8/25 AG | 17 |

| Type | Page |
|------------------------|------|
| CT-SP8/25 AU | 17 |
| CT-SP8/25/PE AG | 19 |
| CT-SP8/25/PE-L AG | 13 |
| CT-SP8/35 AG | 17 |
| CT-SP8/35/PE-L AG | 13 |
| CT-SP8/50/PE-L AG | 13 |
| CT-SP10/10/PE-GND AG | 95 |
| CT-SP10/16/PE-GND AG | 95 |
| CT-SP10/25/PE-GND AG | 95 |
| CT-SP10/35/PE-GND AG | 95 |
| CT-SP10/50/PE-GND AG | 95 |
| CT-SP10/AWG4/PE-GND AG | 95 |
| CT-SP12/50 IP2X AG | 9 |
| CT-SP12/70 IP2X AG | 9 |
| CT-SP12/95 IP2X AG | 9 |
| CT-S/POF | 49 |
| CT-S-RCT03/¼“ | 59 |
| CT-S-RCT03/4 | 59 |
| CT-S-RCT03/6 | 59 |
| CT-S-RCT03/PLV 2/4 | 59 |
| CT-S-RCT03/PLV4/6 | 59 |
| CT-S-RCT06/8 | 63 |
| CT-S-RCT06/PLV6/8 | 63 |
| CT-S-RCT06/PLV8/10 | 63 |
| CT-S-SCT03 | 65 |
| CT-S-SCT05 | 67 |
| CT-S-UCT04/¼“ | 59 |
| CT-S-UCT04/6 | 59 |
| CT-S-UCT06/8 | 61 |
| CT-S-UCT08/3/8“ | 63 |
| CT-S-UCT08/10 | 63 |
| CT-TG1-G | 80 |
| CT-TG1-G IP68 HE | 85 |
| CT-TG1-G TP | 90 |
| CT-TG1-S | 80 |
| CT-TG1-S IP68 HE | 85 |
| CT-TG1-S TP | 90 |
| CT-TG2-G | 80 |
| CT-TG2-G IP68 HE | 85 |
| CT-TG2-G/PW | 81 |
| CT-TG2-G/PW-D | 81 |
| CT-TG2-G TP | 90 |
| CT-TG2-S | 80 |
| CT-TG2-S IP68 HE | 85 |

| Type | Page |
|------------------|------|
| CT-TG2-S/PW | 81 |
| CT-TG2-S/PW-D | 81 |
| CT-TG2-S TP | 90 |
| CT-TG2/ZV | 86 |
| CT-TG3-G | 80 |
| CT-TG3-G IP68 HE | 85 |
| CT-TG3-G/PW | 81 |
| CT-TG3-G/PW-D | 81 |
| CT-TG3-G TP | 90 |
| CT-TG3-S | 80 |
| CT-TG3-S IP68 HE | 85 |
| CT-TG3-S/PW | 81 |
| CT-TG3-S/PW-D | 81 |
| CT-TG3-S TP | 90 |
| CT-TG3/ZV | 86 |
| CT-TG4-G | 80 |
| CT-TG4-G IP68 HE | 85 |
| CT-TG4-G/PW | 81 |
| CT-TG4-G/PW-D | 81 |
| CT-TG4-G TP | 90 |
| CT-TG4-S | 80 |
| CT-TG4-S IP68 HE | 85 |
| CT-TG4-S/PW | 81 |
| CT-TG4-S/PW-D | 81 |
| CT-TG4-S TP | 90 |
| CT-TG4/ZV | 86 |
| CT-TG5-G | 80 |
| CT-TG5-G/PW | 81 |
| CT-TG5-G/PW-D | 81 |
| CT-TG5-S | 80 |
| CT-TG5-S/PW | 81 |
| CT-TG5-S/PW-D | 81 |
| CT-TG6-G | 80 |
| CT-TG6-G/PW | 81 |
| CT-TG6-G/PW-D | 81 |
| CT-TG6-S | 80 |
| CT-TG6-S/PW | 81 |
| CT-TG6-S/PW-D | 81 |
| CT-ZV/B | 86 |
| DBP2-AL/0,14-0,5 | 55 |
| DBP2-CO/0,14-0,5 | 55 |
| DBP2-CR/0,14-0,5 | 55 |
| DBP2-CU/0,14-0,5 | 55 |
| DBP2-FE/0,14-0,5 | 55 |

| Type | Page |
|----------------------|------|
| DBP2-NICRSI/0,14-0,5 | 55 |
| DBP2-NISI/0,14-0,5 | 55 |
| DSP2-AL/0,14-0,5 | 55 |
| DSP2-CO/0,14-0,5 | 55 |
| DSP2-CR/0,14-0,5 | 55 |
| DSP2-CU/0,14-0,5 | 55 |
| DSP2-FE/0,14-0,5 | 55 |
| DSP2-NICRSI/0,14-0,5 | 55 |
| DSP2-NISI/0,14-0,5 | 55 |
| F/M8 DIN6798A BN781 | 14 |
| F/M10 DIN6798A BN781 | 10 |
| K-SCH50-8 | 14 |
| K-SCH50-10 | 10 |
| LI-BL-SHR | 68 |
| LI-KM-SHR | 68 |
| MALU-PZ13 | 100 |
| MBA-WZ1/1,2 | 102 |
| MBA-WZ1,5 | 102 |
| MBA-WZ3 | 102 |
| MBA-WZ5 | 102 |
| MBA-WZ6 | 102 |
| MES-CZ | 100 |
| MES-CZ-CT 0,6 | 100 |
| MES-CZ-CT0,6-COAX-RG | 100 |
| MES-CZ-CT1 | 100 |
| MES-CZ-CT1,5 | 100 |
| MES-CZ-CT3 | 100 |
| MES-PZ-TB5/6 | 100 |
| MES-PZ-TB 8/10 | 100 |
| MES-PZ-TB 9/16 | 100 |
| MES-PZ-TB11/25 | 100 |
| ME-WZ1,5/2 | 102 |
| ME-WZ3 | 102 |
| ME-WZ5 | 102 |
| ME-WZ6 | 102 |
| MPS-PZ13 | 100 |
| M-PZ13 | 100 |
| M-PZ-T2600 | 100 |
| MSA-WZ1/1,2 | 102 |
| MSA-WZ1,5 | 102 |
| MSA-WZ3 | 102 |
| MSA-WZ5 | 102 |
| MSA-WZ6 | 102 |
| MSA-WZ8 | 102 |

| Type | Page |
|--------------|---------|
| MU0,8D/M8 AG | 14 |
| MVS1 | 29 |
| MVS1,5/2 | 55 |
| MVS3 | 23 / 25 |
| MVS5 | 21 |
| TB7-20 | 100 |
| TB8-17 | 100 |
| TB9-13 | 100 |

| Type | Page |
|-------------------------------------|------|
| TB11-14,5 | 100 |
| U/M8 AG | 14 |
| U/M10 AG | 10 |
| ZYL-SHR-IN-6KT M10×20 ISO4762 BN610 | 10 |



■ Stäubli Units ○ Agents

Global presence of the Stäubli Group

www.staubli.com