



European leader in piezoceramic audible components

Buzzers & Transducers



STANDARD SERIES / SMA-SERIES / SMAT-SERIES / SMB-SERIES

Alarms & Sirens



SAS-SERIES / SAP-SERIES / SMAC-SERIES / SXL-SERIES / SDS-SERIES

Piezoceramic Speakers & Amplifiers

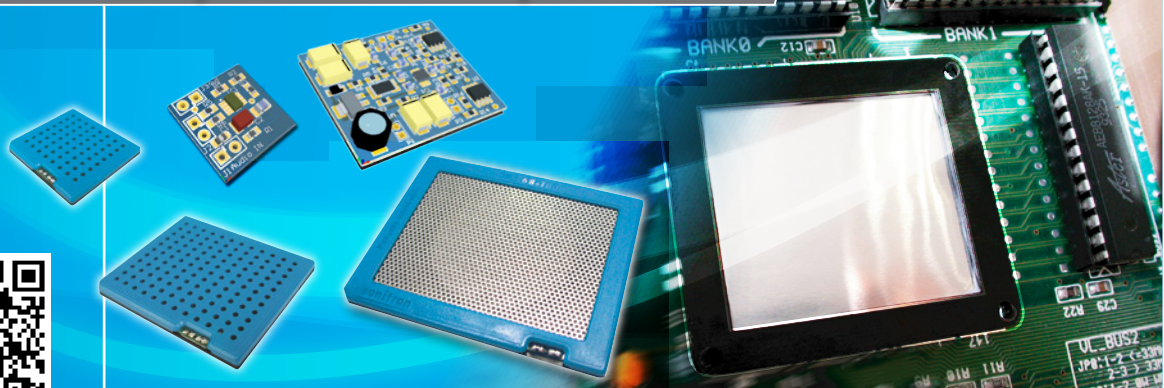

SCS-SERIES / SPS-SERIES / Blue Line SPS SERIES / PAA-SERIES



INTRODUCTION

Our company became the European leader in PIEZO CERAMIC acoustic components. Today we release several new products such as PIEZO SPEAKERS, AMPLIFIERS, THE FIRST PIEZO CAR-HORN and adapted alarms for the automotive industry!

We are convinced that these new products will realise a significant contribution in the modern technology evolution and will lead to new applications in CARS, TRUCKS, TRAINS, BOATS and any type of vehicle and transport device.

This catalogue describes the three different piezoceramic audible product families.

Buzzers & transducers

They have unlimited applications, and are panel and PCB mountable. The standard series operate in harsh weather conditions and are waterproof, shockproof and gasproof. They are very reliable in critical applications. The SMA series are low cost commercial grade components PCB mountable, available in buzzer and transducer version. Top quality materials and elaborated working principals guarantees high quality products at economic cost.

Alarms & sirens

A range of waterproof and IP67 rating sirens and alarms generates an acoustic warning signal in critical environmental situations. They are especially designed to function from -40°C to +80°C offering an high life time in continuous operation. A new series of automotive car horns are available for advanced applications.

Speakers and amplifiers

These brand new flat piezo speakers and amplifiers are low weight, solid-state, low distortion with extremely small current drain. This new generation of piezo speakers can be driven by several audio amplifiers recently introduced on the integrated circuits market. Demonstration units are at your disposal for deeper evaluation of this technology in multi media and portable devices. Our on-line support team is assisting you with the design-in of this advanced piezo technology.

We refer to our website: <http://www.sonitron.be>

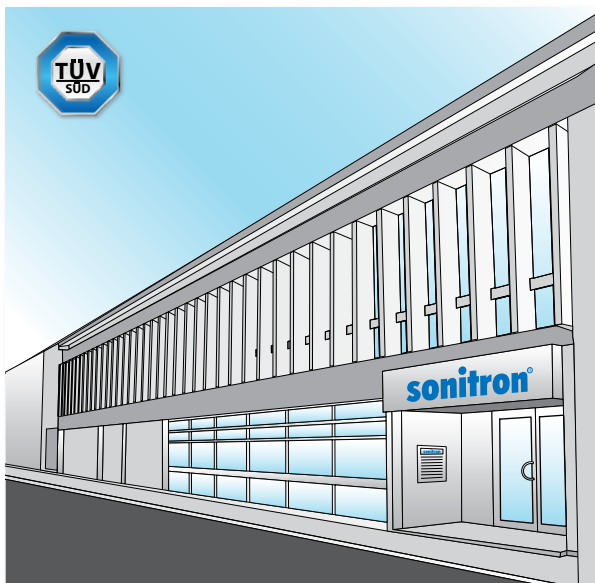

sonitron® n.v.
Kasteelstraat 93
9100 Sint-Niklaas
BELGIUM
Tel.: 32 3 780 76 30
Fax.: 32 3 777 58 96
sales@sonitron.be
info@sonitron.be
<http://www.sonitron.be>
<http://www.sonitron.eu>

Hugo R. Michiels
President and CEO



CONTENTS

	Introduction	2
	Company organisation	8
	Models on request	9
	Certificates	10, 11
	Know-how & Equipment	12, 13
	Application fields	14, 15, 16
	Product selection guide	17

Buzzers & Transducers

Key questions for product determination	19
---	----



STANDARD SERIES

Introduction	21
Advantages and applications	21
Specifications	22
Specials	22
Multi-functionality of the standard series	23
Selection guide	23
Electrical parameters	24, 25
Dimensions	26, 27
Product options standard series	28
Mounting guidelines	28, 29
Product codification	30
List of available product types	30
Military models	31, 32
Models on request	33
Packaging	33



STANDARD SVC SERIES

Introduction	34
Advantages and applications	34
Specifications	34
Electrical parameters	35
Dimensions	35
List of available product types	35



STANDARD SRA SERIES

Introduction	36
Advantages and applications	36
Specifications	36

Electrical parameters	37
Dimensions	37
List of available product types	37



FOAM PATCH OPTION - FP 38

Introduction	38
Advantages and applications	38
Available foam patches	39

MULTI-APPLICATION SERIES (SMA, SMAT) 40

Introduction	40
Selection guide	41



SMA SERIES (Buzzers) 42

Advantages and applications	42
Specifications	42,43
Electrical parameters	43,44
Product codification	45
List of available product types	45



SMAT SERIES (Transducers) 46

Advantages & Applications	46
Specifications	46
Electrical parameters	47
Drive circuits	47
Product codification	48
List of available product types	49
Dimensions	50,51
Mounting possibilities for the SMA & SMAT-Series	52
Order options for the SMA & SMAT-Series	52
Packaging SMA & SMAT-Series	53



MULTI-FREQUENCY BUZZERS (SMB) 54

Introduction	54
Advantages & Applications	54
Specifications	55
Electrical parameters	55,56
Dimensions	57
Working principle	58
Typical application description	58
Product codification	59
List of available product types	59
Packaging	59

Alarms & Sirens



60

Key questions for product determination	61
General overview Alarms & Sirens	62



SAP-SERIES

63

SAP-1302-A/B/C/D

Advantages & Applications	63
Specifications	64,65
List of available product types	66
Dimensions	66
Mounting guidelines	66

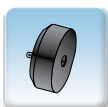

SAS-SERIES

67

Introduction	67
Advantages & Applications	67

SAS-2155-S / SAST-2155

Specifications	68
Electrical parameters	68
Dimensions	70
Product options	72
Product codification	72
List of available product types	72



SMAC-SERIES

73

Advantages & Applications	73
Specifications	73
Electrical parameters	74
Dimensions	74
Product codification	75
List of available product types	75
Product options	75
Packaging	75



SXL-SERIES

76

Advantages & Applications	76
Specifications	76
Electrical parameters	77
Dimensions	77,78
Product codification	78
List of available product types	78



SDS-SERIES

79

Introduction	79,80,81,82
Dimensions	82

Piezoceramic Speakers & Piezo Audio Amplifiers  83

Key questions for product determination	84
General overview SCS / SPS / Blue line SPS series PAA	85



SCS-SERIES	86
Introduction	86
General overview SCS-series	87
Advantages & Applications	87
Specifications	88
Impedance	88
Frequency response	89
Dimensions	90,91
Product options	91
Recommended piezo audio amplifiers	91
Product codification	92
List of available product types	92
Packaging	92
Acoustic mounting instructions for SCS-speakers	93

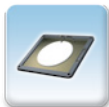

SPS-SERIES	94
Introduction	94
Advantages & Applications	95
Specifications	95
Impedance	95,96

SPS-2220-03	
Specifications	97
Frequency response	97
Dimensions	98
Recommended piezo audio amplifiers	98

SPS-3530-03	
Specifications	99
Frequency response	99
Dimensions	100
Recommended piezo audio amplifiers	100

SPS-4640-03	
Specifications	101
Frequency response	101
Dimensions	102
Recommended piezo audio amplifiers	102

SPS-6555-03	
Specifications	103
Frequency response	103
Dimensions	104
Recommended piezo audio amplifiers	104

SPS-8770-03	
Specifications	105
Frequency response	105

Dimensions	106
Recommended piezo audio amplifiers	106
Product codification	107
List of available product types	107
Packaging	107
Acoustic mounting instructions for SPS-speakers	108,109
Fundamental acoustic mounting recommendations	110

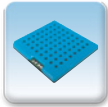

Blue Line SPS Series

Introduction	112
Advantages & Applications	112
Specifications	112
Power consumption	113
Frequency response	114
Dimensions	115,116
Mounting guidelines	117
Product options	118
Product codification	119
List of available product types	119
Packaging	119
Recommended Piezo Audio Amplifiers	120

PIEZO AUDIO AMPLIFIERS



Introduction	122
General overview PAA series	122
Basics of piezo audio amplifiers	123
PAA-LT3469-01	123
PAA-MAX9788-01	123
PAA-LM4960SQ-02	124
PAA-StepUpBTL-01	124
Additional information	125
Demonstration unit DU6597	125
Presentation examples	125,126
Blind power dissipation	126
The importance of the isolation resistor	127
Automatic speaker / microphone switch	128,129

ADDENDUM



Special product options	131,132,133
Considerations about sound	134,135
Harmonic	136
Fourier	136
Harmonic content of a square wave	137
RMS and average power	137
Expected life time	138,139
Soldering instructions	140,141,142
Critical components	143
Warranty and delivery conditions	143
IP ratings	144
Distributors & Representatives	145,146,147

COMPANY ORGANISATION

Sonitron is a specialized manufacturing company, with total in-house capabilities, and headquartered in Belgium. Our worldwide customers are located in Europe, USA and Asia. Sonitron's products are distributed and sold through an international network of distributors and representatives.

They give excellent sales and technical service and provide our customers with price quotations, samples, catalogues, technical assistance,...

Please check the distributors and representatives list (page 145-147) to look for your nearest contact person or visit our website for updated information about our worldwide distribution network. <http://www.sonitron.be>

However, if there is no distributor or representative in your country or should you require more detailed information, do not hesitate to contact our headquarter in Belgium.

Send your request to sales@sonitron.be or info@sonitron.be and we will be pleased to help you further!

Sonitron has the following departments to assist you...

**Total
in-house
capability**

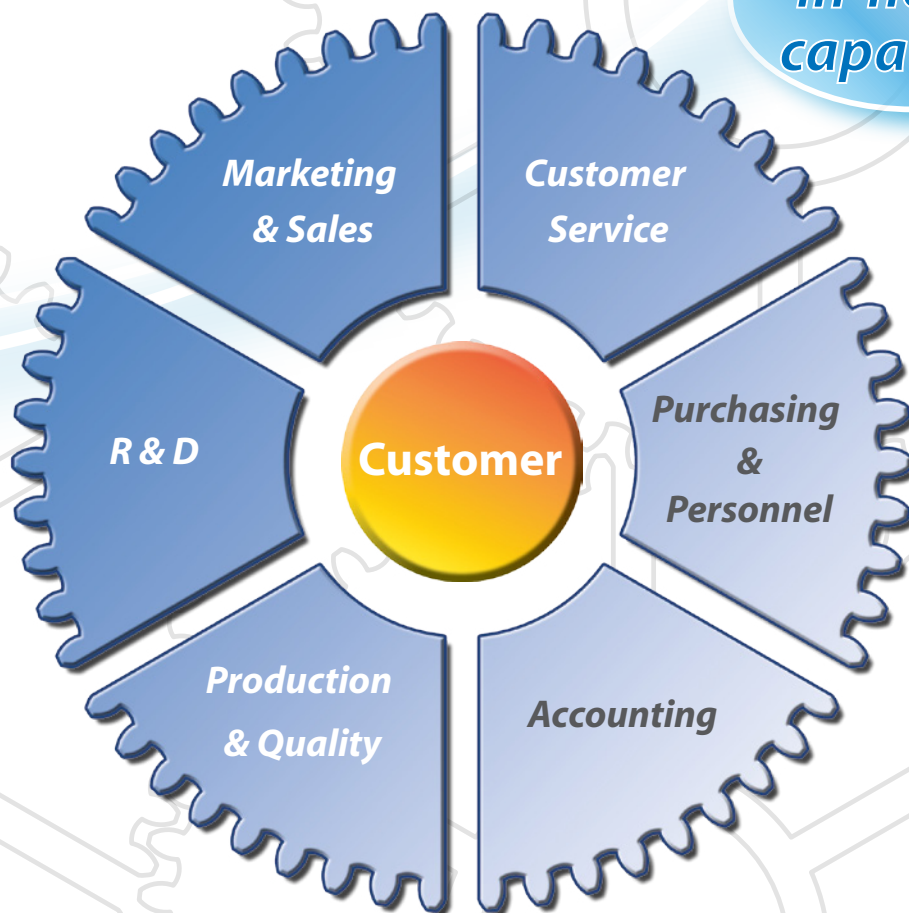

The first issue of the catalogue was published in August 1977 and was completed and improved every two years with new principles, models and applications.

Copies and reproductions are not allowed without the written agreement of the author Hugo Remi MICHIELS, president of SONITRON N.V.

MODELS ON REQUEST

Continuous research, intensive development and specialist know-how have resulted in a wide range of high quality and reliable products, from the smallest and most cost effective buzzer to highly sophisticated alarms. This allows Sonitron to meet the needs of many different applications within the industrial, consumer, medical and military industry.

Ongoing investments in the in-house disciplines enables Sonitron to maintain their market reputation and being your first choice supplier of audible components and application support in acoustic technology.

Our future activities will be focused not only on research and development of new applications and products, but also on the development of buzzers or speakers for special customer requests. Our engineers will carefully study your application and give their support for the realisation of your audio-project with Sonitron products.

**Please send your request for Technical Support to sales@keiconn.com.
We will be pleased to assist you!**



CERTIFICATES

The Certification Body
of TÜV SÜD Management Service GmbH
certifies that:

Sonitron N.V.
Kasteelstraat 93
B - 9100 Sint-Niklaas



CERTIFICATE



Management Service

Has established and applies
a Quality Management System for:

Sales, design and production in Physics and Electronics regarding acoustic components

Management system as per
ISO 9001 : 2008



Hugo R. Michiels
President and CEO
SONITRON N.V.



Sonitron sound components that can be used by customers as an independent product are subjected to the European CE legislation. Sound components which are designed to be placed on a PCB board are not subjected to the CE legislation.

The Sonitron sound components with CE label are in accordance with the following CE directives.

2011/65/EU RoHS2 Directive

Concerning the restriction of the use of certain hazardous substances in electrical and electronic equipment

2004/108/EC EMC Directive

Measurements according following standard(s) :

EN50130-4: 1995/ A1:1998 /A2:2003 (Alarms)

- EN61000-4-3 – Radiated immunity
- EN61000-4-6 – Conducted immunity
- EN61000-4-2 – Electrostatic discharges
- EN61000-4-4 – Electrical fast transient
- EN61000-4-5 – Electrical surges

EN61000-6-3 (2006)

- EN 55011 - Radiated emission
- EN 55011 - Conducted emission

Remarks: The tested modules components can't be connected to cables longer or equal to 30m as is specified in EN50130-4 for testing according EN61000-4-5.

RoHS and RoHS2 (RESTRICTION OF HAZARDOUS SUBSTANCES)

I herewith declare that as from october 1, 2005, all of our products are in compliance with the directive 2002/95/EC (restricting hazardous materials).

All components are even in accordance with the new 2011/65/EU ROHS 2 Directive although some products are not subjected to this European CE legislation.

We confirm that none of our buzzers (SMA, SMAT, SMAC, panel/Standard series, SRA, SVC), speakers (SCS and SPS series, Blue line series) or alarms (SAS, SAP series) contain any of the following substances: mercury (Hg) , cadmium (Cd), hexavalent chromium (Cr (VI)), polybrominated biphenyls (PBB), polybrominated diphenyl ethers (PBDE), lead.

Sonitron N.V. cannot be held responsible for any deviations in raw materials or components used in their products.

Additional information or reports can be supplied after written and motivated request, provided it does not concern classified unreleased production information and subject to cost calculation when information is requested from third parties.

REACH Statement.

REACH



June 1st 2007 , REACH, the new European Community Regulation on chemicals and their safe use entered into law. The main objective of REACH is to improve the protection of the environment and human health, by registration and identification of chemicals in products and derivatives.

Sonitron NV identified as `Downstream User` will closely monitor the nature of any substance used inside or during the production of our products.

Sonitron NV declares it will notify, and inform its customers and distributors if an article contains more than 0.1% (weight per article) of any substances of the SVHC candidate list.
Date: 31/01/2009.

SVHC 151 update

Registration, Evaluation, Authorization, and restriction of Chemicals (EC 1907/2006).

Date: 16/12/2013

Conflict Minerals.

Sonitron is aware of Section 1502 "Conflict Minerals" of the Dodd-Frank Wall Street Reform and Consumer Protection Act and will comply with all reporting requirements.

Sonitron, confirms that none of the sound components manufactured by Sonitron NV contains any of the Conflict Minerals described as Tantalum (Ta), Tin (Sn), Tungsten (W) and gold (Au) or their derivatives sourced from the Democratic Republic of Congo or adjoining countries.

Sonitron N.V. cannot be held responsible for any deviations in raw materials or components used in their products.

Date: 30/09/2013



Hugo R. Michiels
President and CEO
SONITRON N.V.

KNOW-HOW AND EQUIPMENT

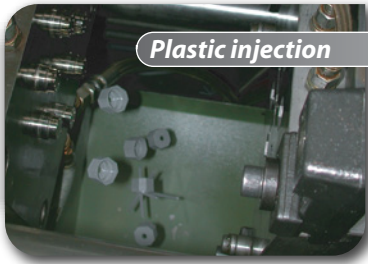

Plastic injection

Sonitron studied the use of numerous plastic materials for buzzer housings, resulting in the use of the highest quality materials. Sonitron has a fully automated plastic injection department, which guarantees full of all the dimensions and acoustic properties of the housings of our products.

Sonitron develop and produce themselves the mouldings for the plastic housings and pin terminals used in their buzzers. This in-house knowledge and expertise in moulding technology enables Sonitron to manufacture customized products.

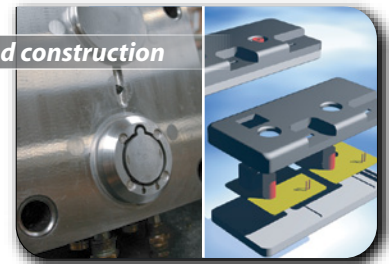

Mould development and construction



CNC milling machine

The fully automatic Milling Station with 5 axis is used to create new prototypes and plastic injection moulds. A continuous milling productivity is guaranteed due to the 16 load tool exchanger.

Sonitron develop specially shaped and formed membranes for use in their products. These membranes are produced in-house, enabling to maintain the high quality in large quantities, required for mass production of membranes with specific resonant frequencies.

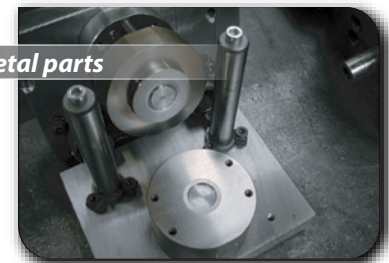

Pressing and cutting metal parts



Pick & place machine

The electronic circuits produced and incorporated in Sonitron's acoustic components are designed in-house and are fully automatically realised with the latest surface mount and soldering equipment.

As the process of gluing the ceramic onto the membrane is of essential importance for the reproduction of the requested frequency, Sonitron developed special gluing equipment. This equipment enables full control of perfect adhesion between the piezo disc and the membrane.

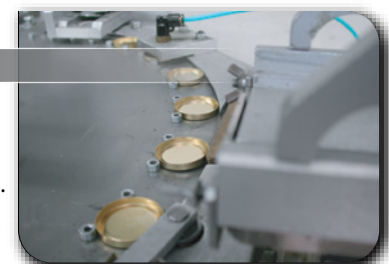

Automatic gluing

KNOW-HOW AND EQUIPMENT

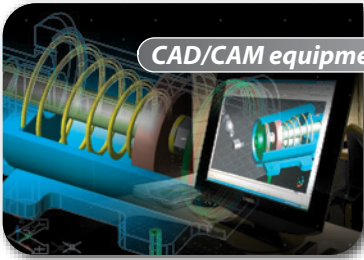

CAD/CAM equipment

The latest software programs and computing technologies are used for the in-house 3D-design of PC-boards, metal parts, moulds and automation equipment.



Electronic discharge machine (EDM)

The electronic discharge machine makes it possible to create very complex shapes. With this equipment, Sonitron is able to construct the moulds for special designs.

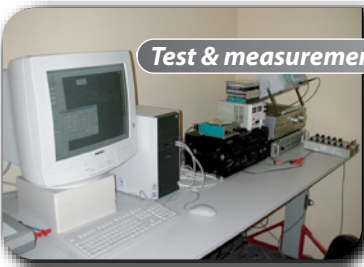

Test & measurement equipment

The anechoic room provides acoustic isolation from all background noises. The real time audio analyser can measure each type individually for frequency response, harmonic distortion and phase shift. All parameters such as dB(A), frequency, supply voltage are programmable. A printed copy of specific measurement reports is obtainable upon request.



Final quality control

Final testing of Sonitron's products is done in a special pyramid shaped sound absorption environment, avoiding reflection and standing wave patterns. This method guarantees very accurate SPL measurements.

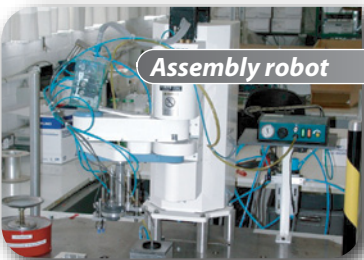

Assembly robot

This multifunctional programmable assembling robot is ideal for automation of Sonitron's production.



Ultrasonic equipment

This equipment is used for ultrasonic gluing of plastic parts to obtain very strong watertight sealing.

TYPICAL APPLICATION FIELDS



APPLICATION FIELDS

ACCESS CONTROL
 ADVERTISING MESSAGE EQUIPMENT
 AGRICULTURAL EQUIPMENT
 AIRCRAFTS
 ALARMS
 AMBULANCE SIREN
 ANSWERING MACHINE
 ASSEMBLING EQUIPMENT
 AUTOMATIC DOORS
 AUTOMATIC GUIDED VEHICLES
 AUTOMATION EQUIPMENT
 AUTOMOBILES
 BAGGAGE CLAIM ALARM
 BATTERY LOADERS
 BATTERY OPERATING BUZZERS
 BICYCLES
 BIO-FEEDING PUMPS
 BOAT ENGINE ALARM
 BOATS
 BUS
 CABLE TESTER
 CAMERA
 CAMERA SURVEYANCE
 CAR SPEAKERS
 CARD READER SYSTEMS
 CAR-WASH
 CASH REGISTERS
 CENTRAL HEATING CONTROL PANELS
 CLEANING MACHINES
 CLOCKS
 COCKPIT ALARM
 CODIFICATION SYSTEM
 COIN-TESTER
 COMMUNICATION EQUIPMENT
 COMPUTER EQUIPMENT
 CONSTRUCTION MACHINES
 CONSUMER ELECTRONICS
 CONTROL EQUIPMENT
 CONTROL PANEL
 CONTROL STATION
 COOLING MACHINES
 COPIERS

DASHBOARD
 DIGITAL SPEECH PROCESSING
 DIVING EQUIPMENT
 DOOR ACCESS
 DOOR LOCK ALARM
 DOORBELL
 ELECTRONIC GAMBLING MACHINE
 ELECTRONIC PORTABLE EQUIPMENT
 ELECTRONIC TIMERS
 ELEVATORS
 EMBARKATION DEVICE
 EMERGENCY STOP
 ENTERTAINMENT SYSTEM
 EVENT ALARM
 FIRE ALARM
 FIRE DETECTORS
 FISH FINDER
 FORKLIFT
 GAMES AND TOYS
 GAS DETECTORS
 GAS SENSOR
 GAS STATION
 GOLF CARTS
 HAND HELD COMPUTER
 HEATERS
 HELMETS
 HIGH PRESSURE CLEANERS
 HIGHWAY TOLL CARD SYSTEM
 HOISTING CRANE ALARM
 HOME EQUIPMENT & DOMOTICS
 HOME SPEAKERS
 HOOTER FOR BLIND PEOPLE
 HOSPITAL MESSAGE SYSTEM
 HOUSEHOLD EQUIPMENT
 INDUSTRIAL EQUIPMENT
 INDUSTRIAL WASHING MACHINES
 INSTRUMENTATION
 INTERCOM SYSTEMS
 KEYBOARD
 KEYPAD
 LANDING GEAR
 MEASUREMENT EQUIPMENT

APPLICATION FIELDS

MEDICAL EQUIPMENT
 MESSAGE RECORDING
 METAL DETECTOR GATE
 METAL DETECTORS
 METRO DOORS
 MICROPROCESSOR DEVICE
 MILITARY EQUIPMENT
 MILITARY RADIO
 MILITARY VEHICLE
 MINING EQUIPMENT
 MOBILE DATA COMMUNICATION
 MOBILE PHONE
 MONITORING & TEST EQUIPMENT
 MOTOR CONTROL
 MOTORCYCLES
 MOVING STAIRCASE
 MOWING-MACHINE
 MRI DEVICE
 MULTI-MEDIA EQUIPMENT
 NAVIGATION SYSTEM
 NOISE CANCELLATION UNIT
 NURSE CALL SYSTEM
 OFFICE EQUIPMENT
 PASSENGER INFORMATION SYSTEM
 PC MOTHERBOARD
 PET PUMP
 PETROL STATION
 PIPELINE MONITORING
 PORTABLE ANALYSERS
 POWER SUPPLY
 PRINTERS
 PROCESS CONTROL
 PROJECTOR
 PUBLIC MESSAGE SYSTEMS
 PUBLIC TELEPHONES
 PUMP STATIONS
 PUMP STEERING
 RADAR CONTROL DEVICE
 RADIO
 RAILWAY DOOR SYSTEM
 REMOTE CONTROL
 RESEARCH EQUIPMENT

RESPIRATOR
 RUNWAY LIGHTING
 SAFETY SYSTEMS
 SATELLITE SYSTEM
 SECURITY DEVICES
 SECURITY GATES (WALK THROUGH)
 SECURITY SYSTEMS
 SIGNAL EQUIPMENT
 SIGNALIZATION & PROCESS CONTROL EQUIPMENT
 SIGNALIZATION STICK FOR BLIND PEOPLE
 SOLAR PANELS AND SOLAR TRACKING SYSTEM
 SOLAR POWERED EMERGENCY PHONE
 SOLID STATE TIMER
 SUPERSONIC RECEIVER
 SURROUND STEREO SPEAKERS
 SURVEYANCE EQUIPMENT
 SWITCH BOARD
 TALKING BUZZER
 TELECOMMUNICATION
 TELEMETRY
 TELEPHONE EQUIPMENT
 TEST EQUIPMENT
 TICKET AUTOMAT
 TIMERS
 TOWER WAGGON
 TRACTORS
 TRAFFIC EQUIPMENT
 TRAINS
 TRANSMISSION SYSTEMS
 TRANSPONDER
 TRUCKS
 TV/HIFI MONITOR
 ULTRASONIC LEVEL DETECTION
 UNDERGROUND
 UTILITY METERS
 VEHICLE ACCESS CONTROL
 VENDING-MACHINES
 VENTILATOR
 VIDEO CONFERENCE SYSTEMS
 WEATHER CONTROL STATION
 WEIGHING EQUIPMENT
 WHEEL LOADER

sonitron® PRODUCT SELECTION GUIDE

BUZZERS & TRANSDUCERS

STANDARD SERIES >



Dimensions overview
(in mm)



STANDARD SVC SERIES >



STANDARD SRA SERIES >



SMA SERIES >

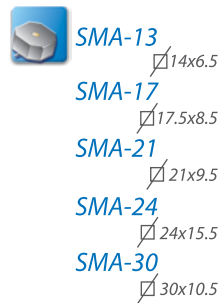

SMAT SERIES >



SMB SERIES >



ALARMS & SIRENS

SAP SERIES



Dimensions overview
(in mm)

$\phi \times H$
SAP-1302-A
SAP-1302-B
SAP-1302-C
SAP-1302-D
118.5 x 89
x 34.5

SAS SERIES >

SAS-2155-S
SAST-2155



$\phi 54 \times 19.6$

SMAC SERIES >



SMAC-25 $\phi 26.5 \times 18$

SMACI-25 $\phi 26.5 \times 18$

STANDARD SXL SERIES >



Round $\phi 36.5 \times 26$
Square $\sphericalangle 38 \times 26$

SXLC 515 C
SXLI 515 C1
SXLW 515 C
SXL P 515 C

SDS SERIES >



PIEZOCERAMIC SPEAKERS

SCS SERIES >



Dimensions overview
(in mm)

$\sphericalangle \times H$
SCS-17 $\sphericalangle 18.6 \times 9.7$
SCS-24 $\sphericalangle 25 \times 9.7$
SCS-32 $\sphericalangle 33.5 \times 9.7$

SPS SERIES >

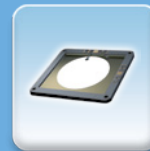

SPS-2220-03 20x22x1
SPS-3530-03 43.5x39x2
SPS-4640-03 50x43.6x2
SPS-6555-03 65x55x2
SPS-8770-03 87x70x2

Blue line SPS series >

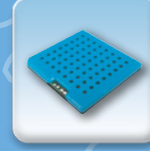

SPS-29-T00 29x32
SPS-41-T00 41x43.5
SPS-53-T00 53x61.2
SPS-68-T00 68x83.5

AMPLIFIERS

PAA SERIES >



PAA-LT3469-01 15x15

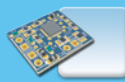

PAA-MAX9788-01 14x16.5

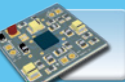

PAA-LM4960SQ-02 25x25

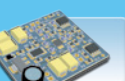

PAA-StepUpBTL-01 40x35

BUZZERS TRANSDUCERS

STANDARD Series

SVC STANDARD Series

SRA STANDARD Series

SMA Series

SMAT Series

SMB Series



® : registered trade name Patents: Several patents are worldwide protecting the original studies and development.
© : Copyright is reserved by Sonitron® n.v. for all pictures and texts.
Re-use or copies of a part may not be reproduced without written permission of Sonitron® n.v.

KEY QUESTIONS FOR BUZZER DETERMINATION

1. Mounting method: panel ? wall ? PCB ?

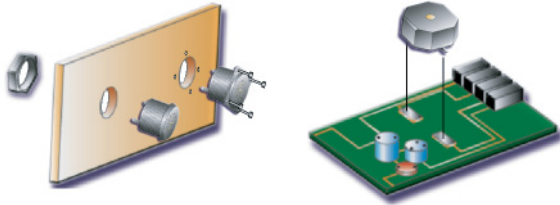

2. Connection method: wires ? pins (= through hole) ? fast-on ? SMD?



3. Maximum dimensions (in mm): diameter x height

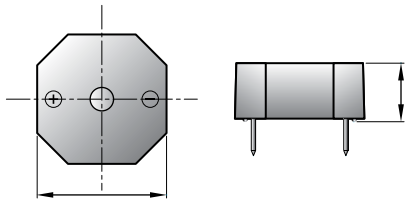

4. Pin distance (in mm)

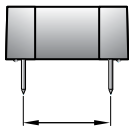

5. Supply voltage: DC for buzzers or AC for transducers



6. SPL – dB(A) @ 12Vdc, @ 30 cm or 1 meter

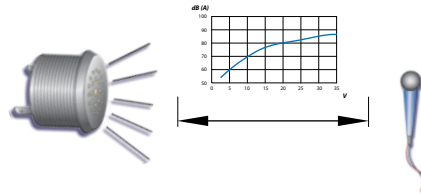

7. Sound frequency in Hz

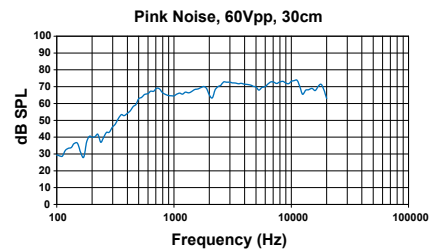

8. Current consumption in mA

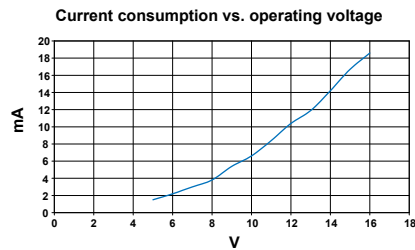

9. Temperature range in °C

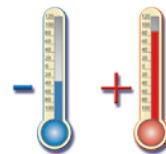

10. Life time

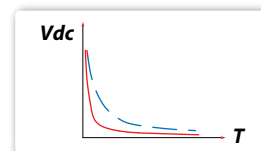

STANDARD SERIES



Since 1977, Sonitron continuously invested in research and development, optimising their standard series which are used today under the most extreme and difficult environmental circumstances, by clients such as the Nato, Airbus, Volvo Penta, Dräger, Knogo,...

During the last 30 years, the standard series have proved to be the prime alarm, giving your equipment an added value. Several thousands of clients all over the world have chosen for the reliability and the excellent quality of piezoceramic buzzers of Sonitron.

These series are strongly recommended in applications that are critical and life time in continuous function is tested. Critical applications are life support systems and equipment used to warn for life danger such as: portable gas detectors, medical monitoring equipment, aircraft cockpit alarm's, car breaking alarm's etc...

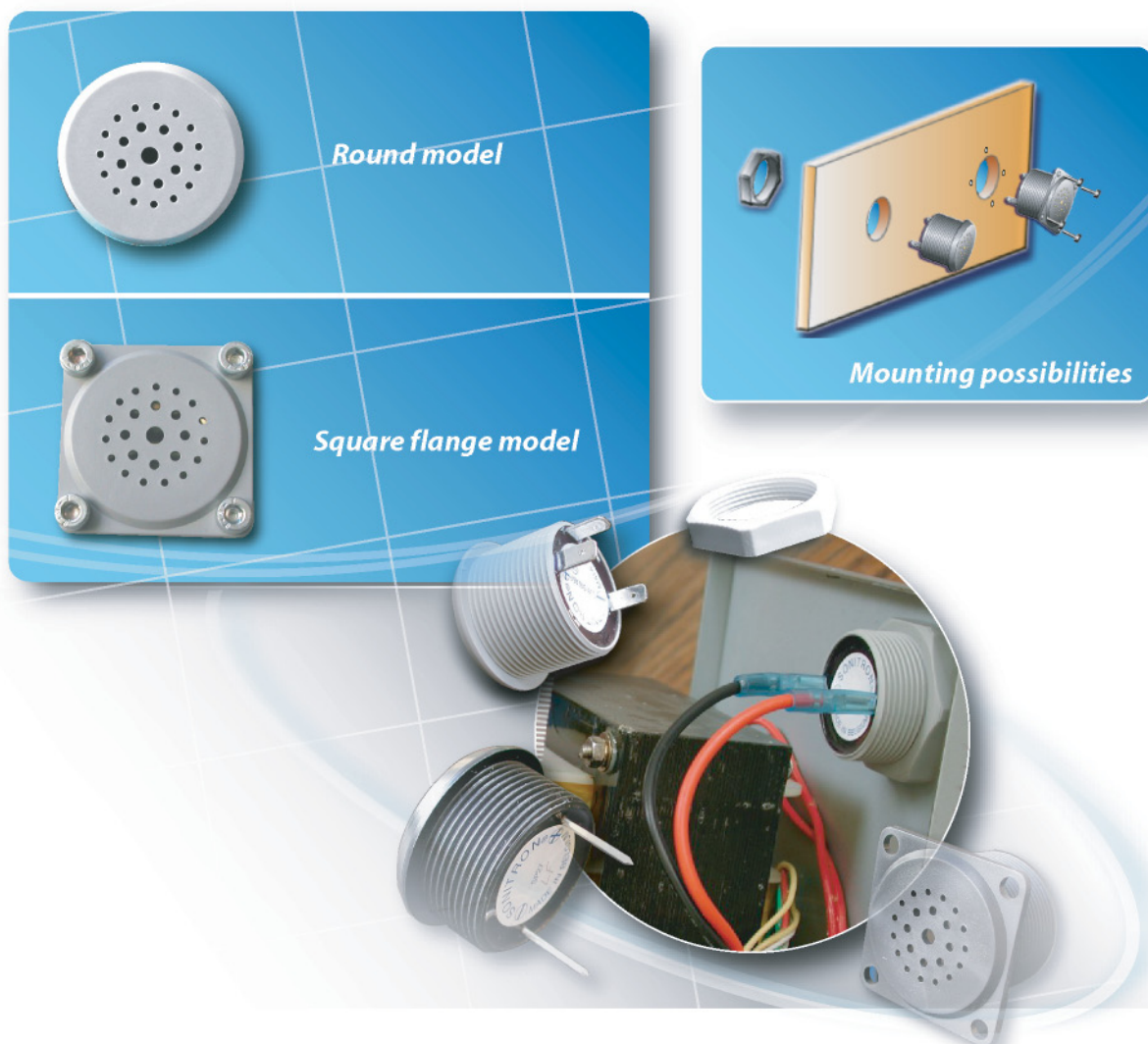

INTRODUCTION



The standard series are based on the highest piezo technology and are considered as most robust series for industrial applications. The standard buzzers use a special shaped membrane (curved edge), which is fixed and glued into the housing. They are shock proof, as well as dust and waterproof (IP67). The different standard models cover a wide range of applications, offering functions such as continuous, intermittent, sweep and warbler, with a sound output of more than 100 dB(A).

All standard buzzers are available with various mounting methods, such as PCB or panel mounting and therefore

are equipped with either pins or fast-on terminals. The standard series include military models, extra loud types, as well as models operating at very low voltage consumption (SC 0715 BL at 0.7V) and very low current (SP27 = 4,8 mA at 9V).

ADVANTAGES

- Extremely high sound pressure level with a very clear and penetrating sound output
- Solid state shock proof buzzer
- Dust and waterproof, rated to IP67
- PCB and panel mounting; pin or fast-on terminals
- Very high reliability
- Low power consumption
- Wide operating supply range
- Wide temperature range
- Electronics potted in epoxy
- Small in dimensions

APPLICATIONS

- Alarms
- Agricultural equipment
- Monitoring and test equipment
- Medical equipment
- Military equipment
- Trucks & automobiles
- Boats & airplanes
- Signalling & process control equipment
- Fire detectors
- Vending-machine
- Cockpit alarm
- Surveyance equipment
- Underground
- Traffic control
- Industrial washing machine

SPECIFICATIONS

*All measurements are made @ 1 meter @ 12 Vdc in free air @21°C.

Model	Function	Operating Voltage **		Frequency ± 15% (Hz)	Pulse rate (Hz)	Operating Current (mA)		SPL (dB(A))*
		min. Vdc	max. Vdc			@ V min.	@ V max.	
SC 235 A	contin.	2	35	2500	-	0.3	8.6	73
SC 235 B	contin.	2	35	3500	-	0.4	8.4	87
SCI 535 A1	multif.	5	35	2500	1	1.4	12.5	77
SCI 535 B1	multif.	5	35	3500	1	1.4	12.2	86
SCI 535 A5	multif.	5	35	2500	5	1.4	12.5	77
SCI 535 B5	multif.	5	35	3500	5	1.4	12.2	86
SCR 535 A	multif.	5	35	2500	20	1.4	12.6	82
SCR 535 B	multif.	5	35	3500	20	1.4	12.6	84
SW 535 B	warbler	5	35	3500	-	1.3	10.6	87
SUC 516 A	contin.	5	16	2500	-	1.8	13.3	92
SUC 516 B	contin.	5	16	3500	-	0.8	13.0	90
SULC 516 B	contin.	5	16	3500	-	2.0	13.3	97
SULI 516 B1	intermit.	5	16	3500	1	1.2	11.6	94
SULI 516 B5	intermit.	5	16	3500	5	1.2	11.6	94
SUM 516 A1	multif.	5	16	2500	1	1.8	11.6	93
SUM 516 A5	multif.	5	16	2500	5	1.8	11.6	93
SULM 516 B1	multif.	5	16	3500	1	2.4	14.2	96
SULM 516 B5	multif.	5	16	3500	5	2.4	14.2	96
SC 0715 BL	contin.	0.7	15	3500	-	0.3	13.4	98

Operating temperature	-40°C to +85°C
Storage temperature	-40°C to +85°C
Life time (at 21°C)	@12Vdc continuous use min. 2000 hours (expected life time curve in addendum)
Case material	ABS (UL rating: 94 HB)
Standard colour of case	Grey
Terminal material	Tinned brass for both pin terminals and fast-on terminals
Supplemental	Reverse voltage protected. Weight: 13g to 24g

SPECIALS

SP7	contin.	0.7	15	3500	-	0.3	13.4	71
SP27	contin.	4	16	3500	-	1.6	12	94
SCI 535 1700	multif.	5	35	1700	1	1.4	12.2	67

Operating temperature	-40°C to +85°C
Storage temperature	-40°C to +85°C
Life time (at 21°C)	@12Vdc continuous use min. 2000 hours (expected life time curve in addendum)
Case material	ABS (UL rating: 94 HB)
Standard colour of case	Grey (except the SP27 which is black)
Terminal material	Tinned brass for both pin terminals and fast-on terminals
Supplemental	Reverse voltage protected, except the SP27. Weight: 13g to 24g

Please note: objects in proximity of the buzzer cause reflections thereby the SPL can be increased or decreased.

MULTI-FUNCTIONALITY OF THE STANDARD SERIES

The standard series offer the client several functions in one single buzzer. The selection of a function is illustrated in the scheme below.

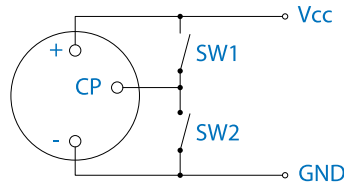

SW1	SW2	SCI 535	SUM 516	SULM 516	SCR 535
open	open	intermittent			cricket
closed	open	stop			stop
open	closed	continuous			continuous

SELECTION GUIDE

The selection of an acoustic signal can be complex. That is why we present below our standard models with their most appropriate application.

SC 235 A SCI 535 A1/A5	General purpose buzzer with medium sound output for soft alarm in industrial and military applications where a high reliability is requested. These buzzers can be used in a wide supply voltage range.
SC 235 B SCI 535 B1/B5	General purpose buzzer with high sound output for low power consumption. Ideally suitable for alarm and industrial sound signals. These models combine high performances and great reliability. Today, the SC 235 B is considered as the most popular type.
SW 535 B SCR 535 A/B	A warbler or cricket tone with a special sound effect for warning and alerting devices.
SC 0715 BL	Special loud buzzer that functions at very low voltage (0.7 Vdc), going up to 15 Vdc, producing 98 dB(A) @ 1 meter @ 12Vdc. Wide range of applications, including battery powered alarms.
SUM 516 A1/A5	A universal buzzer type with a selection mode of three functions: continuous, intermittent or stop. High sound output for low power consumption and low supply voltages. This type can be used for multiple applications where a soft signal is required and a high reliability is a must.
SULM 516 B1/B5 SULC 516 B SUC 516 A/B SULI 516 B1/B5	A universal buzzer with a selection mode of different functions: continuous, intermittent or stop. High sound output at very low power consumption. It can be used in all alarm and warning signals where performance, power consumption and size are important. The SULI and the SUC models are simplified versions of the SULM 516 B5 that can be used when mode control is not required.
SP 7	The SP7 Buzzer has a closed front to withstand high water pressure. It is extremely waterproof and used in extreme depth under water applications. Standard delivered with gasket (O-ring). 
SP 27	Small sized buzzer to be used in applications where space is limited.
SCI 535 1700	A buzzer for applications where a low frequency is required.

ELECTRICAL PARAMETERS

Current consumption vs. operating voltage

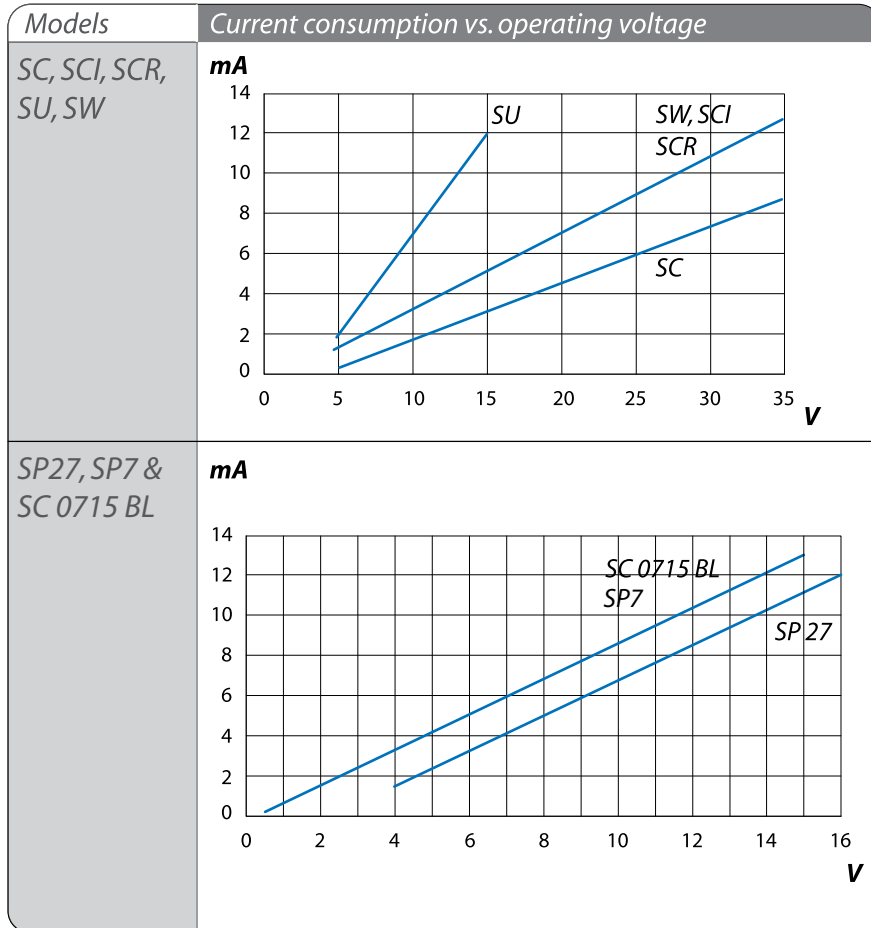

All measurements are made @ 12Vdc @ 1 meter in free air @ 21°C.

Sound pressure level vs. voltage

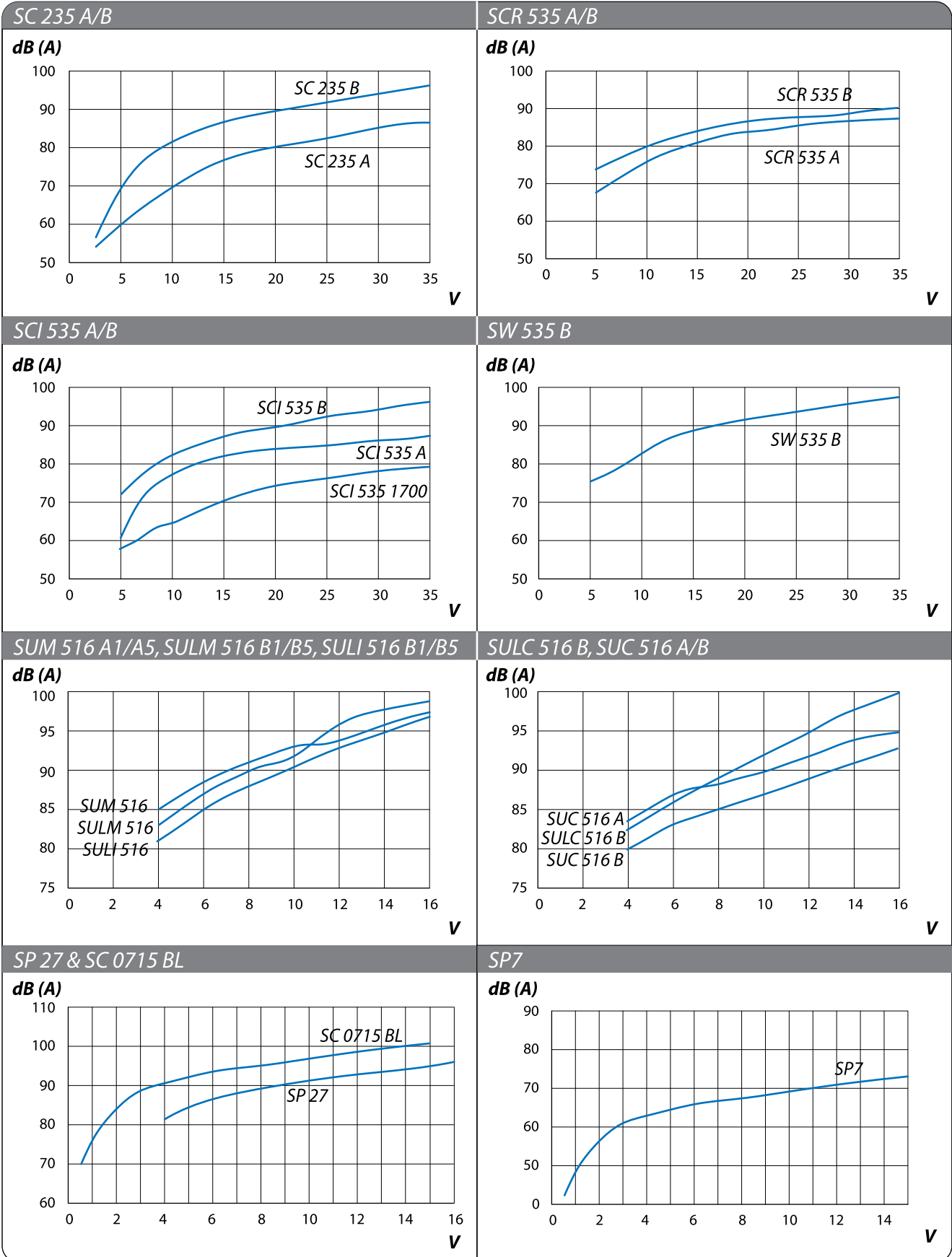

All measurements are made @ 12Vdc @ 1 meter in free air @ 21°C.

DIMENSIONS (All dimensions are in mm)

Round flange model	Square flange model	Mounting nut
<p>Note: all round and square flange models are available with all kinds of pin terminals.</p>		

Models (2 pins) SC, SW (3 pins) SCR, SCI

Pins	'fast-on' F	'fast-on' F2
<p>Note: control pin (CP) only with multifunction buzzers.</p>		

*0.8x2.3 Positioning lock

Models (2 pins) SUC, SULC, SULI (3 pins) SUM, SULM

Pins

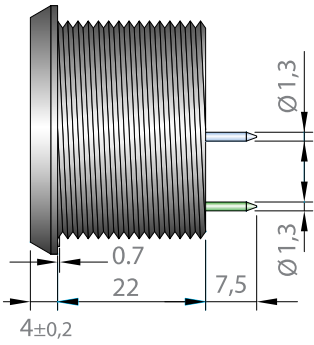

'fast-on' F

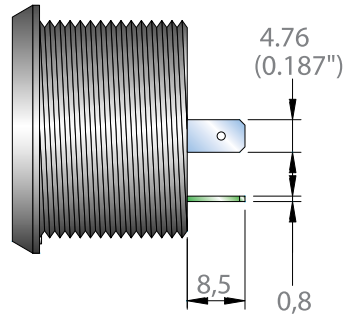

'fast-on' F2

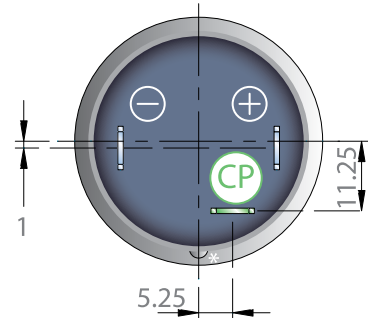
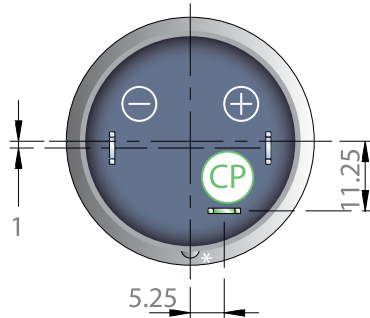
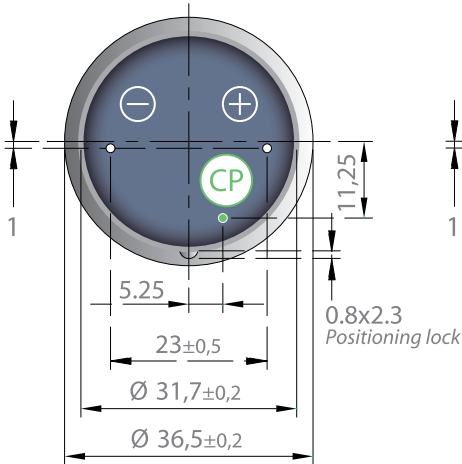
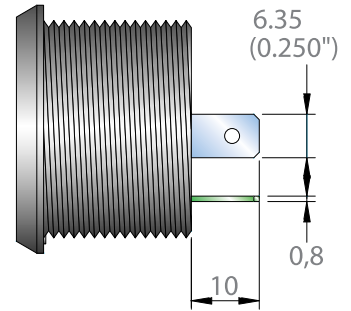

Model SP27

Pins

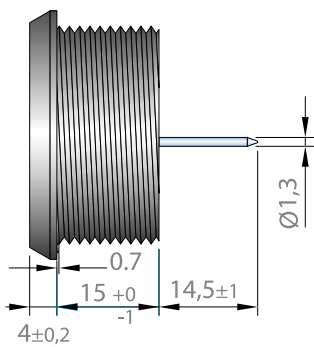

'fast-on' F

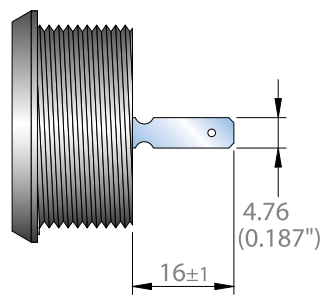

'fast-on' F2

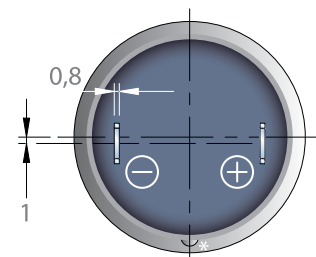
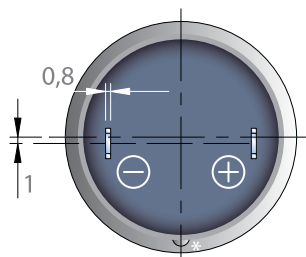
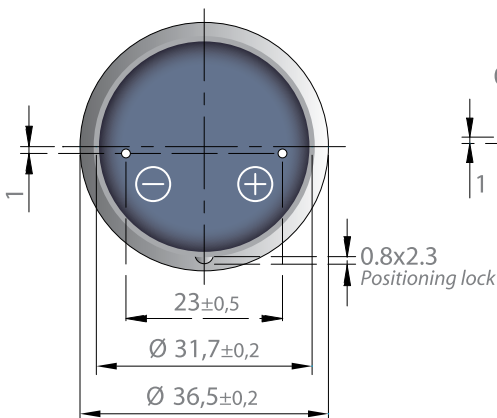
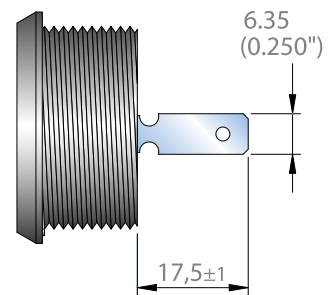

*0.8x2.3 Positioning lock

PRODUCT OPTIONS STANDARD SERIES

Option Code	example	Description
W100	SCO715BL-W100	With 2 wires: length 10cm (instead of 2 pins)
W100	SCI535B5-W100	With 3 wires: length 10cm (instead of 3 pins)
W150	SCO715BL-W150	With 2 wires: length 15cm (instead of 2 pins)
W300	SCO715BL-W300	With 2 wires: length 30cm (instead of 2 pins)
ACR	SC235A-ACR	Acryl coating: The protective coating gives a complementary protection against smog. All standard series buzzers are perfectly waterproof (IP67) without the mentioned coating.
Gasket (O-ring)	GASKET	Rubber sealing ring for waterproof assembly. SP7 is inclusive O-ring. For 100% watertight assembly the O-ring together with loctite 5331 can be used.

To order an option add the suffix to the model number of the standard series.

NUT All standard buzzers are delivered with a mounting nut.

MOUNTING GUIDELINES

Printed circuit-board:

- by soldering the terminals.

Front panel mounting:

- Panel mounting with a plastic nut. the buzzers can be mounted in panels up to 14 mm thickness (SP27 max. 7 mm). They are locked with a locking pin (dimensions 0.8x2.3mm) and secured to the panel with a plastic nut. Foresee a hole of diameter 32 mm (1.14"). Maximum torque on plastic nut: 6 Nm (wrench size 38mm). The step of the thread is 1.5 mm (M32x1.5).

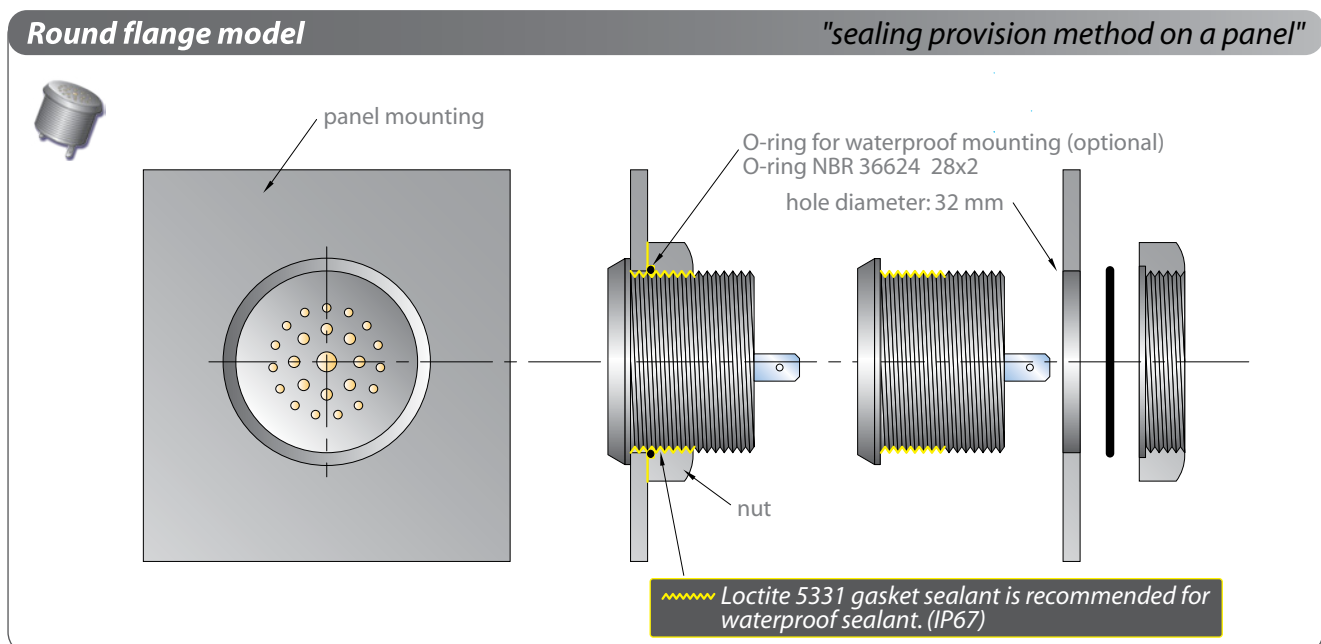

Square flange model

"sealing provision method on a panel"



Panel mounting square flange model with screws (M4).
 The square flange model can be mounted with 4x M4 screws instead of using the plastic nut. For waterproof mounting of the square flange model the nut must also be screwed on together with the optional O-ring.

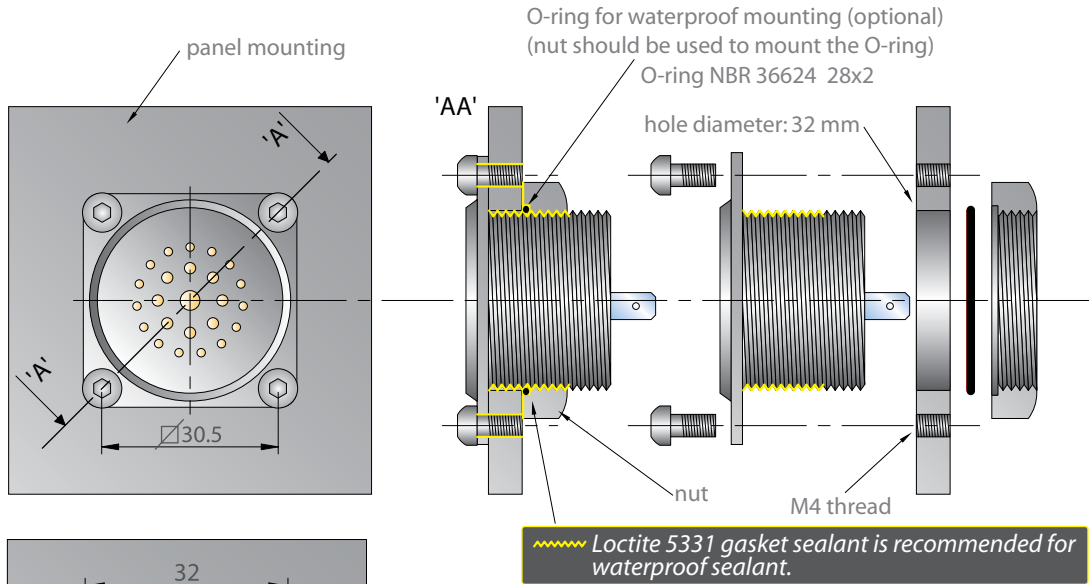

Hole dimensions (recommended)

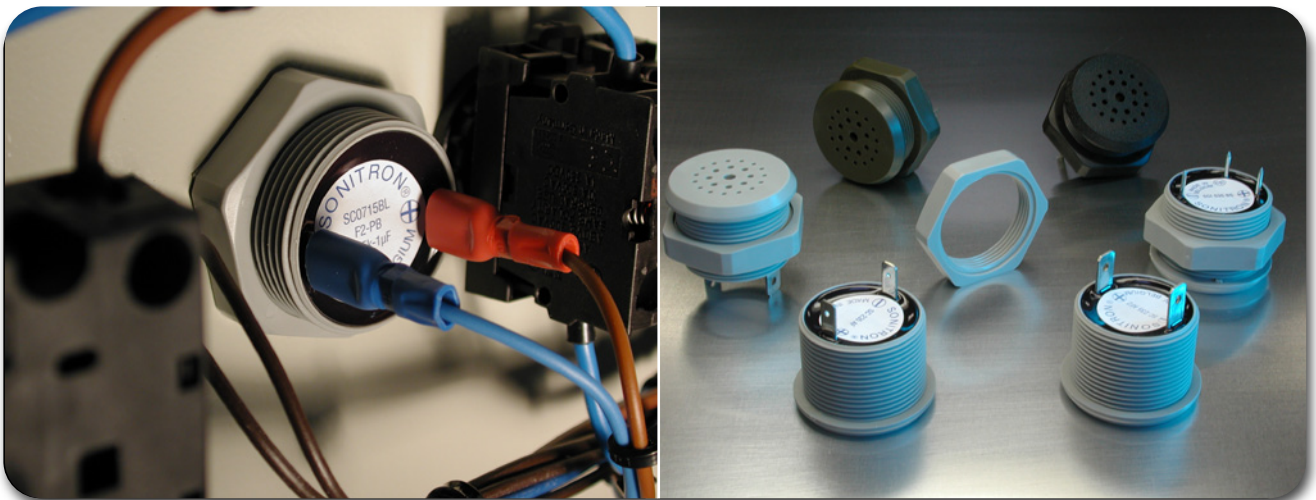

PRODUCT CODIFICATION

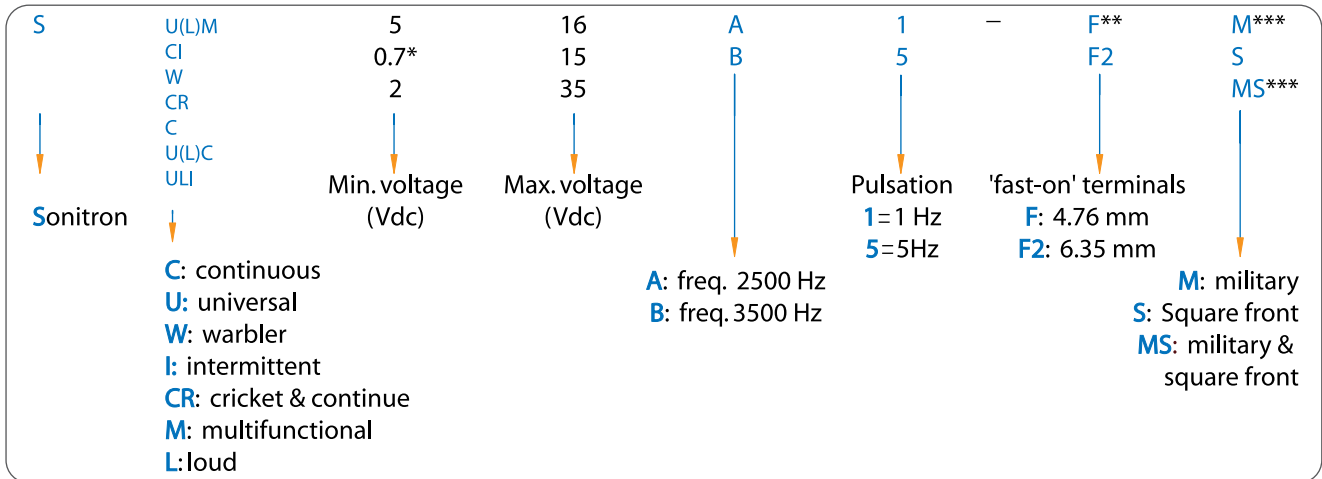

*0.7: 0.7 Vdc minimum voltage of the SC 0715 BL

F** If no terminal specification, the model is standard delivered with round pins, diameter 1.5 mm. Fast-on terminals are available in 2 dimensions: F= 4,76 mm (0,187 inch) or F2 = 6,35 mm (0,250 inch).

M*** Military norm MIL STD 202

LIST OF AVAILABLE PRODUCT TYPES

SC 235 A SC 235 A F SC 235 A F2 SC 235 A F M SC 235 A F2 M SC 235 A S SC 235 A F S SC 235 A F2 S SC 235 A F MS SC 235 A F2 MS	SC 235 B SC 235 B F SC 235 B F2 SC 235 B F M SC 235 B F2 M SC 235 B S SC 235 B F S SC 235 B F2 S SC 235 B F MS SC 235 B F2 MS	SC 0715 BL SC 0715 BL F SC 0715 BL F2 SC 0715 BL F M SC 0715 BL F2 M SC 0715 BL S SC 0715 BL F S SC 0715 BL F2 S SC 0715 BL F MS SC 0715 BL F2 MS	SP27 SP27 F SP27 F2 SP27 F M SP27 F2 M SP27 S SP27 F S SP27 F2 S SP27 F MS SP27 F2 MS	SCI 535 A1 SCI 535 A1 F SCI 535 A1 F2 SCI 535 A1 F M SCI 535 A1 F2 M SCI 535 A1 S SCI 535 A1 F S SCI 535 A1 F2 S SCI 535 A1 F MS SCI 535 A1 F2 MS SCI 535 1700	SCI 535 A5 SCI 535 A5 F SCI 535 A5 F2 SCI 535 A5 F M SCI 535 A5 F2 M SCI 535 A5 S SCI 535 A5 F S SCI 535 A5 F2 S SCI 535 A5 F MS SCI 535 A5 F2 MS
SCI 535 B1 SCI 535 B1 F SCI 535 B1 F2 SCI 535 B1 F M SCI 535 B1 F2 M SCI 535 B1 S SCI 535 B1 F S SCI 535 B1 F2 S SCI 535 B1 F MS SCI 535 B1 F2 MS	SCI 535 B5 SCI 535 B5 F SCI 535 B5 F2 SCI 535 B5 F M SCI 535 B5 F2 M SCI 535 B5 S SCI 535 B5 F S SCI 535 B5 F2 S SCI 535 B5 F MS SCI 535 B5 F2 MS	SCR 535 A SCR 535 A F SCR 535 A F2 SCR 535 A F M SCR 535 A F2 M SCR 535 B S SCR 535 A F S SCR 535 A F2 S SCR 535 A F MS SCR 535 A F2 MS	SCR 535 B SCR 535 B F SCR 535 B F2 SCR 535 B F M SCR 535 B F2 M SCR 535 B S SCR 535 B F S SCR 535 B F2 S SCR 535 B F MS SCR 535 B F2 MS	SUC 516 A SUC 516 A F SUC 516 A F2 SUC 516 A F M SUC 516 A F2 M SUC 516 A S SUC 516 A F S SUC 516 A F2 S SUC 516 A F MS SUC 516 A F2 MS	SUC 516 B SUC 516 B F SUC 516 B F2 SUC 516 B F M SUC 516 B F2 M SUC 516 B S SUC 516 B F S SUC 516 B F2 S SUC 516 B F MS SUC 516 B F2 MS
SULC 516 B SULC 516 B F SULC 516 B F2 SULC 516 B F M SULC 516 B F2 M SULC 516 B S SULC 516 B F S SULC 516 B F2 S SULC 516 B F MS SULC 516 B F2 MS	SUM 516 A1 SUM 516 A1 F SUM 516 A1 F2 SUM 516 A1 F M SUM 516 A1 F2 M SUM 516 A1 S SUM 516 A1 F S SUM 516 A1 F2 S SUM 516 A1 F MS SUM 516 A1 F2 MS	SUM 516 A5 SUM 516 A5 F SUM 516 A5 F2 SUM 516 A5 F M SUM 516 A5 F2 M SUM 516 A5 S SUM 516 A5 F S SUM 516 A5 F2 S SUM 516 A5 F MS SUM 516 A5 F2 MS	SULI 516 B1 SULI 516 B1 F SULI 516 B1 F2 SULI 516 B1 F M SULI 516 B1 F2 M SULI 516 B1 S SULI 516 B1 F S SULI 516 B1 F2 S SULI 516 B1 F MS SULI 516 B1 F2 MS	SULI 516 B5 SULI 516 B5 F SULI 516 B5 F2 SULI 516 B5 F M SULI 516 B5 F2 M SULI 516 B5 S SULI 516 B5 F S SULI 516 B5 F2 S SULI 516 B5 F MS SULI 516 B5 F2 MS	SULM 516 B1 SULM 516 B1 F SULM 516 B1 F2 SULM 516 B1 F M SULM 516 B1 F2 M SULM 516 B1 S SULM 516 B1 F S SULM 516 B1 F2 S SULM 516 B1 F MS SULM 516 B1 F2 MS
SULM 516 B5 SULM 516 B5 F SULM 516 B5 F2 SULM 516 B5 F M SULM 516 B5 F2 M SULM 516 B5 S SULM 516 B5 F S SULM 516 B5 F2 S SULM 516 B5 F MS SULM 516 B5 F2 MS	SW 535 B SW 535 B F SW 535 B F2 SW 535 B F M SW 535 B F2 M SW 535 B S SW 535 B F S SW 535 B F2 S SW 535 B F MS SW 535 B F2 MS	SP 7 SP 7 F SP 7 F2 SP 7 M SP 7 M SP 7 S SP 7 F S SP 7 F2 S SP 7 F MS SP 7 F2 MS			

MILITARY MODELS



Our patented bended edge membranes permit us to realize military applications. We deliver since more than 30 years piezo acoustic components on military specifications.

Our products are used in portable radio's, de-icing detection, airplane cockpit alarms...

We are since more than 20 years Navo approved for several models.

We warned in time at critical moments...

Military test conditions MIL STD202

The military models guarantee a quality superior to the classic models. On top of the standard specifications, the military models are tested as follows:

Test	Method MIL STD202	Test conditions
Thermal Shock	107	A
Humidity	103	B
Salt Spray	101	A
Shock	213 B	H
Vibration	201 A	none
Terminal strength	211	A (10 Lbs, 2 cycles)

The different tests are summarised below. The detailed procedures are available upon special request.

Thermal shock test 107 method A: The thermal shock test is performed to determine the resistance of a part to exposures at extremes of high and low temperatures, and to the shocks of alternate exposures to these extremes, such as would be experienced when equipment or parts are transferred to and from heated shelters in arctic areas. The products are exposed to a flow of air at different temperatures for at least 5 cycles.

Humidity test 103 method B: This test is performed to evaluate the properties of materials used in components as they are influenced by the absorption and diffusion of moisture and moisture vapour.

This accelerated environmental test is accomplished by the continuous exposure of the specimen to high relative humidity at an elevated temperature during 96 hours.

Salt spray test 101 method A: The purpose of this test is to define if the product is resistant to salt spray. This accelerated laboratory corrosion test simulates the effects of seacoast atmospheres on metals. The coating of the product is subjected to a fine mist of salt solution during 96 hours.

Shock test 213B method H: The shock test (Sawtooth pulse during 6Ms) is conducted for the purpose of determining the suitability of component parts and subassemblies of electrical and electronic components when subjected to shocks such as those which may be expected as a result of rough handling, transportation and military operations. The design of the shock machine is not specified, but shock pulse waveforms are specified with tolerances.

Vibration test 201 A: The vibration test is used to determine the effects on component parts of vibration within the predominant frequency ranges and magnitudes that may be encountered during the field service. The specimen is mounted on a special apparatus and subjected to a simple harmonic motion.

Thermal strength test 211 method A: This test is performed to determine if the design of the product and its method of attachment can withstand one or more of the applicable mechanical stresses to which they will be subjected during installation or disassembly in equipment. This pull of tension test is gradually applied and then maintained for a period of 5 to 10 seconds.

NATO approved models

All standard models can be delivered in a military version. All military models have flame retardant ABS housings in olive green, fast-on terminals and the membrane is foreseen with a special protective coating.

Ref. Nr.:	NSN (NATO stock number)	Type
SC 235 A	6350-13-113-8057	4
SC 235 B	6350-13-112-5782	
SC 235 AF2 BLACK	6350-13-116-5836	1
SC 235 AF2	6350-13-120-1787	4
SC 235 BF2	6350-13-120-1788	
SC 235 AFM	6350-13-116-8221	4
SC 235 A-M	6350-13-118-3500	1
SC 235 BF	6350-13-113-4698	4
SC 235 B FM	6350-13-113-4504	
SUM 516 A	6350-13-113-6319	4
SULM 516 B1 FM	6350-13-113-6108	4
SULM 516 B5	6350-13-120-6689	1
SULM 516 B5-F	6350-13-118-9573	
SCI 535 A1-F2	6350-13-119-8080	4
SCI 535A1-M Green	6350-13-118-1179	4
SCI 535 A1 FM	6350-13-114-1876	4
SCI 535 B1 FM	6350-13-113-6092	4
SCI 535 B1	6350-13-114-8156	1
SCI535 B1-Black	6350-13-1205625	1
SCI 535 B1-F2	6350-13-116-9171	1
SCI 535 B5	6350-13-113-1553	
SCI 535 B5-F-48X05N	6350-13-118-3502	4
SCI 535 B5-F	6350-13-1206614	1
SCI 535 B5-FM	6350-13-113-1553	4
SCR 535 A	6350-13-113-2787	4
SCI 535 A1-F2	6350-13-119-8080	
SCR 535 B	6350-13-115-0297	4
SCR 535 B FM	6350-13-114-1875	1
SC 0715 BLF	6350-13-115-6688	1
SC 0715 BL-F2-M	6350-13-116-8321	4
SC 0715 BL	6350-13-118-6691	4
SMA-21B-P17,5	6350-13-114-5188	4
SMA-21B-P10	6350-13-115-6615	1
SMAT-21	5965-13-117-8832	4
SMA-21-P17.5	6350-13-1207739	1
SMA-21L-P17.5	6350-13-118-8899	4
SMA-24A-P10	6350-14-501-0602	
SMA-30-P20.32	6350-13-119-4461	4
SW 535 B	6350-13-119-7615	1
SW 535B-M	6350-13-118-2999	4
SP27-F-M	6350-13-118-4720	2

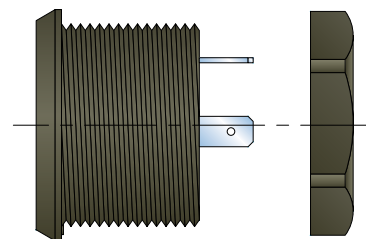
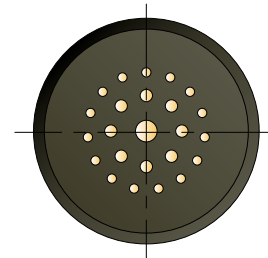

MODELS ON REQUEST

The standard buzzers can be modified upon request in order to deliver a product meeting the requirements of the customer's application.

- Upon special request all standard models are also available in GREY, BLACK or GREEN (khaki). Please add GREY, BLACK or GREEN to the part number if the required colour is different from the one specified as standard.
- For applications under aggressive humid conditions, Sonitron also deliver a special model in which the piezo element is covered with a protective coating. Add ACR to the part number. The protective coating gives a complementary assurance against smog; all standard models are perfectly waterproof (IP67) without the mentioned coating.
- Different pin terminal lengths, straight or bent, can be custom made.
- The frequency, indicated in the present catalogue, has an accuracy of $\pm 15\%$. Standard buzzers with an improved frequency accuracy (up to $\pm 2\%$) are available upon special customer request.

For more information, please email sales@keiconn.com.

PACKAGING

All standard buzzers are packed in polystyrene boxes of 26.5 x 26.5 cm ; 25 pieces per box.

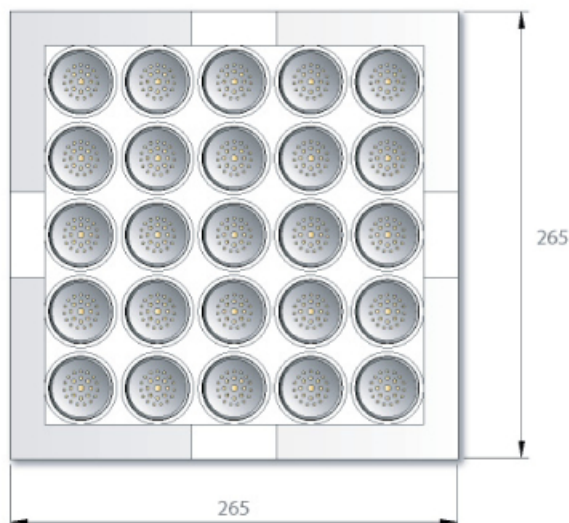

SVC Series Vehicle Control STANDARD SERIES

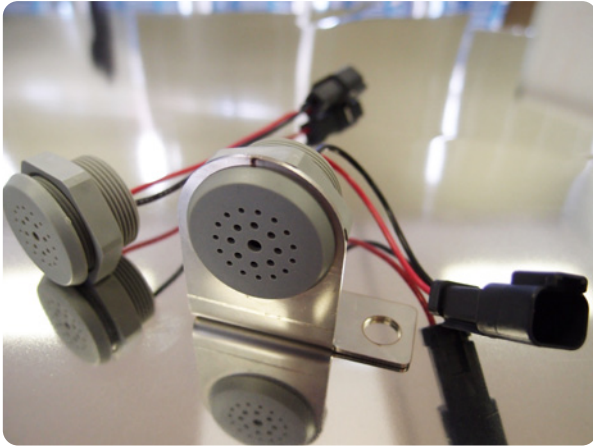

The **Sonitron Vehicle Control** standard series are a total solution for vehicle move control. The construction is based on the standard series with a long life time and ruggedized housing.

A stainless steel mounting bracket, solid connection wires and industrial - automotive rugged connector secures all the mechanical strength you need. This total package is designed for direct use on 12V or 24V car battery with an internal trigger function to avoid unwanted activation.

ADVANTAGES & APPLICATIONS

ADVANTAGES :

- Up to 40Vdc
- Designed for battery applications 12V/24V
- Life time > 2000 hours (@1m@12Vdc in free air @21°C)
- Low power consumption
- Wrong polarity protected
- SS-304 mounting bracket
- Deutch Connector & 16 AWG wires
- Trigger-on function (7.5V or 15.75V)
- IP67 Dust and Waterproof

- Temperature range -40°C to +85°C
- Shock protection during displacement

APPLICATIONS :

- Total Vehicle Control for several applications
- Agricultural machinery
- Hoisting crane machinery
- Mining equipment

SPECIFICATIONS



**All measurements are made @ 1 meter @ 12Vdc in free air @ 21°C*

Model	Function	DC Battery	Activation Trigger-on	Frequency +/- 15% (Hz)	Pulse Rate (Hz)	SPL dB(A) @1m*
SVC 7C	Contin.	12V	7.5V	2500	-	90
SVC 7I	Intermit.	12V	7.5V	2500	1	90
SVC 15C	Contin.	24V	15.75V	2500	-	90
SVC 15I	Intermit.	24V	15.75V	2500	1	90

Operating temperature	-40°C to +85°C
Storage temperature	-40°C to +85°C
Life Time (@21°C)	@12Vdc continuous use min. 2000 hours (expected life time curve see catalogue p 138)
Case Material	ABS (UL rating: 94HB)
Standard colour of case	Grey
Weight	64g
Max Voltage	40Vdc
current consumption (range 7.5Vdc to 40Vdc)	15mA

ELECTRICAL PARAMETERS

The buzzer is designed to produce a sound output of 90 dB(A) at 1 meter and can be used in applications up to 40Vdc.

The buzzer only starts when the trigger DC voltage has been reached.

- The SVC 7I and SVC 7C are starting sounding from 7.5 V dc.
- The SVC 15I and SVC 15C are starting sounding from 15.75V dc.

DIMENSIONS (All dimensions are in mm)

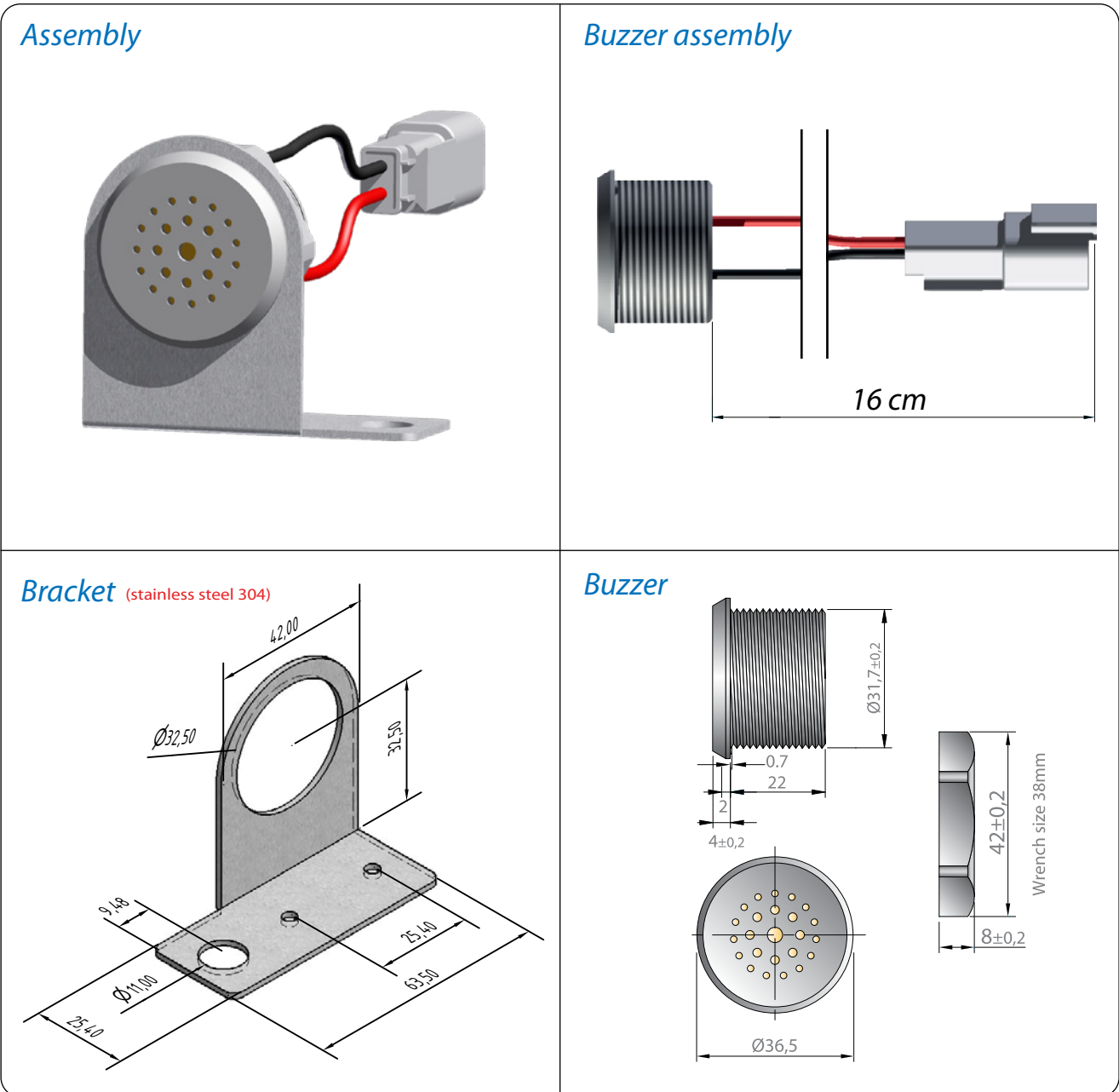

LIST OF AVAILABLE PRODUCT TYPES

SVC 7C	SVC 15C
SVC 7I	SVC 15I

SRA Series Robust Applications STANDARD SERIES

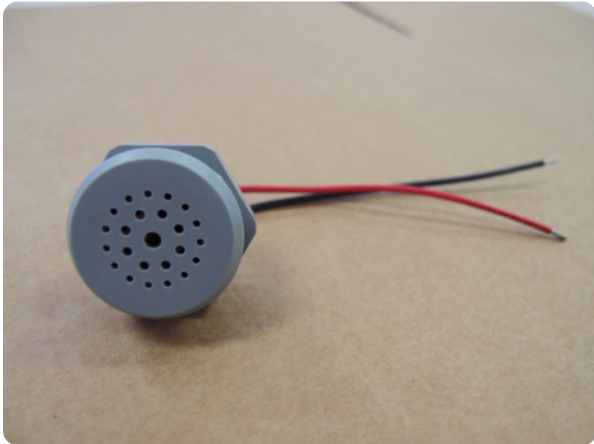

The **Sonitron Robust Application** standard series are an important extension of the Standard series.

A superior Life Time has been obtained with a very large DC voltage range from 5Vdc up to 80Vdc. Equipped with 16 AWG wires this buzzer can be used in any harsh industrial environment.

Sonitron expanded with this series a wide application field and strong reliability, especially recommended in critical applications and life support systems.

ADVANTAGES & APPLICATIONS

ADVANTAGES :

- Up to 80Vdc
- Solid state shock proof buzzer
- Life time > 2000 hours
- Very low power consumption (typical 15mA@12Vdc)
- Wrong polarity protected
- Panel mounting, O-ring included
- 16 AWG wire connections (14cm)
- High reliability

- IP67, Dust and waterproof
- Temperature range -40°C to +85°C

APPLICATIONS :

- Industrial
- Automotive Vehicles
- Process & Alarm equipment
- Security & Burglar alarms

SPECIFICATIONS



**All measurements are made @ 1 meter @ 12Vdc in free air @ 21°C*

Model	Function	MIN Vdc	MAX Vdc	Frequency +/- 15% (Hz)	Pulse Rate (Hz)	SPL dB(A) +/-4dB @1m@12Vdc*
SRA 80C A	Contin.	5V	80V	2500	-	93
SRA 80I A1	Intermit.	5V	80V	2500	1	92
SRA 80I A5	Intermit.	5V	80V	2500	5	92
SRA 80C B	Contin.	5V	80V	3500	-	95
SRA 80I B1	Intermit.	5V	80V	3500	1	94
SRA 80I B5	Intermit.	5V	80V	3500	5	94

Operating temperature	-40°C to +85°C
Storage temperature	-40°C to +85°C
Life Time (@21°C)	@12Vdc continuous use min. 2000 hours (expected life time curve see catalogue p138)
Case Material	ABS (UL rating: 94HB)
Standard colour of case	Grey
Weight	34g
Max current consumption	15mA
Wire	16 AWG, 14cm

ELECTRICAL PARAMETERS

The buzzer starts sounding from 5Vdc. The sound output increases with raising voltage up to 15Vdc. From 15Vdc to maximum voltage of 80Vdc the sound output remains the same.

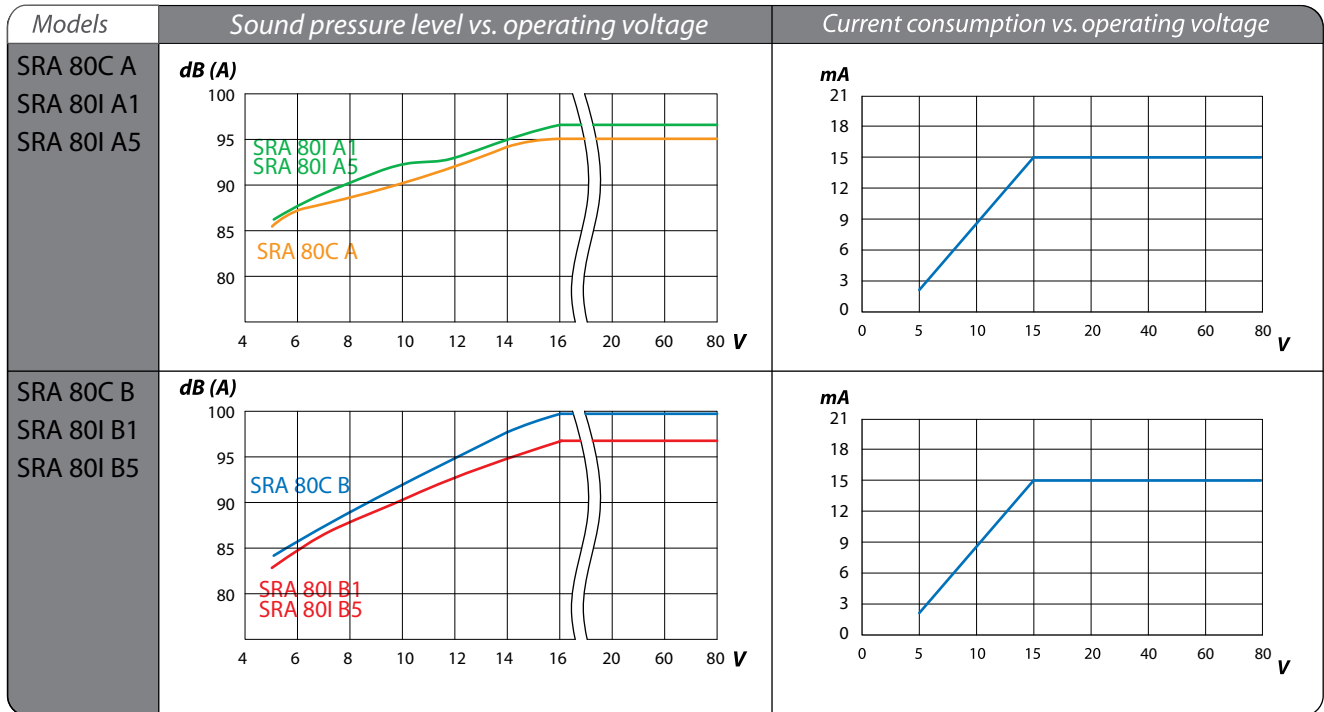

All measurements are made @ 12Vdc @ 1 meter in free air @ 21°C.

DIMENSIONS (All dimensions are in mm)

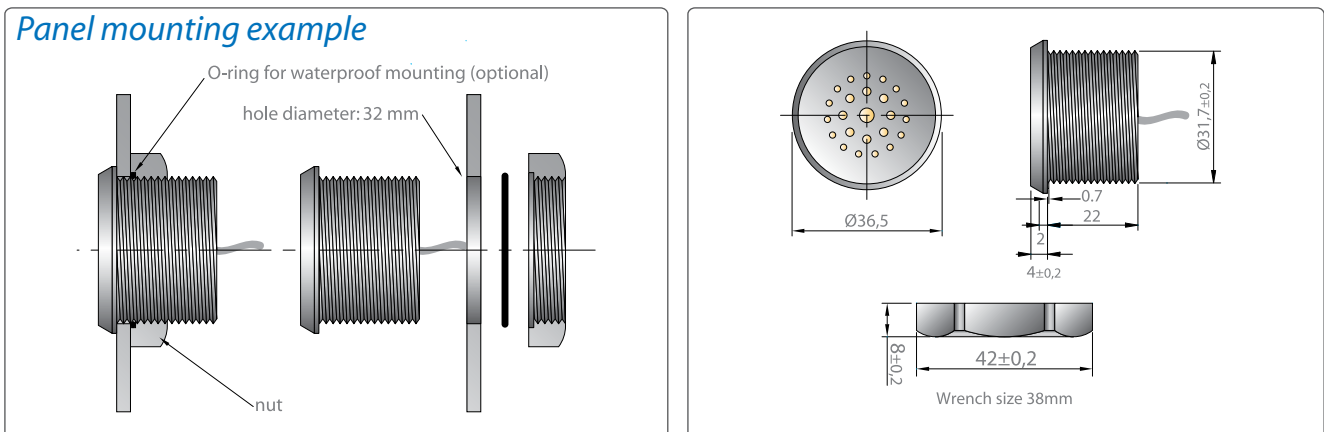
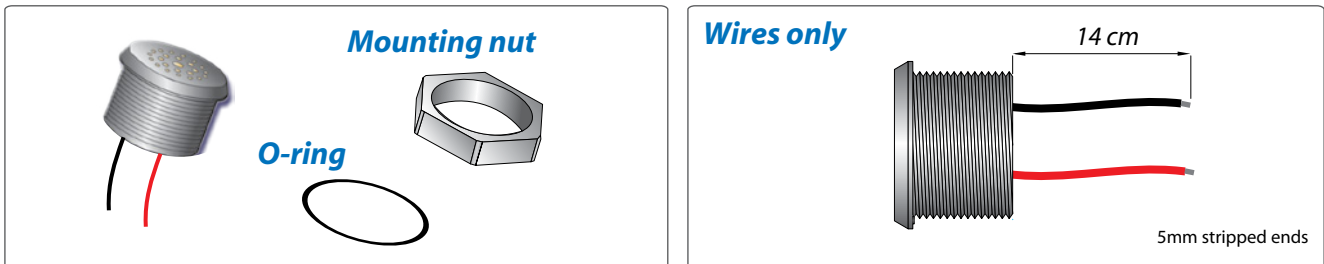

LIST OF AVAILABLE PRODUCT TYPES

SRA 80C A	SRA 80I A1	SRA 80I A5
SRA 80C B	SRA 80I B1	SRA 80I B5

Foam Patch Option - FP

sonitron® products



The **Sonitron Foam Patch Option** offers extra mechanical and acoustical stability to the Sonitron Sound components in applications for rugged or difficult environment. The patches are made out of double coated urethane foam tape. The sound components are with the foam patch option very easy to stick and secure precise and stable mounting, especially when SMD sound components are used in applications that have to withstand high vibrations.

The shape of the foam patch is optimized according to the Sonitron sound component. The material, temperature, strength, adhesive and thickness are well chosen to give a maximum benefit. It cancels unwanted disturbances between the PCB panel and the house of the sound component which results in more acoustic sound stability.

ADVANTAGES & APPLICATIONS

ADVANTAGES :

- Mechanical Stabilization
- Acoustic Stabilization
- Less distortion
- Easy mounting
- High temperature resistance
 - Short Term (minutes, hours: 193°C)
 - Long Term (Days, Weeks 104°C)
- Protects the sound component against vibrations

APPLICATIONS :

- Sonitron sound components
- SMA(T) series, SMB series, SCS series, SMAC series

AVAILABLE FOAM PATCHES

10 different foam patches cover the four Sonitron piezoelectric sound component series for PCB mounting.

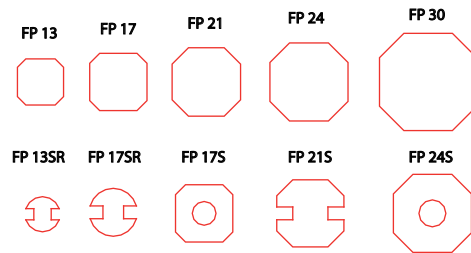

To order the option, add the **FP** suffix to the model number!

- e.g. SMA-17LC-P10 FP
- e.g. SMA-21LT-P15 FP
- e.g. SMAT-30-P17.5 FP
- e.g. SCS-32-S SP02 FP

Option	Nr.	Sonitron Products - SMA(T) - SMB - SMAC - SCS Series		
FP	13	SMA(T)-13 P7.5 SMA(T)-13 P10	SMA(T)-21S	SMB-17CC P10
FP	17	SMA(T)-17 P7.5 SMA(T)-17 P10	SMA(T)-24S	
FP	21	SMA(T)-21 P10 SMA(T)-21 P15 SMA(T)-21 P17.5	SMA(T)-30S	SMAC(I) - 25 P15 SMAC(I) - 25 P17.5
FP	24	SMA(T)-24 P10 SMA(T)-24 P15 SMA(T)-24 P17.5 SMA(T)-24 P20.32		SMB-32CC P10 SMB-32CC S
FP	30	SMA(T)-30 P10 SMA(T)-30 P15 SMA(T)-30 P17.5 SMA(T)-30 P20.32		
FP	13SR	SMA(T)-13 S		
FP	17SR	SMA(T)-17 S		
FP	17S	SCS-24-P10 SCS-24-S		
FP	21S	SMAC(I) - 25S		
FP	24S	SCS-32-P10 SCS-32-S		

MULTI-APPLICATION SERIES

SMA & SMAT

INTRODUCTION

The Sonitron Multi-Application (SMA) series are specifically developed to meet a wide range of requirements in sound pressure, dimensions and mounting methods. This series produce highly reliable audible signals, giving either an extremely clear penetrating tone or a soft sound output. Both, buzzers and transducers, are available in five sizes, 13 mm, 17 mm, 21 mm, 24 mm and 30 mm. All SMA products are manufactured to meet various mounting styles such as through-hole or surface mounting technologies (SMD). Therefore they are equipped with either pin or SMD terminals.

The Multi-Application series present the following advantages:

- The octagonal housing provides alignment with pick & place machines for SMD models, which are packed in trays and protected with a heat resistant label for automatic soldering.
- The miniature models SMA-13 and SMA-17 offer a high sound pressure level together with a clear audible tone.
- The LT-versions of the models SMA-13, SMA-17 and SMA-21 generate an increased sound output. The LC-versions of the same models operate at extremely low current consumption; ideal for battery operated applications.
- The LV versions of the model SMA-21 generate an extremely loud sound output at very low battery voltage starting at 2 Vdc up to 6 Vdc.
- Because of the same case style for buzzers and transducers with different pin pitches per model, the user is offered a great deal of flexibility and can switch over to a buzzer or transducer at any time.
- The piezo audio technology can be qualified as solid state, highly reliable, without EMI and is able to withstand temperatures from -40°C to $+85^{\circ}\text{C}$. The MTBF exceeds in reality several times the figure indicated in this catalogue. Lifetime depends on different factors and is described more in detail in the addendum.



SELECTION GUIDE

The selection of an acoustic signal can be complex. The list below indicates the use of a certain buzzer model at a certain distance and frequency. It is important to take into account that every application is different and that the perception of a sound is very subjective.

frequency	Average distance from the source in free air				
	0 to 1m	1 to 2m	2 to 3m	3 to 4m	4 to 5m
2 kHz to 3 kHz	SMAT-13 SMAT-17 SMA-13 SMA-17	SMAT-13 SMAT-17 SMAT-21 SMA-13LC SMA-17LC SMA-17L SMA-21LV	SMAT-13 SMAT-17 SMAT-21 SMA-13LC SMA-17LC SMA-17L SMA-21LV	SMAT-30 SMA-21LV SMA-30 SMA-30L	SMAT-30 SMA-21LV SMA-30 SMA-30L
2.5 kHz to 3 kHz	SMAT-17 SMA-17LC SMA-17L SMA-21 SMA-21LC SMA-21L SMA-21LV	SMAT-17 SMA-17LC SMA-17L SMA-21 SMA-21LC SMA-21L SMA-21LV	SMA-24 SMA-24L SMA-17LC SMA-17L SMA-21LV	SMA-24 SMA-24L SMA-17LC SMA-17L SMA-21LV	SMA-24 SMA-24L SMA-17LC SMA-17L SMA-21LV
3 kHz to 3.8 kHz	SMAT-17 SMAT-21 SMA-17 SMA-17LT SMA-21 SMA-21LT	SMAT-17 SMAT-21 SMA-17 SMA-17LT SMA-21 SMA-21LT	SMAT-17 SMAT-21 SMAT-24 SMAT-30 SMAC-25 SMA-17LT SMA-17LC SMA-17L SMA-21LT SMA-21LC SMA-21L SMA-30 SMA-30L	SMAT-17 SMAT-21 SMAT-24 SMAT-30 SMAC-25 SMA-17LT SMA-17LC SMA-17L SMA-21LT SMA-21LC SMA-21L SMA-30 SMA-30L	SMAT-17 SMAT-21 SMAT-24 SMAT-30 SMAC-25 SMA-17LT SMA-17LC SMA-17L SMA-21LT SMA-21LC SMA-21L SMA-30 SMA-30L

SMA SERIES



The Sonitron Multi-Application buzzers are low cost commercial grade components for large volume applications. The SMA series are designed to meet various requirements such as current consumption, voltage, sound pressure, mounting methods, connection, dimensions and packaging. They are available in five sizes: 13 mm, 17 mm, 21 mm, 24 mm and 30 mm. The buzzers have a built-in oscillator generating their working frequency. They produce a highly reliable audible tone signal, giving either an extremely clear and penetrating tone or a soft sound for non-aggressive signals.

ADVANTAGES & APPLICATIONS

ADVANTAGES :

- Octagonal form
- Models with different pin pitches
- Light but solid state construction
- Little power consumption, especially the extra loud LC-versions
- Wide voltage range (1,5V to 24V)
- Easy mountable
- SMA-13 and SMA-17 for applications with limited space
- SMD models with heat resistant label for protection during automatic soldering
- Automatic pick & place

APPLICATIONS :

- Automatic doors
- Alarms
- Gas & metal detectors
- Weighing & measuring equipment
- Medical instrumentation
- Timers & clocks
- Control instrumentation & systems
- Copiers
- Automobiles & trucks
- Games & toys
- Computer peripherals
- Cash registers

SPECIFICATIONS

Model	SPL * (dB(A))	Frequency (+/-15%) Hz)	Operating Voltage (min.-max.)	Operating current (mA)	Weight (g)
SMA-13	75	3000	1.5 to 24	1.8	1
SMA-13LT	82	3000	1.5 to 15	11.6	1
SMA-13LC	81	3000	1.5 to 15	0.7	1
SMA-13LV	80 @ 3V	3350	2 to 4	13 @ 3V	1
SMA-17	82	3000	1.5 to 24	3.3	2
SMA-17L	88	3000	1.5 to 24	5	2
SMA-17LT	86	3000	1.5 to 15	15	2
SMA-17LC	89	3500	1.5 to 15	0.8	2
SMA-21	85	3300	1.5 to 24	3.8	2.5
SMA-21L	91	3300	1.5 to 24	5	2.5
SMA-21LT	90	3300	1.5 to 15	12.5	2.5
SMA-21LC	91	3800	1.5 to 15	1.1	2.5
SMA-21LV	87 @ 3V	3000	2 to 6	13 @ 3V	2.5
SMA-24	92	3000	1.5 to 24	4.2	4
SMA-24L	98	3000	1.5 to 15	6.7	4
SMAI-24	92	**3500	5 to 24	6.2	4
SMA-30	87	2500	1.5 to 24	4.1	5
SMA-30L	97 @ 9V	2500	3 to 9	5 @ 9V	5

* All measurements are made in free air @ 21°C @ 30cm @ 12Vdc (Except for the SMA-21LV & SMA-30 L). Buzzers soldered on a PCB board with dimensions of 24cmx11cm.

** SMAI 24: intermittent pulse rate of 5Hz (@ 15Vdc). All the other models have a continuous tone.

Operating temperature	-20°C to +70°C
Storage temperature	-40°C to +85°C
Life time (@ 21°C)	@12Vdc (L-version working @ 6Vdc) continuous use min. 100 hours The SMA-21 LV (PIN/SMD) working @ 3Vdc in continuous use: min.24 hours. All tests are made @ 20°C mounted on PCB (expected life time curve in addendum)
Case material	ABS (UL rating: 94 HB) for pin-versions, SMA-13/21/30 PBT (UL rating: 94 HB) for pin versions, SMA-17/24 PPS (UL rating: 94 V0/5V) for SMD-versions, SMA-13/17/21/24/30
Standard colour of case	Grey

ELECTRICAL PARAMETERS

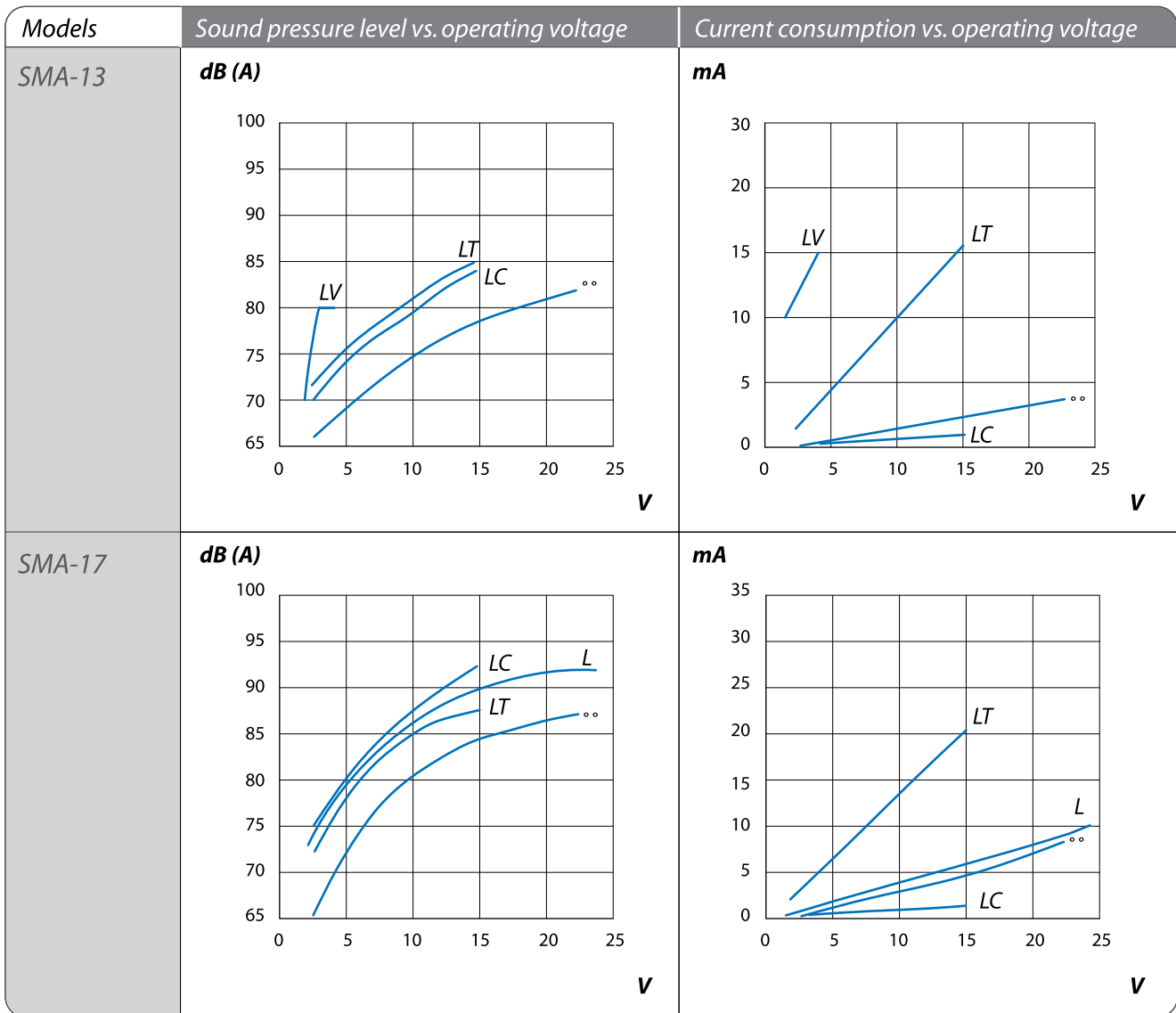

All measurements are made @ 30 cm in free air @ 21°C.
°°: standard versions, respectively SMA-13, SMA-17.

Models	Sound pressure level vs. operating voltage	Current consumption vs. operating voltage
SMA-21	<p>dB (A)</p>	<p>mA</p>
SMA-24	<p>dB (A)</p>	<p>mA</p>
SMA-30	<p>dB (A)</p>	<p>mA</p>

All measurements are made @ 30 cm in free air @ 21°C.
 °°: standard versions, respectively SMA-21, SMA-24, SMA-30.

PRODUCT CODIFICATION

<p>SMA</p> <p>↓</p> <p>Sonitron Multi- Application</p>	<p>I -</p> <p>↓</p> <p>Intermittent</p>	<p>13</p> <p>17</p> <p>21</p> <p>24</p> <p>30</p> <p>↓</p> <p>Square diameter (mm)</p>	<p>L</p> <p>LV</p> <p>↓</p> <p>L: Loud LV: Low voltage</p>	<p>C</p> <p>T</p> <p>↓</p> <p>C: C-MOS T: Transistor</p>	<p>P7.5</p> <p>P10</p> <p>P15</p> <p>P17.5</p> <p>P20.32</p> <p>S</p> <p>↓</p> <p>P: Pin distance (in mm) S: SMD terminals</p>
--	---	--	--	--	--

LIST OF AVAILABLE PRODUCT TYPES

Version	Standard (°°)	Loud (L)	Transistor (LT)	Low Current (LC)	Intermittent (I) (*)	Low Voltage (LV)
SMA-13 series	SMA-13 P7.5 SMA-13 P10 SMA-13 S		SMA-13LT P7.5 SMA-13LT P10 SMA-13LT S	SMA-13LC P7.5 SMA-13LC P10 SMA-13LC S		SMA-13LV P7.5 SMA-13LV P10 SMA-13LV S
SMA-17 series	SMA-17 P7.5 SMA-17 P10 SMA-17 S	SMA-17L P7.5 SMA-17L P10 SMA-17L S	SMA-17LT P7.5 SMA-17LT P10 SMA-17LT S	SMA-17LC P7.5 SMA-17LC P10 SMA-17LC S		
SMA-21 series	SMA-21 P10 SMA-21 P15 SMA-21 P17.5 SMA-21 S	SMA-21L P10 SMA-21L P15 SMA-21L P17.5 SMA-21L S	SMA-21LT P10 SMA-21LT P15 SMA-21LT P17.5 SMA-21LT S	SMA-21LC P10 SMA-21LC P15 SMA-21LC P17.5 SMA-21LC S		SMA-21LV P10 SMA-21LV P15 SMA-21LV S
SMA-24 series	SMA-24 P10 SMA-24 P15 SMA-24 P17.5 SMA-24 P20.32 SMA-24 S	SMA-24L P10 SMA-24L P15 SMA-24L P17.5 SMA-24L P20.32 SMA-24L S			SMAI-24 P10 SMAI-24 P15 SMAI-24 P17.5 SMAI-24 P20.32 SMAI-24 S	
SMA-30 series	SMA-30 P15 SMA-30 P17.5 SMA-30 P20.32 SMA-30 S	SMA-30L P15 SMA-30L P17.5 SMA-30L P20.32 SMA-30L S				

* When the third pin of SMAI-24 is left open, the audible signal is intermittent. When the third pin is connected to the (-), the audible signal is continuous. When the third pin is connected to the (+), there is no sound (=stop).

Order options and packaging information see page 52, 53.

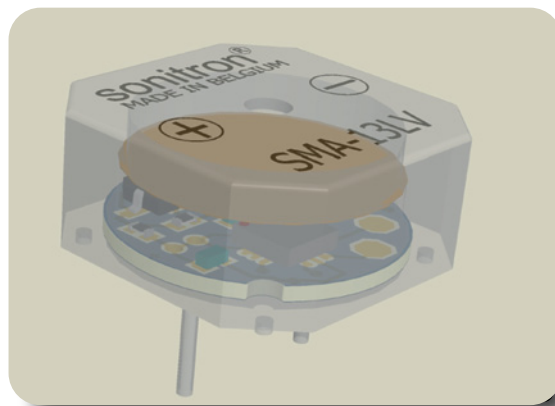

SMAT SERIES



The SMAT transducers are specifically developed to meet various requirements, such as loud sound pressure level, mounting methods, connection possibilities and dimensions. The transducers do not have a built-in oscillator. The drive frequency must be generated with electronics outside the transducer. Recommended drive circuits are described in this catalogue. Our transducers produce a highly reliable audible tone signal, giving either an extremely clear and penetrating tone or a soft sound for non-aggressive signals. They are available in five sizes: 13mm, 17mm, 21mm, 24mm and 30mm.

ADVANTAGES & APPLICATIONS

ADVANTAGES :

- Octagonal form
- Models with different pin pitches
- Light but solid construction
- Not fixed working frequency
- Easily mountable
- SMAT-13 and SMAT-17 for limited space applications
- SMD models with heat resistant labels for protection during re-flow soldering
- Automatic pick & place

APPLICATIONS :

- Alarms
- Gas & metal detectors
- Measuring & weighing equipment
- Medical instrumentation
- Timers & clocks
- Instrumentation & control systems
- Copiers
- Automobiles & trucks
- Games & toys
- Cash registers

SPECIFICATIONS

Model	SPL * (dB(A))	Frequency Range (Hz)	Capacitance (+/-30%) nF)	Operating voltage (VAC pp)	Weight (g)
SMAT-13	See graph	800-5000	7.8	0 to 30	1
SMAT-17	See graph	800-5000	17.5	0 to 30	2
SMAT-21	See graph	600-5000	12.4	0 to 30	2.5
SMAT-24	See graph	400-5000	18.6	0 to 30	4
SMAT-30	See graph	300-5000	25	0 to 30	5

Operating temperature	-20°C to +70°C
Storage temperature	-40°C to +85°C
Life time (@ 21°C)	@12Vpp continuous use at resonance frequency, tested on maximum sound pressure (eg. SMAT-21 @ 3.75 kHz). Life expectations: min.1000 hours. All tests are made @ 20°C mounted on PCB (expected life time curve in addendum).
Case material	ABS (UL rating: 94 HB) for pin-versions, SMAT-13/21/30 PBT (UL rating: 94 HB) for pin versions, SMAT-17/24 PPS (UL rating: 94 V0/5V) for SMD-versions, SMAT-13/17/21/24/30
Standard colour of case	Grey

* All measurements are made in free air @ 21°C @ 30 cm @10 Vpp (square wave). The test buzzer is soldered on a pcb board with dimensions of 24 cm x 11 cm.

ELECTRICAL PARAMETERS

<p>Model</p> <p>Sound pressure vs. frequency</p>	<p>SMAT-13</p> <p>dB (A)</p> <p>kHz</p>	<p>SMAT-17</p> <p>dB (A)</p> <p>kHz</p>
<p>Model</p> <p>Sound pressure vs. frequency</p>	<p>SMAT-21</p> <p>dB (A)</p> <p>kHz</p>	<p>SMAT-24</p> <p>dB (A)</p> <p>kHz</p>
<p>Model</p> <p>Sound pressure vs. frequency</p>	<p>SMAT-30</p> <p>dB (A)</p> <p>kHz</p>	<p>Peak hold frequency sweep from 1 to 8kHz with a square wave signal of 10Vpp. (precision of frequency: +/- 15%)</p>

All measurements are made @ 30 cm in free air @ 21°C.

DRIVE CIRCUITS (typical circuits)

IC Oscillation Circuit

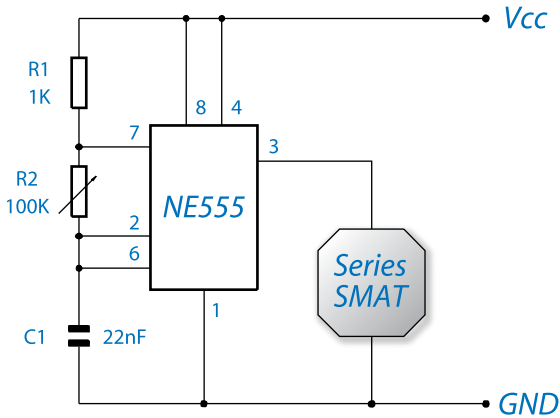

Multivibrator Circuit

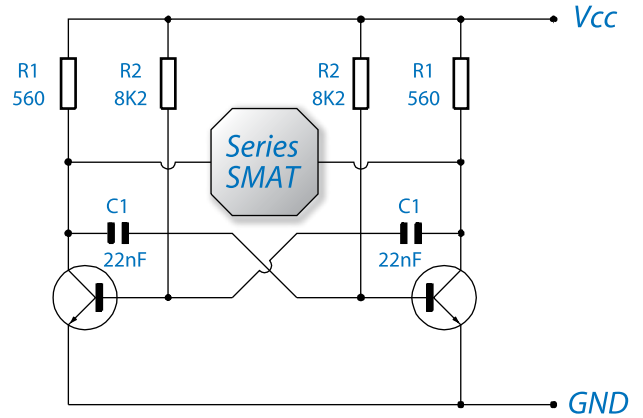

Inverter Oscillator

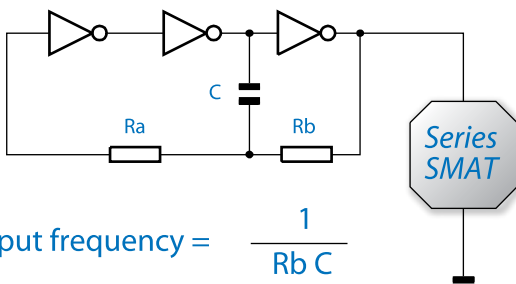

$$\text{Output frequency} = \frac{1}{R_b C}$$

Inverters are CMOS 4049 or 4069

Nandgate Oscillator

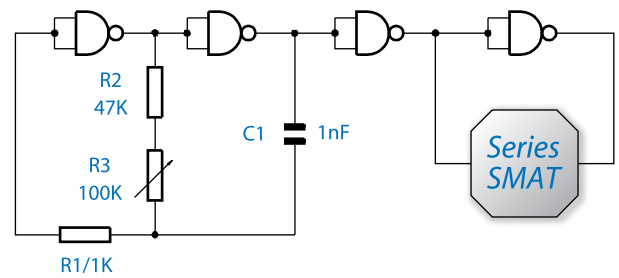

Nandgates are CMOS 4011A

5 Nandgate Oscillator - 3 tones

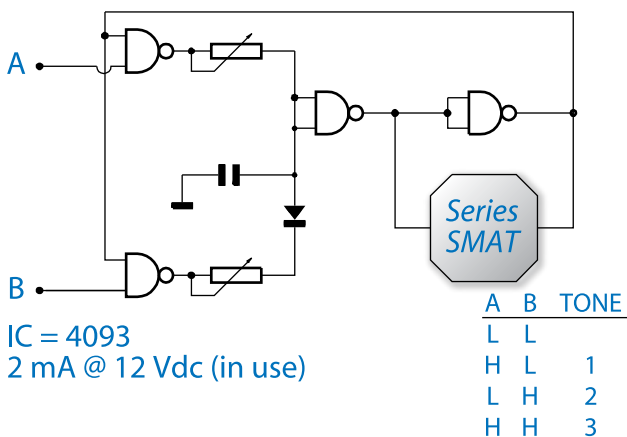

IC = 4093
2 mA @ 12 Vdc (in use)

Tone Generator - CMOS - Gate Multifunction

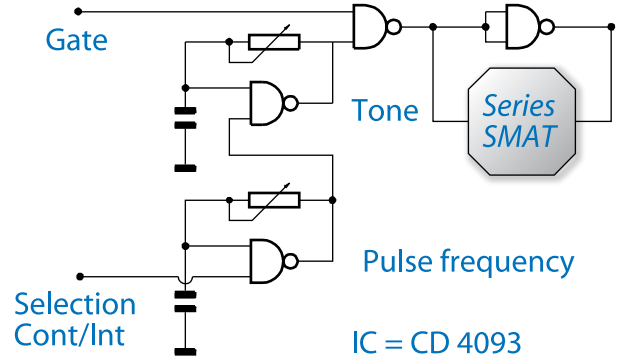

IC = CD 4093

When the transducers are used in a drive circuit at one single frequency, the designer should bear in mind that the precision of the frequency, as mentioned on the graph "sound pressure vs. Frequency" is +/- 15%. We therefore recommend to test the sound pressure level with the transducer connected to the final drive circuit.

PRODUCT CODIFICATION

SMA ↓ ↓ ↓ ↓ ↓	T ↓ ↓ ↓ ↓	13 17 21 24 30 ↓	P7.5 P10 P15 P17.5 P20.32 S ↓
Sonitron Multi- Application	Transducer	Square diameter (mm)	P: Pin distance (in mm) S: SMD terminals

LIST OF AVAILABLE PRODUCT TYPES

SMAT-13 P7.5 SMAT-13 P10 SMAT-13 S	SMAT-17 P7.5 SMAT-17 P10 SMAT-17 S	SMAT-21 P10 SMAT-21 P15 SMAT-21 P17.5 SMAT-21 S	SMAT-24 P10 SMAT-24 P15 SMAT-24 P17.5 SMAT-24 P20.32 SMAT-24 S	SMAT-30 P15 SMAT-30 P17.5 SMAT-30 P20.32 SMAT-30 S
--	--	--	--	---

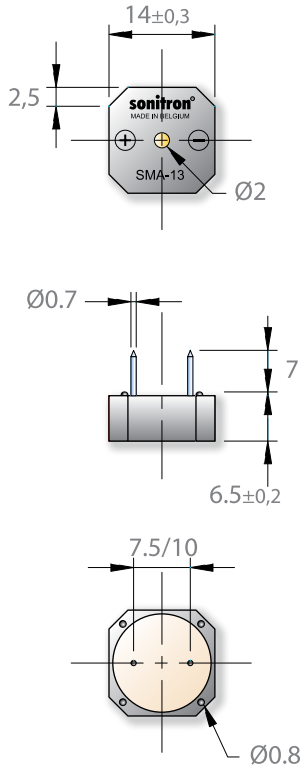
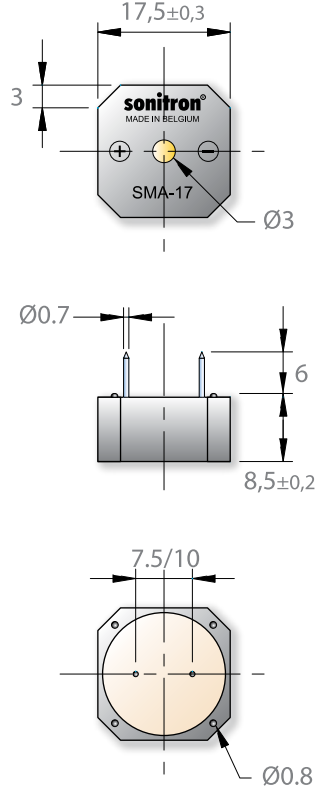
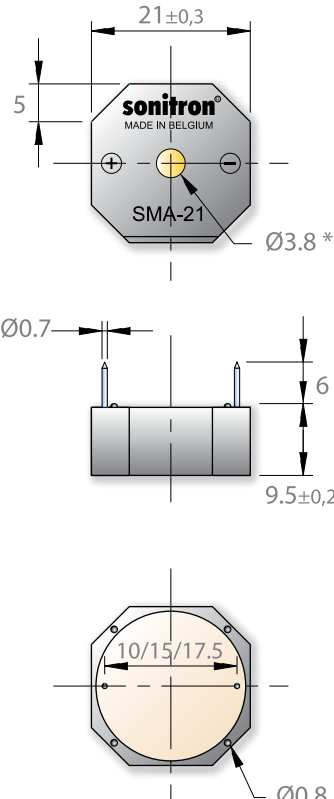
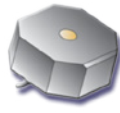
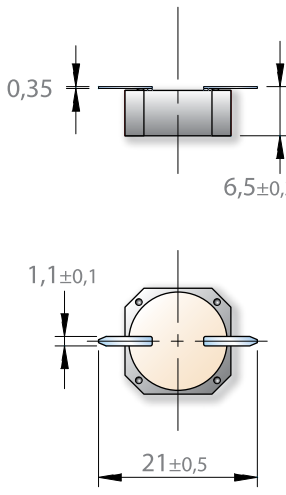
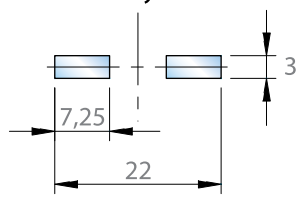
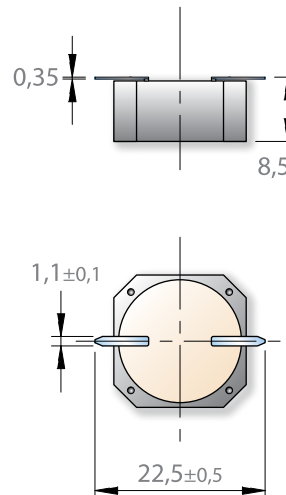
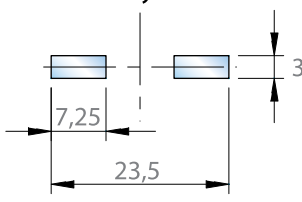
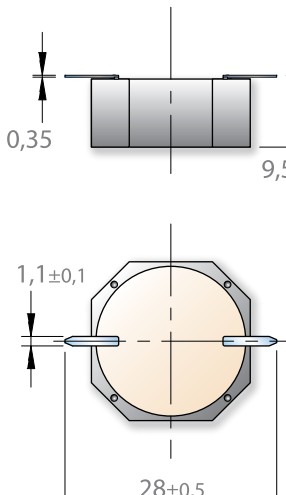
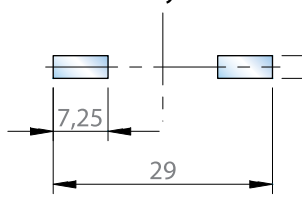

DIMENSIONS SMA & SMAT-SERIES (All dimensions are in mm)

<p>Pin version</p> 	<p>SMA(T)-13</p> 	<p>SMA(T)-17</p> 	<p>SMA(T)-21</p> 
<p>SMD version</p> 	 <p>Recommended PCB lay-out</p> 	 <p>Recommended PCB lay-out</p> 	 <p>Recommended PCB lay-out</p> 

* The sound hole of SMA-21 LV has a diameter of 3 mm, whereas the other SMA-21 types have a 3,8 mm sound hole.

(All dimensions are in mm)

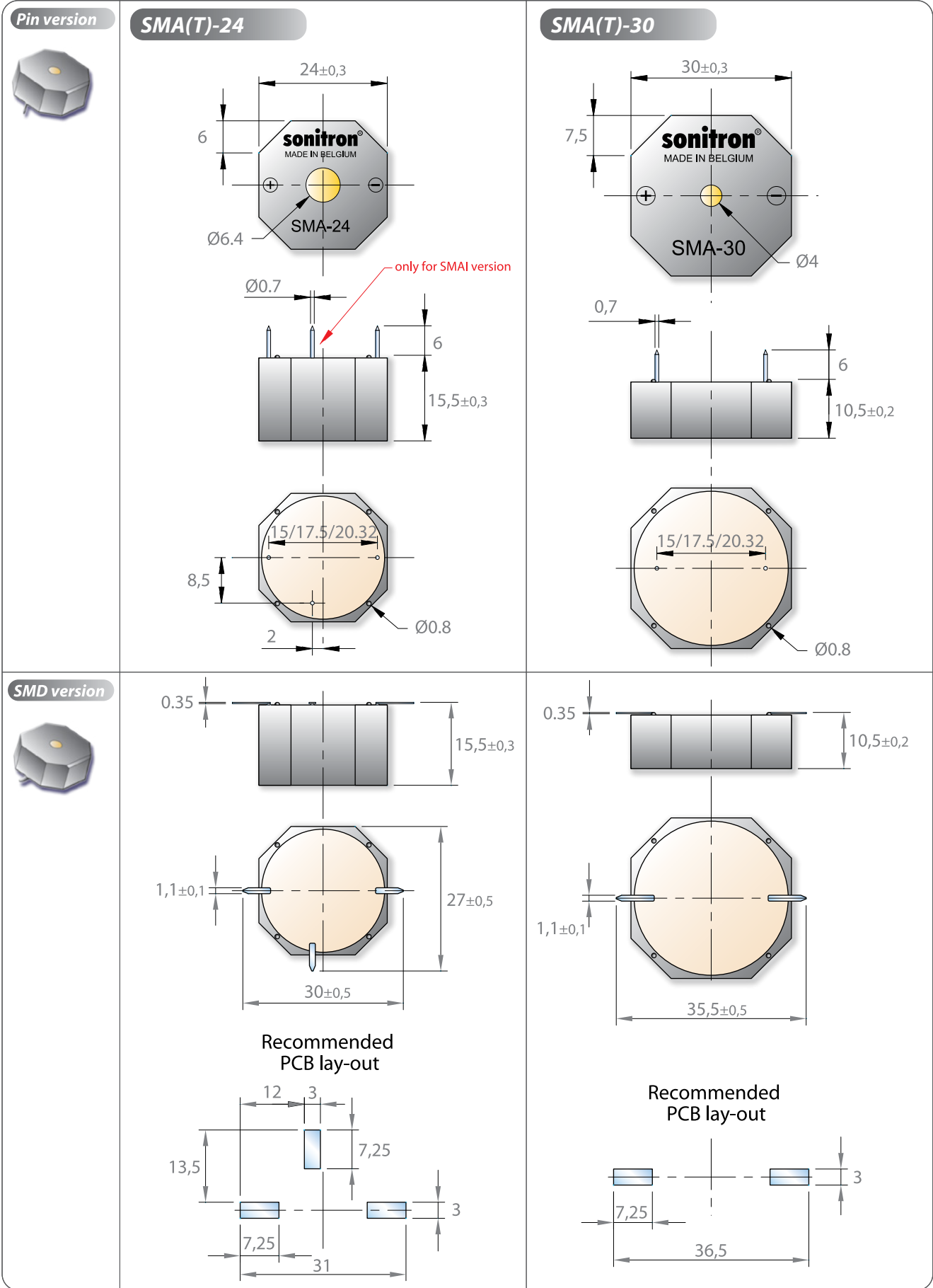

MOUNTING POSSIBILITIES FOR THE SMA & SMAT SERIES

Soldered with pins on the PCB

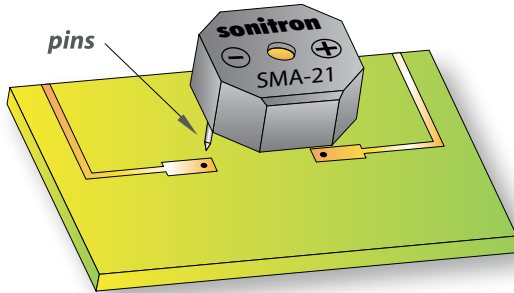

SMD soldered on the PCB

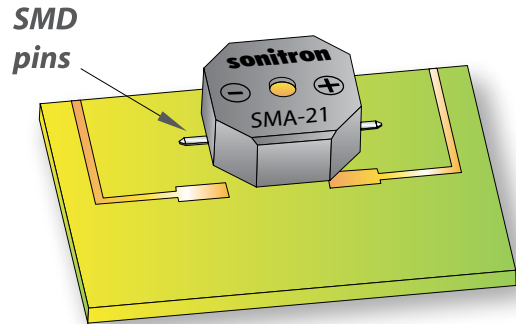

PRODUCT OPTIONS SMA & SMAT SERIES

Option Code	example	Description
SP01	SMAT-21-P10/SP01	Contains heavy duty wires (plastic insulation) <i>(only for SMA(T)-21 and SMA(T)-24)</i>
SP02	SMAT-21-P17.5/SP02	Contains heavy duty wires (plastic insulation), connection sealed with silicone <i>(only for SMA(T)-21, SMA(T)-24)</i>
SP04	SMA-13LC-S/SP04	The PCB of the buzzer/transducer is secured with epoxy-adhesive
SP05	SMA-24L-P17.5/SP05	Extended frequency control (only SMA series)
Wash Tab	SMAT-13-P7.5 +Wash Tab	Recommended for automatic washing production process. The PCB is secured with epoxy-adhesive+ wash tab upon the sound-emitting hole, avoiding liquid penetration into the cavity. TO BE REMOVED AFTER the washing process for good sound output!!!
MC	SMAT-13-P10-MC	Acryl coating (Membrane Coating). Recommended for aggressive, humid or smoggy environment.
FP13 FP13SR FP17 FP17SR FP21 FP24 FP30		7 different Foam Patches are available to cover the SMA(T) series for extra acoustic and mechanical stabilization. See page 38, 39

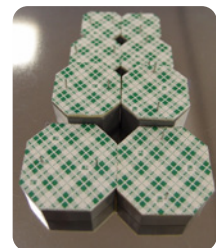

To order an option add the suffix to the model number of the SMA(T)-series.

Capton A heat protection label standard for all SMD buzzers, in capton material glued on the SMD model of the SMA(T) buzzer. This enables the user to pick up the buzzer by vacuum.
During the re-flow soldering process the heat shield label remains on the buzzer and must be removed after soldering.

PACKAGING SMA & SMAT-SERIES

All models with pin terminals are put on a polystyrene board (245 L x 245 W) and sold in boxes with dimensions 250 L x 250 W x 125 H.

Number	SMA(T)-13 series	SMA(T)-17 series	SMA(T)-21 series	SMA(T)-24 series	SMA(T)-30 series
per board	250	150	100	100	64
per box	(8x250) 2000	(6x150) 900	(5x100) 500	(5x100) 500	(6x64) 384

All SMD models are packed in trays (245 L x 245 W) and sold in boxes with dimensions 250 L x 250 W x 125 H.

Number	SMA(T)-13 S	SMA(T)-17 S	SMA(T)-21 S	SMA(T)-24 S	SMA(T)-30 S
per board	100	81	49	42	25
per box	(9x100) 900	(8x81) 648	(7x49) 343	(5x42) 210	(6x25) 150

Dimensions of the tray and position of the SMD components:

Model	A	B
SMA(T)-13-series	22 mm	16 mm
SMA(T)-17-series	24 mm	18 mm
SMA(T)-21-series	30 mm	16.7 mm
SMA(T)-24-series	35 mm	22.6 mm
SMA(T)-30-series	36 mm	19 mm

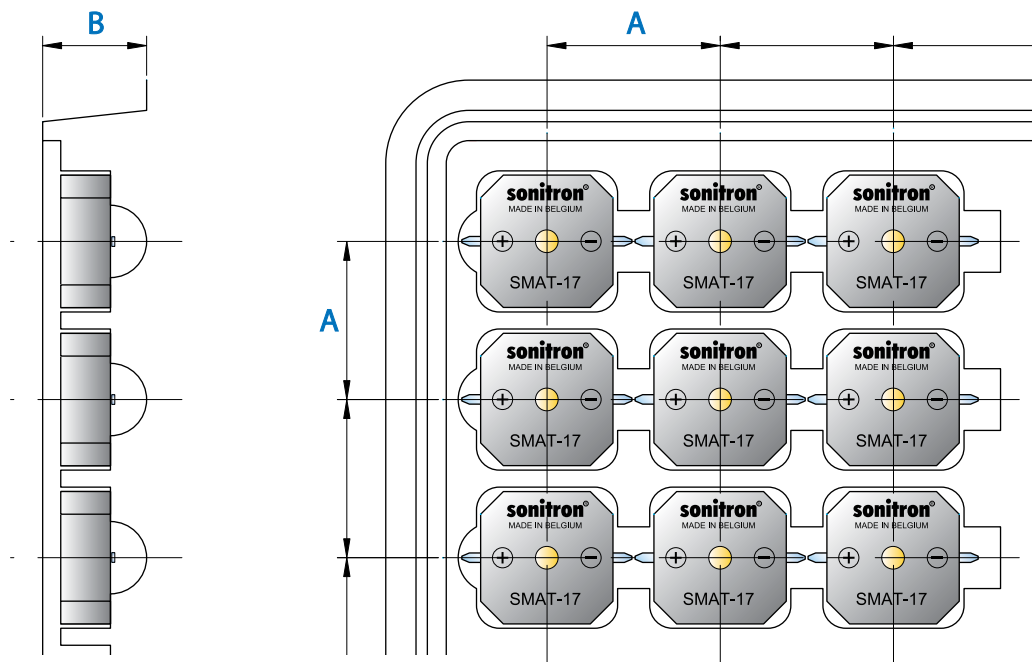

SMB SERIES



INTRODUCTION

Audible signals are part of our daily life. More sophisticated and distinctive functions are required for industrial purposes. The choice of the frequencies is simply done by changing the capacitor value in a C-MOS driven circuit.

Our SMB-series (multi-frequency buzzers) offer the possibility to program several different frequencies. These audible signals with multi-frequency programmability will become an important component that must be considered in every design of equipment, machines, household equipment, computers, communication equipment, control panels, etc.

ADVANTAGES & APPLICATIONS

ADVANTAGES :

- Low cost
- Solid state reliability
- No EMC
- Very low current consumption
- Panel and PCB mountable
- Free programmable
- Easy integration in existing circuits
- Small dimensions
- Thin profile

APPLICATIONS :

- Automobiles & trucks
- Trains
- Office equipment
- Telephone equipment
- Toys & games
- Clocks & timers
- Alarms
- Instrumentation
- Control panels
- Medical equipment
- Video conference system
- Answering machine
- Automatic door



SPECIFICATIONS

All three multi-frequency buzzers have several peak frequencies, either producing alerting tones at high frequencies or soft signals at low frequencies down to 100 Hz (see the typical application description). The diversity in use of the three models is limited only by your imagination. The current consumption is extremely low and starts @ only 100 μ A with a maximum of 4.8 mA @ maximum 15 Vdc.

Model	SPL (dB(A))	Frequency ($\pm 15\%$ Hz)	Peak frequencies SPL **	Operating voltage (Vdc)	*Operating current (mA)	Weight (g)
SMB-17CC	See graph	See graph	2250 Hz-79 dB(A) 1670 Hz-71 dB(A) 785 Hz-69 dB(A) 325 Hz-64 dB(A)	1.5 to 15	0.2 to 1.4	2
SMB-32CC	See graph	See graph	2250 Hz-76 dB(A) 1260 Hz-89 dB(A) 785 Hz-68 dB(A) 325 Hz-66 dB(A)	1.5 to 15	0.2 to 2.7	8

Operating temperature	-40°C to +85°C
Storage temperature	-40°C to +85°C
Life time (@ 21°C)	See life time cycle in addendum
Case material	PBT (UL rating: 94 HB) for pin-versions PPS (UL rating: 94 V0/5V) for SMD-versions
Standard colour of case	Black

* The current consumption decreases when the frequency is lowered. See graph 'Current consumption vs. Frequency'.

** The given sound pressure values are measured @ 12 Vdc @ 30 cm distance in free air and have an accuracy of $\pm 15\%$. Default factory setting of the SMB models: continuous tone

ELECTRICAL PARAMETERS

Current consumption vs. frequency

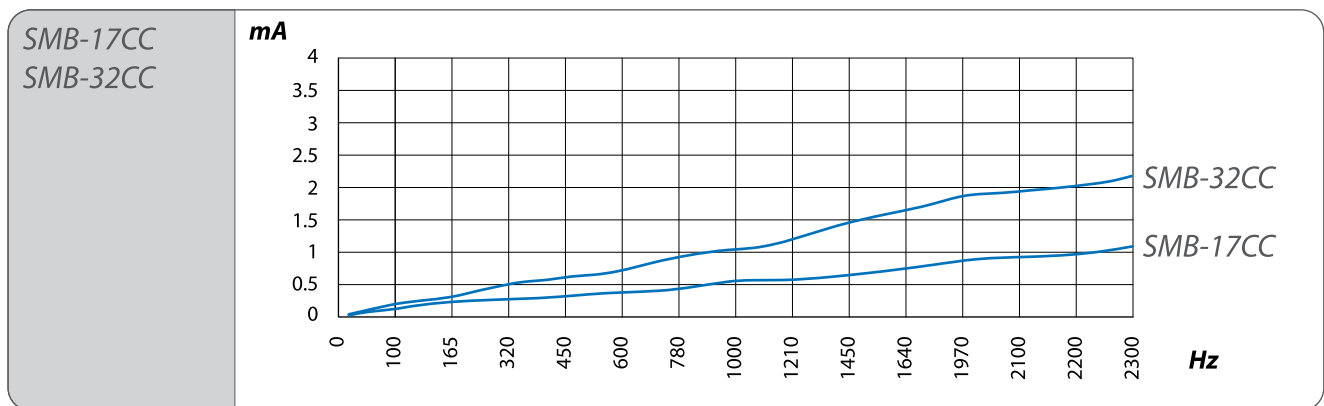

All measurements are made in free air @ 21°C @ 30 cm @ 12 Vdc.

Frequency vs. external capacitor (c)

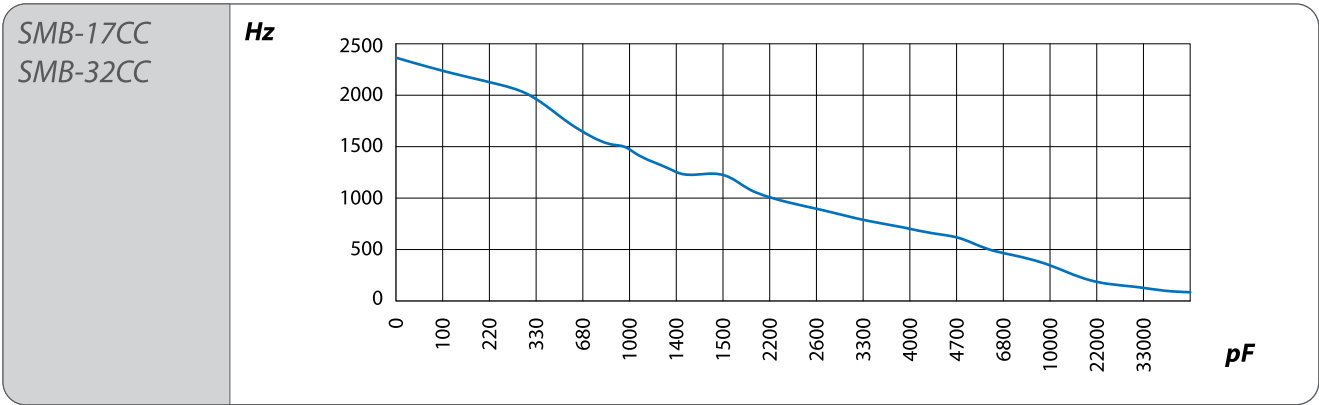

Sound pressure level vs. external capacitor (c)

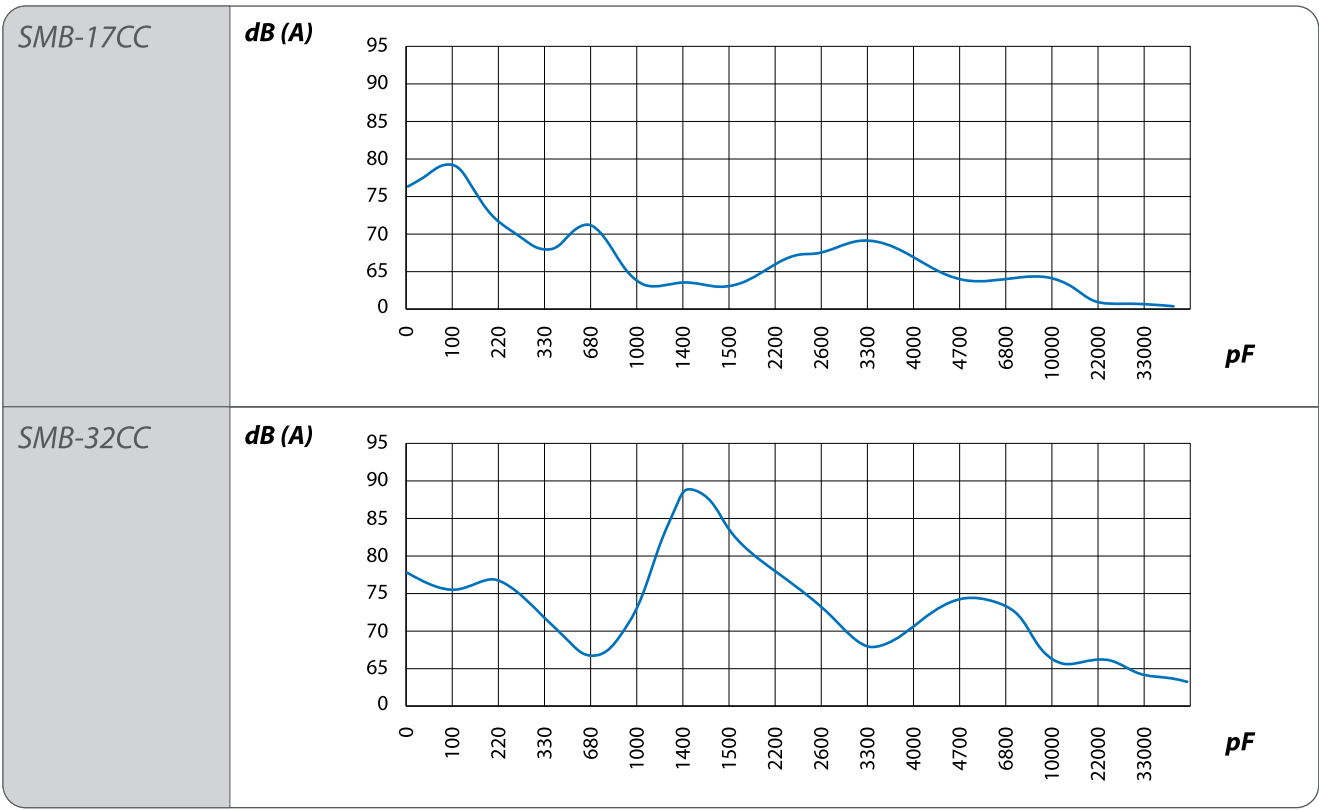

All measurements are made in free air @ 21°C @ 30 cm @ 12 Vdc.

PRODUCT OPTIONS

Option Code	example	Description
FP13	SMB-17CC-P10-FP	Acoustic stabilization Foam Patch, easy to stick. For: SMB-17CC-P10
FP24	MB-32CC-S-FP	Acoustic stabilization Foam Patch, easy to stick. For: SMB-32CC-P10 SMB-32CC-S

DIMENSIONS (All dimensions are in mm)

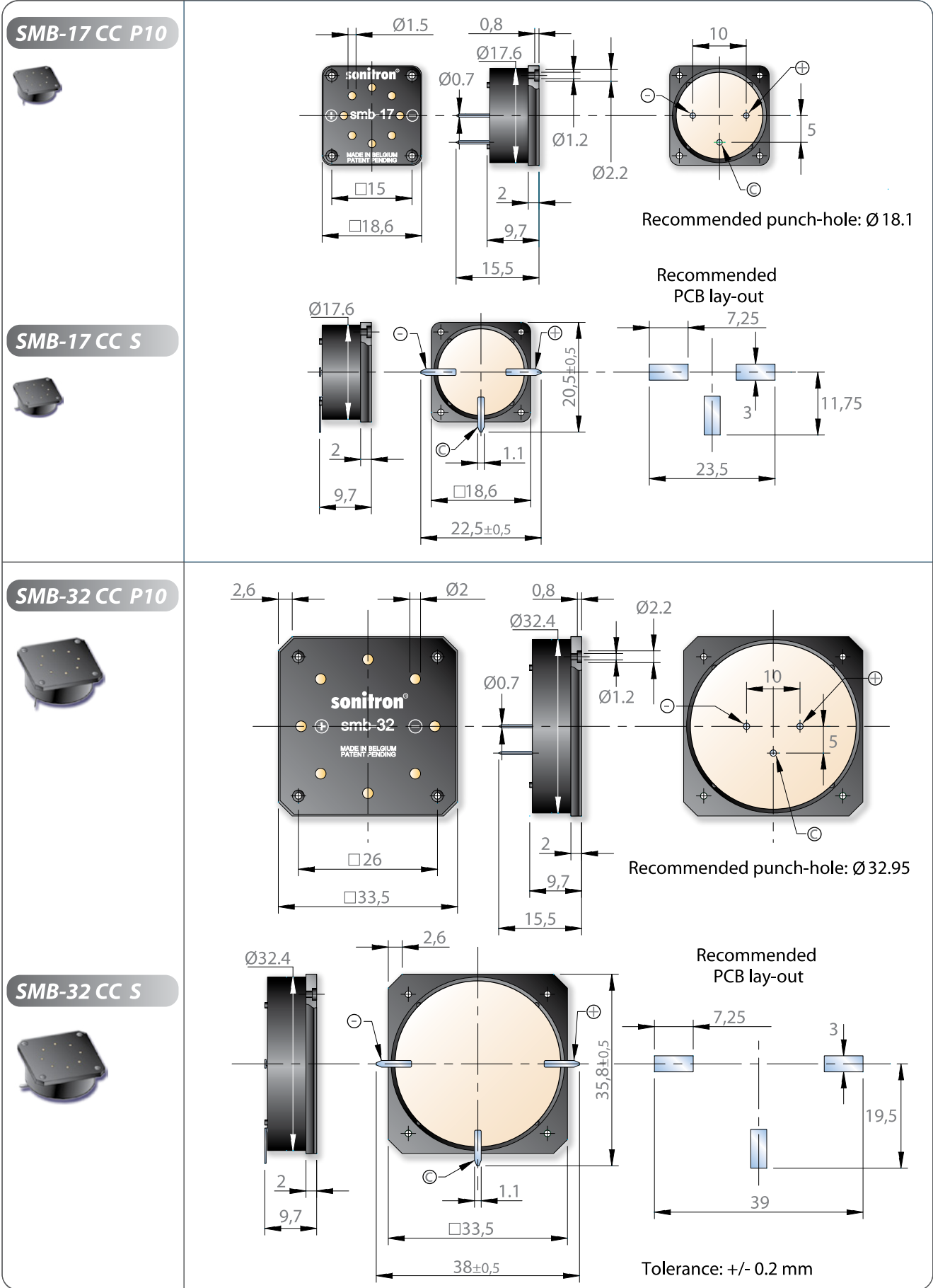

WORKING PRINCIPLE

In order to realise different frequencies with the SMB multi-frequency buzzers, the customer should simply connect a capacitor between the control pin and the ground. It is also possible to disable the SMB, by putting a resistor (47K) to the ground (INHIBIT).

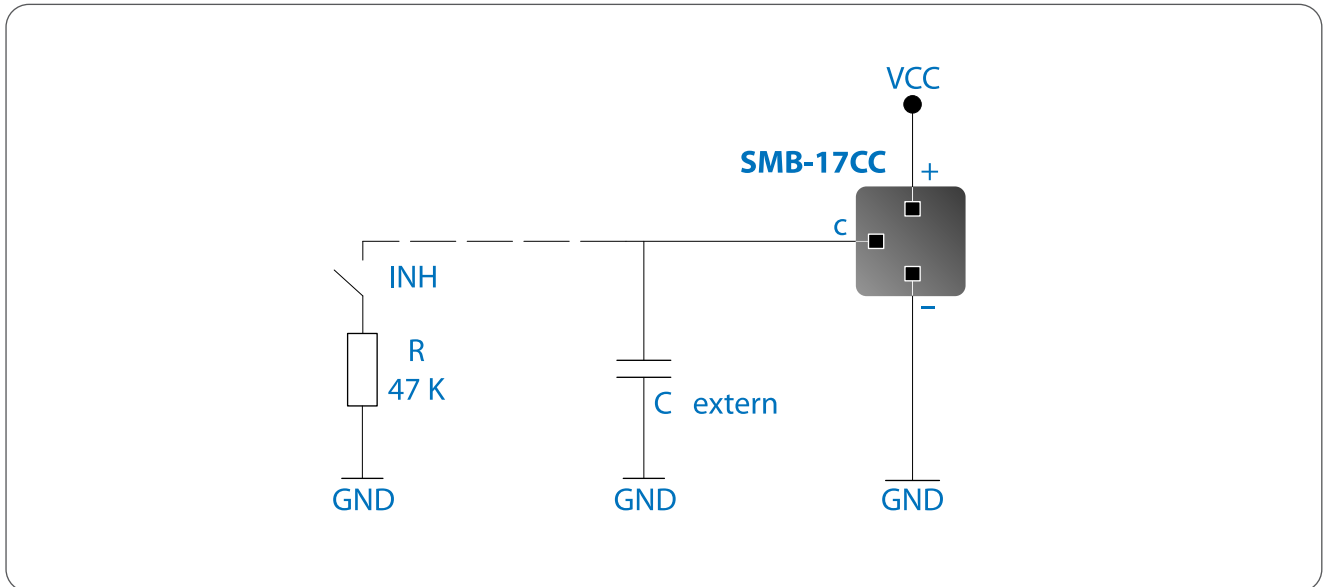

TYPICAL APPLICATION DESCRIPTION

With the circuit shown below, 16 possible frequencies can be generated. The values of C1, C2, C3, ... with their respective frequencies are given in the graph 'Frequency vs. external capacitor'.

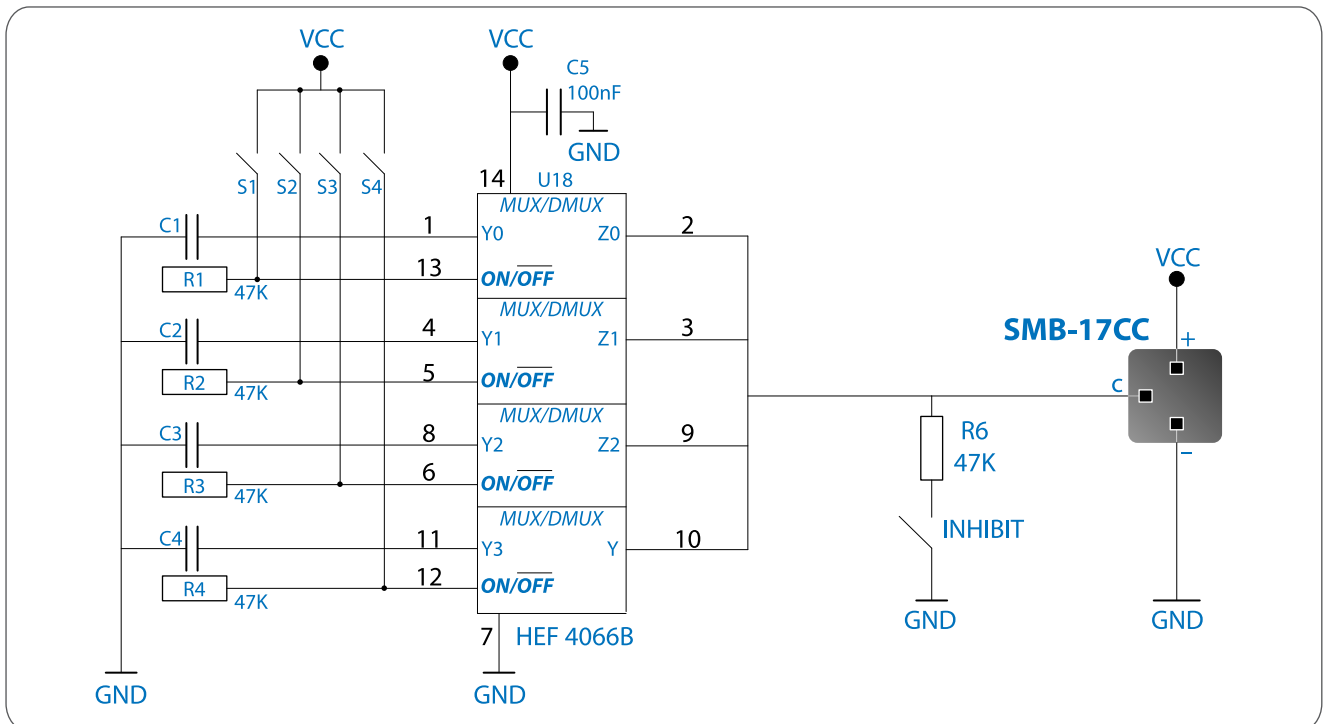

This typical application description is not limited to the typical components we have illustrated. Many other possibilities exist to select and switch the capacitors and/or the resistor.

PRODUCT CODIFICATION

<p>SMB</p> <p>↓</p> <p>Sonitron Multi-Frequency Buzzer</p>	<p>17 32</p> <p>↓</p> <p>Square diameter (mm)</p>	<p>C</p> <p>↓</p> <p>C-MOS</p>	<p>C</p> <p>↓</p> <p>Control pin</p>	<p>P10 S</p> <p>↓</p> <p>P: Pin distance (in mm) S: SMD terminals</p>
--	---	--------------------------------	--------------------------------------	---

LIST OF AVAILABLE PRODUCT TYPES

<p>SMB-17CC P10 SMB-17CC S</p>	<p>SMB-32CC P10 SMB-32CC S</p>
------------------------------------	------------------------------------

PACKAGING

All multi-frequency buzzers with through hole pins, are packed on a polystyrene board (245 L x 245 W) and sold in boxes with dimensions of 250 L x 250 W x 125 H.

Number	SMB-17CC P10	SMB-32CC P10
per board	100	49
per box	(5x100) 500	(5x49) 245

All SMD models are packed in trays (245 L x 245 W) and sold in boxes with dimensions of 250 L x 250 W x 125 H.

Number	SMB-17CC S	SMB-32CC S
per tray	49	25
per box	(8x49) 392	(6x25) 150

Dimensions of the tray and position of the SMD components of the models SMB-17CC S and SMB-32CC S are illustrated below:

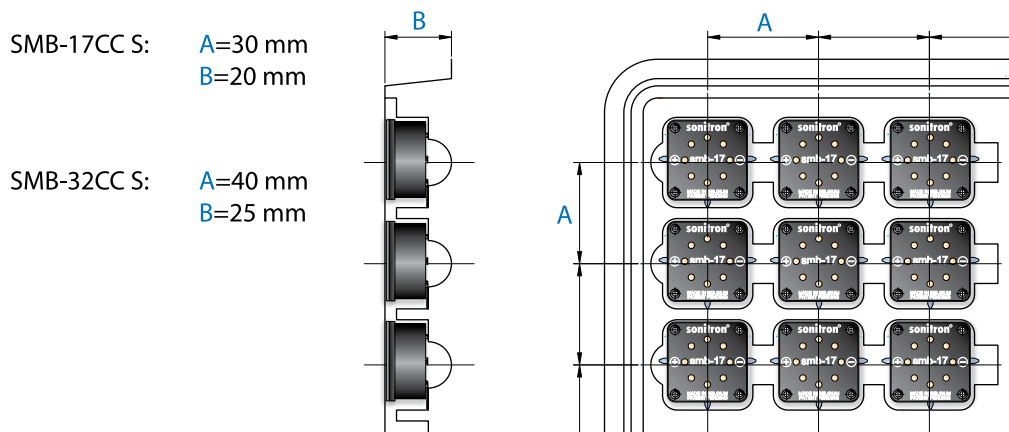

ALARMS SIRENS

SAP Series

SAS Series

SMAC Series

SXL Series

SDS Series



KEY QUESTIONS FOR ALARM DETERMINATION

1. Mounting method:
e.g. Vertical, horizontal ?

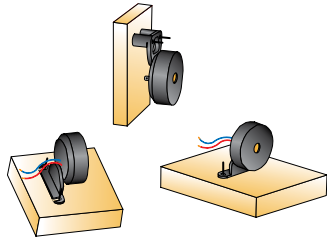

2. Connection method: wires, pins, fast-on terminals ?

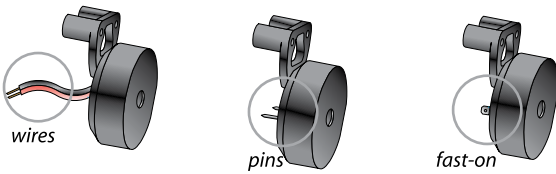

3. Maximum dimensions (in mm):
length, width, depth ?

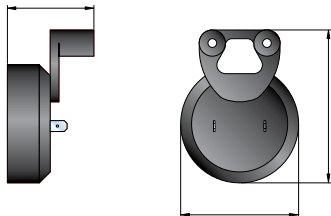

4. Supply voltage: 6, 12 or 24 Vdc ?



5. SPL – dB(A) @ 12Vdc,
@ 30 cm or 1 meter ?

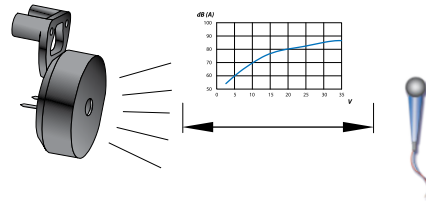

6. Operating frequency range ?

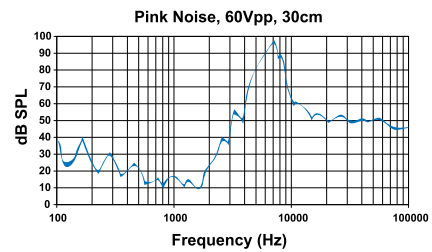

7. Current consumption in mA ?

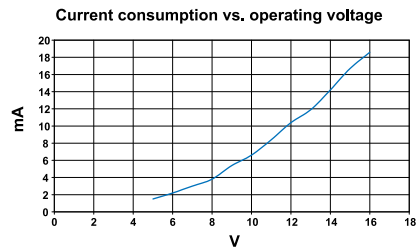

8. Temperature range in °C ?

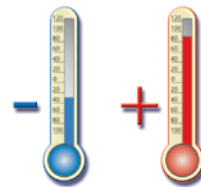

GENERAL OVERVIEW ALARMS & SIRENS

Model	Function	Operating voltage		Frequency (Hz) (±30%)	Operating current (mA)	Sound pressure level* (dB(A))	Weight (g)
		min Vdc	max Vdc				

SAP series



SAP-1302-A	intermittent	12	24	1600	70	112	230
SAP-1302-B	intermittent	12	24	1600	65	107	230
SAP-1302-C	intermittent	12	48	1250	145	97	210
SAP-1302-D	intermittent	12	12	2500	15	87	230

measurement @12-24V @ 1.2 m

SAS series

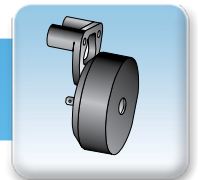

SAS-2155-S	sweep	6	15	2000-3500	120	110	67
SAST-2155	Transducer	-	-	2000-3500	-	-	67

measurement @12V @ 1 m

SMAC(I) series



SMAC-25	continuous	5	16	3350	9.7	93.5	7.8
SMACI-25	intermittent	5	16	3350	9.7	93.5	7.8
SMAC-25L	continuous	5	35	3350	17	100	8.5
SMACT-25	Transducer	-	-	3000-4000	-	-	7.8

measurement @12V @ 30 cm

SXL series

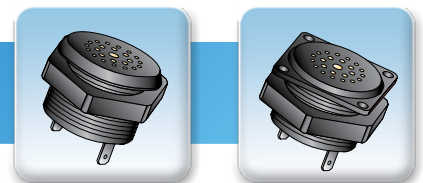

SXLC 515 C	continuous	5	15	3000	130	102	22
SXLI 515 C1	multifunction	5	15	3000	70	96	22
SXLW 515 C	warbler	5	15	3000	120	104	22
SXLP 515 C	sweep	5	15	3000	110	102	22

measurement @12V @ 1 m

Sonitron Automotive Piezo components

SAP-1302 series *Back up alarm*

The 1302 series of piezo alarms generate an acoustic intermittent loud tone and are installed at the back of a car, truck, tractor, jeep, golf-trolley, ... or any other vehicle that can move in reverse at any moment, thus alerting people that are approaching the vehicle.

The 1302 series are tested for use in all weather conditions and have a lifetime in continuous use of more than **1000 hours**, this unique patented technology is used now for more than 20 years in the most extreme conditions and critical applications. (Nato, Airbus, Volvo, avionics, Bombardier railways, VDO, etc...)

A very low current consumption permits the electrical connection of the alarm to the reversing lights of the vehicle.

Installation of the reverse drive piezo alarm is realised in only one hour by anybody and does not require special skills. Adapted mounting for models on request.

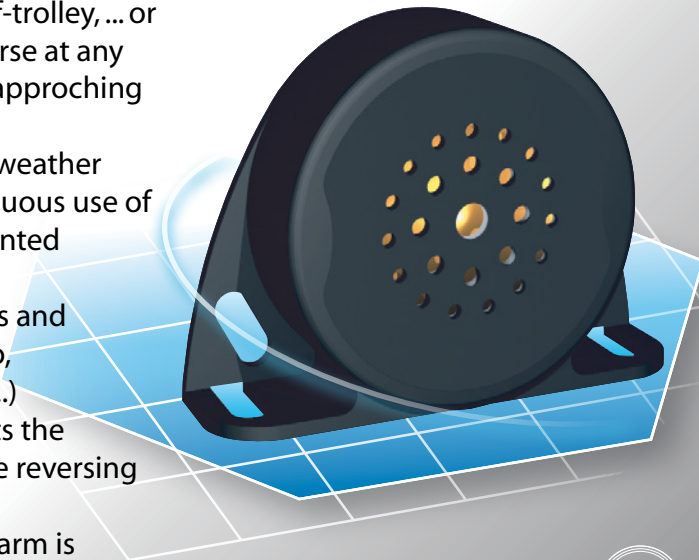

Automotive Design



ADVANTAGES & APPLICATIONS

ADVANTAGES :

- Very low current consumption
- Dust tight, shock and water resistant (IP67)
- Low frequency (large travelling distance of audible wavelength)
- No magnetic field (EMC)
- Robust fibre reinforced PBT housing
- High lifetime in continuous function
- Easy mountable design
- Multi voltage application (12/24/48Vdc)

APPLICATIONS :

- Van
- Fork-lift
- Lorry
- Bus
- Light commercial vehicle
- Car
- Light truck
- Garbage truck
- Electric vehicles (golf, airport, warehouse, ...)
- Military vehicles

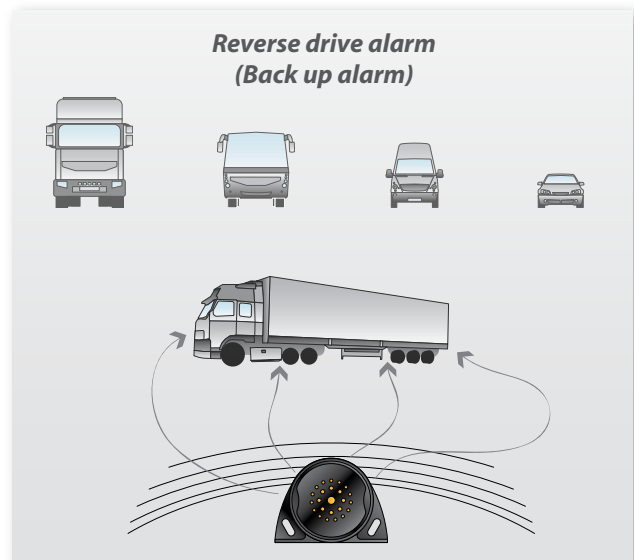

SPECIFICATIONS



MODELS	SAP-1302-A	SAP-1302-B	SAP-1302-C	SAP-1302-D
Operating voltage:	12/24 Vdc	12/24 Vdc	12/24/48 Vdc	12 Vdc**
Frequency (+/-15%):	1600 Hz (1Hz intermittent)	1600 Hz (1Hz intermittent)	1250 Hz (1Hz intermittent)	2500 Hz (1Hz intermittent)
Current consumption:	12Vdc: 145 mA (avg.) 24Vdc: 70 mA (avg.)	12Vdc: 140 mA (avg.) 24Vdc: 65 mA (avg.)	145 mA (avg.)	15 mA (avg.)
SPL@1.2m:	112 dBA (+/- 4 dB)	107 dBA (+/- 4 dB)	97 dBA (+/- 4 dB)	87 dBA (+/- 4 dB)
Life time (@21°C):	>1000 hours***	>1000 hours***	>1000 hours***	>1000 hours***
Case material:	PBT (UL rating: 94HB)	PBT (UL rating: 94HB)	PBT (UL rating: 94HB)	PBT (UL rating: 94HB)
Standard color of case:	Black	Black	Black	Black
Terminal material:	(F2)Fast-on or 30cm cable 2x1.5mm ²	(F2)Fast-on or 30cm cable 2x1.5mm ²	(F2)Fast-on or 30cm cable 2x1.5mm ²	(F2)Fast-on or 30cm cable 2x1.5mm ²
Storage Temp. range:	-40°C/+85°C	-40°C/+85°C	-40°C/+85°C	-40°C/+85°C
Operating Temp. range:	-40°C/+85°C	-40°C/+85°C	-40°C/+85°C	-40°C/+85°C
Weight:	230 g	230 g	210 g	230 g

- **Output voltage depending: min. 5 Vdc=76 dBA, max. 16Vdc=91 dBA.
- ***Lifetime: more than 1000 hours in continuous use,
(Voltage: 12 Vdc ; T ambient: 21°C ; Humidity: 40 % ; Free air).

"Models on request" can be designed for this alarm construction!
 Same housing other alarm tone: - pulse tone
 - continuous tone
 - sweep tone, ...
 Contact Support@sonitron.be



Sound pressure level vs. operating voltage

SAP-1302-A

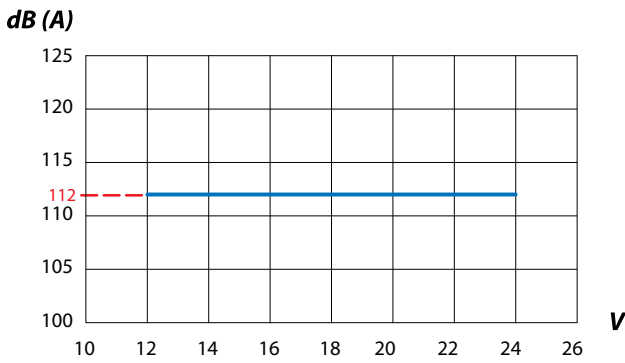

SAP-1302-B

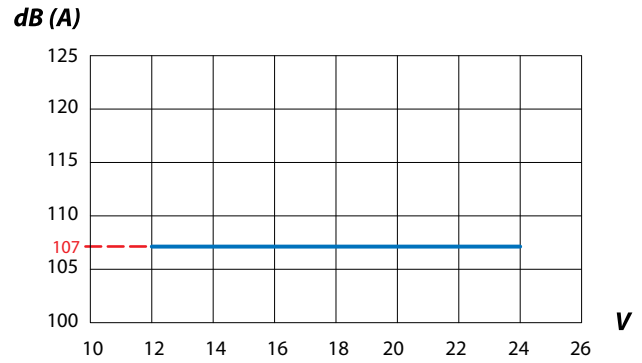

SAP-1302-C

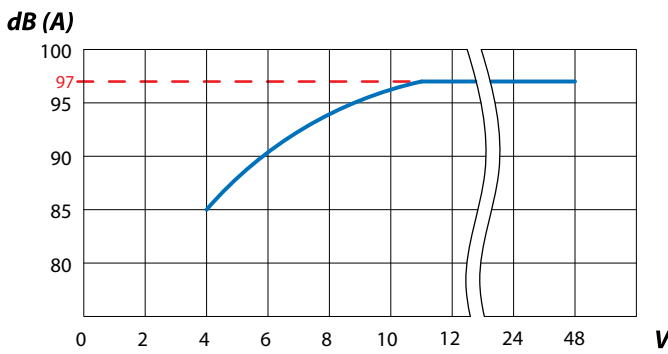

SAP-1302-D

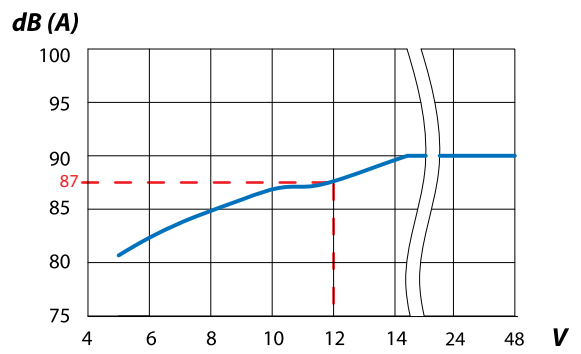

All measurements are made @ 12Vdc @1.2 meter in free air @ 21°C.

LIST OF AVAILABLE PRODUCT TYPES

SAP-1302-A-F2	(Fast-on F2, tinned brass)
SAP-1302-A-W	(standard cable lenght=30cm)
SAP-1302-B-F2	(Fast-on F2, tinned brass)
SAP-1302-B-W	(standard cable lenght=30cm)
SAP-1302-C-F2	(Fast-on F2, tinned brass)
SAP-1302-C-W	(standard cable lenght=30cm)
SAP-1302-D-F2	(Fast-on F2, tinned brass)
SAP-1302-D-W	(standard cable lenght=30cm)

Dimensions (in mm)

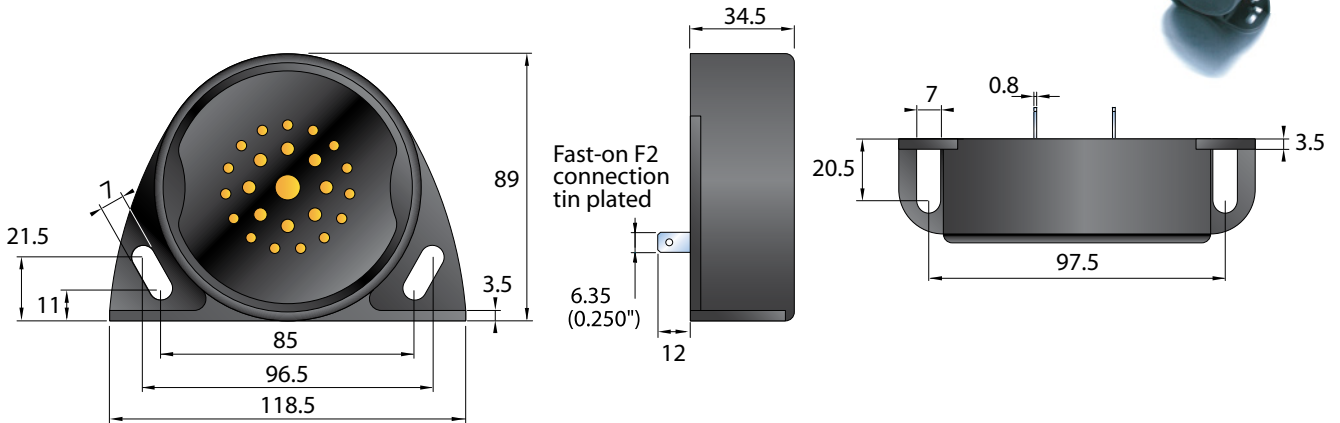

SAP-1302-A-B-C
Fast-on position

Cable version
Standard cable length: 30 cm

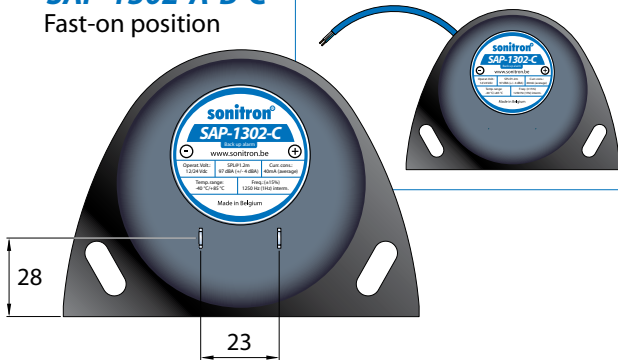

SAP-1302-D
Fast-on position

Cable version
Standard cable length: 30 cm

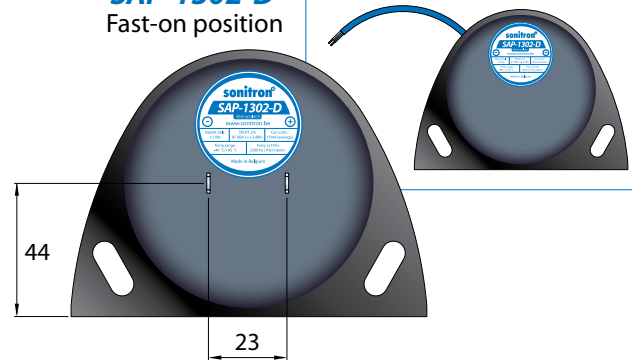

Mounting guidelines

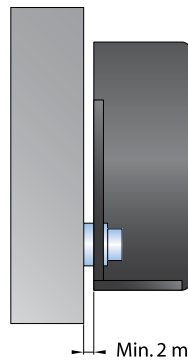
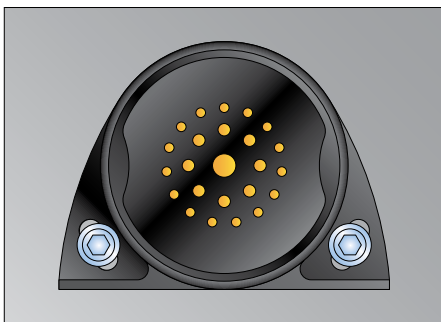

2x M6 screw, nut and washer recommended for mounting

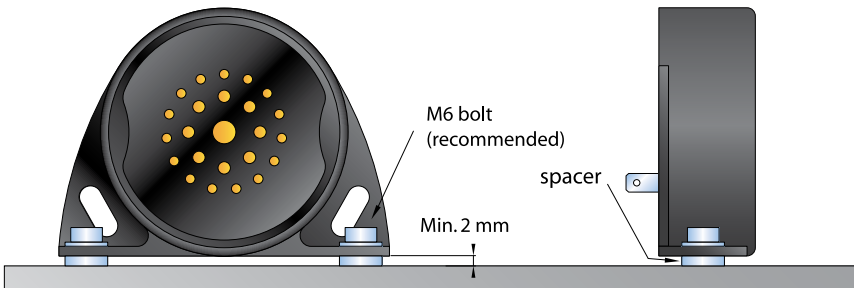

Packaging

One piece per box.



SAS SERIES



INTRODUCTION

Sonitron **A**larms **S**eries are developed for a temperature range of -40°C to $+85^{\circ}\text{C}$. Small designs and very loud output are the main characteristics of this piezo series. Different models are developed for use in applications where dimensions should be small and sound output loud, such as fire alarms, security devices,...etc.

ADVANTAGES & APPLICATIONS

ADVANTAGES :

- Loud siren output with high sound pressure level
- Dust tight, waterproof (IP67)
- Low current consumption
- No magnetic field

APPLICATIONS :

- Car alarm
- Fire alarm
- Motor alarm
- Home security alarm



SAS-2155 PIEZO SOUNDER

2000 to 3000 Hz



The SAS-2155 is a thin piezo electric siren with high sound pressure, low weight and low current consumption. The sound output is a powerful, clear and less aggressive sweep signal. There are many applications for this siren: all fire alarms, cars and motor vehicles, automation equipment, security devices, etc. The vibrating elements are unique and developed at Sonitron (worldwide patented). This series is made from high quality materials, offers extreme reliability and robustness, and features life time over 2000 hours in continuous use.

SPECIFICATIONS



Model	Function	Sound pressure level (dB(A)(±2dB(A))	Frequency (Hz)(±30%)	Operating voltage (Vdc)	Operating*** DCcurrent(mA)
SAS-2155-S	Sweep	102	2000 to 3000**	6-15	100

** Interval frequency is 3Hz (± 2Hz).

*** Operating current @12Vdc

Operating temperature:	-40°C to +85°C
Storage temperature:	-40°C to +85°C
Expected life time:	2000 hours continuous working @12Vdc @21°C @35% RH
Color:	grey, black
Terminals:	pins, fast-on and wire connection
Case material:	Standard ABS plastic (UL rating: 94HB) Akulon plastic on request
Weight:	35g
Mounting method:	Mounting on panels and walls with universal bracket

ELECTRICAL PARAMETERS

Model	Current consumption vs. operating voltage	Sound pressure level vs. operating voltage
SAS-2155-S	<p>mA</p>	<p>dB (A)</p>

Note : All measurements are made in free air @1 meter @21°C @35% RH. For measurement purposes, the alarm was mounted with mounting bracket "MB1" on a wooden panel.

SAST-2155 PIEZO TRANSDUCER

2000 to 3000 Hz



The SAST-2155 is a transducer version of the SAS-2155-S. The drive electronics are not included on the internal pcb and must be created by the customer to realize a good functional sound output. The maximum dB(A) level is obtained if the drive frequency is used between 2kHz and 3kHz. Several signals can be combined or produced in continuous, intermittent, warbler or sweep mode. Square wave signals give extra sound dimensions because of their harmonic content.

The SAST-2155 is available with connections in pins, Fast-ons or wires. The casing is standard in UL94HB ABS plastic but can be obtained in Akulon plastic on request. For Fast and strong mounting on a wall, several mounting brackets are available.

When the maximum voltage peak to peak signal of 40Vpp square wave is respected a life time over 2000 hours can be obtained in continuous use.

This transducer is the best product for the realization of your personalized alarm or siren driven by customers electronics.

SPECIFICATIONS

Model	SPL * (dB(A))	Frequency Range (Hz)	Capacitance (+/-30%) nF	Operating voltage (VAC pp)	Weight (g)
SAST-2155	See graph	2000 - 3000	75 nF	0 to 40	35g

Operating temperature:	-40°C to +85°C
Storage temperature:	-40°C to +85°C
Expected life time:	2000 hours continuous working
Color:	grey, black
Terminals:	pins, fast-on and wire connection
Case material:	Standard ABS plastic (UL rating: 94HB) Akulon plastic on request
Max. SPL	+/- 100dB(A) @100cm
Mounting method:	Mounting on panels and walls with universal bracket

ELECTRICAL PARAMETERS

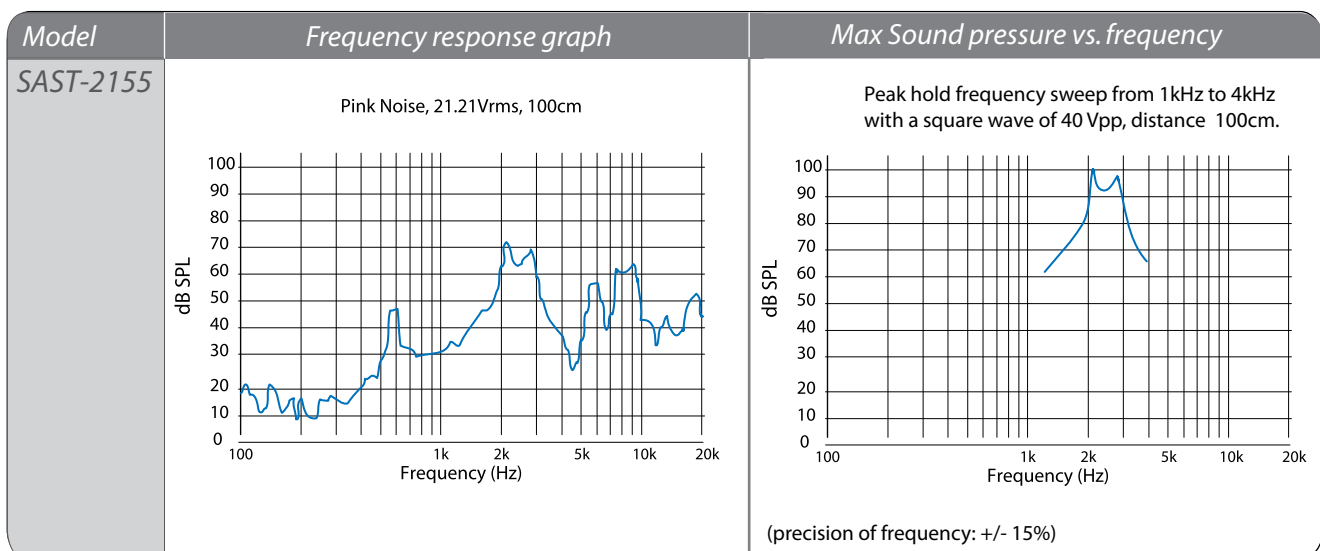

DIMENSIONS SAS SERIES (all dimensions are in mm)

Dimensions SAS-2155-S & SAST-2155 without mounting bracket

Fast-on version

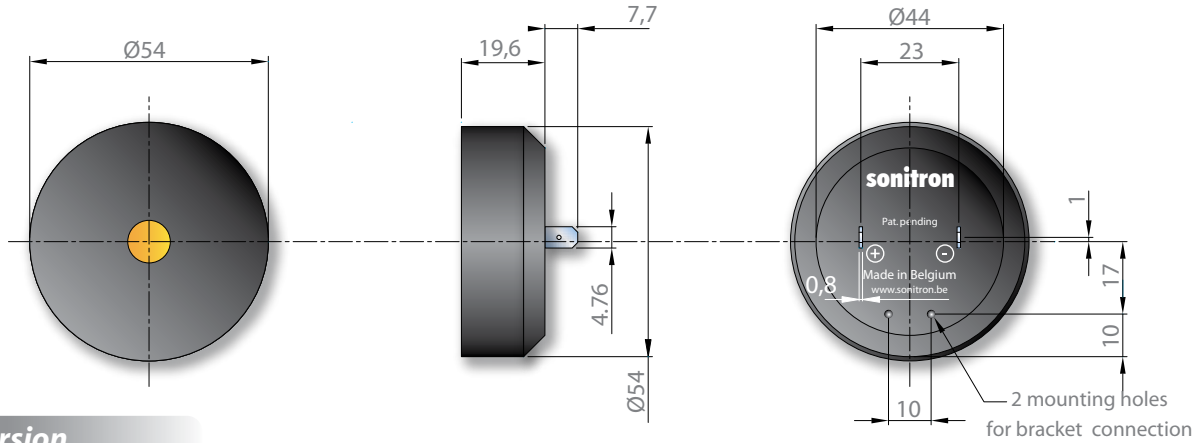

Pin version

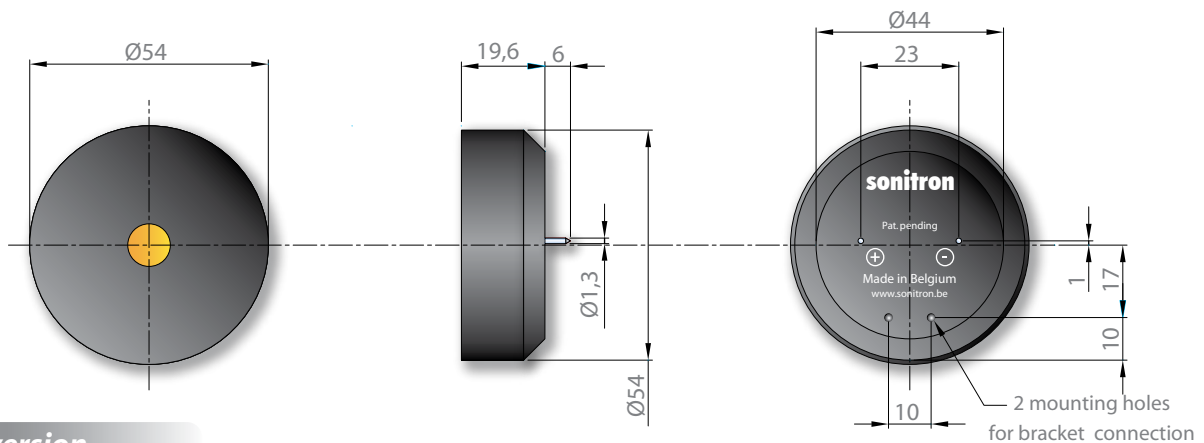

Wire version

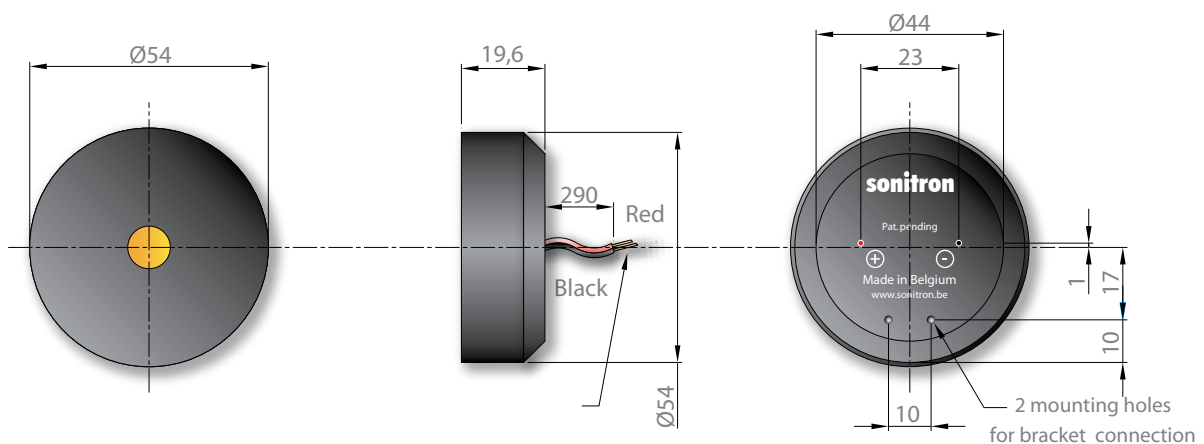

PRODUCT OPTIONS

1. Dimensions with mounting bracket (MB1)

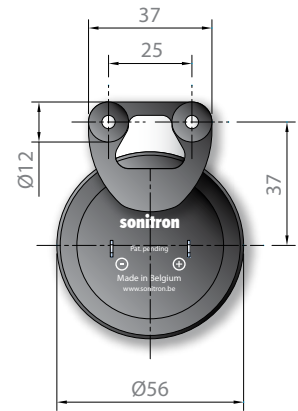
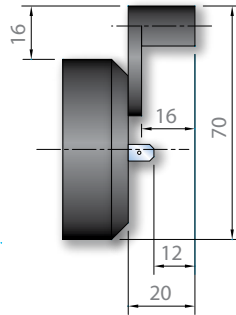
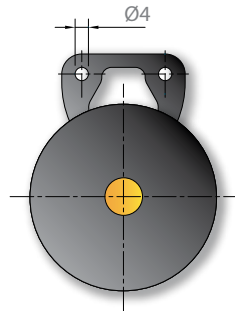
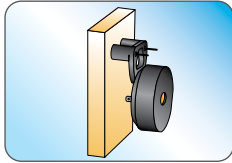

2. Dimensions with mounting bracket (MB2)

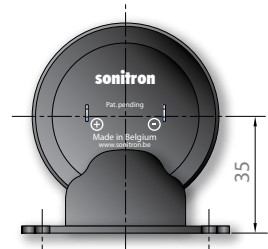
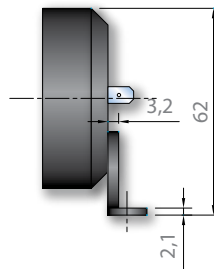
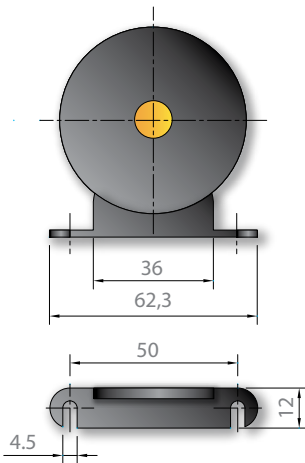
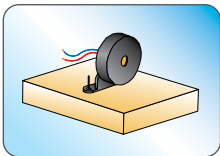

grooves version

3. Dimensions with mounting bracket (MB3)

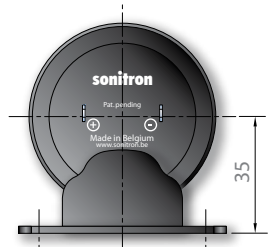
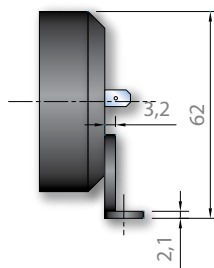
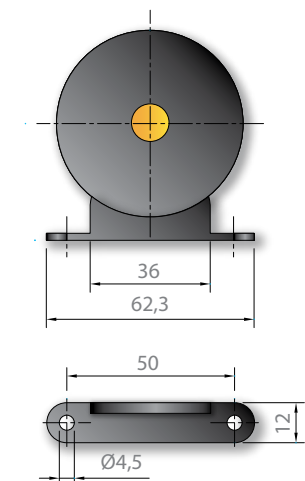
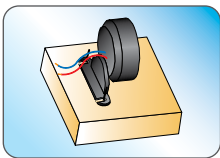

holes version

Tolerance: +/- 0.2mm mm

PRODUCT CODIFICATION

SAS ↓ Sonitron Alarm Series	T - 2155 ↓ Transducer (without electronics)	S ↓ S: sweep	W P F ↓ W: wire AWG 24 (12cm) P: round pin F: fast-on terminal 4.76mm	MB ↓ Mounting Bracket	1 2 3 ↓ 1: wall connection 2: flat connection (with grooves) 3: flat connection (with holes)	S ↓ Separate mounting bracket
-----------------------------------	---	--------------------	---	-----------------------------	--	-------------------------------------

LIST OF AVAILABLE PRODUCT TYPES

Without bracket

SAS-2155-S-F	SAS-2155-S-P	SAS-2155-S-W
SAST-2155-F	SAST-2155-P	SAST-2155-W

With bracket

SAS-2155-S-F-MB1 SAS-2155-S-F-MB2 SAS-2155-S-F-MB3	SAS-2155-S-P-MB1 SAS-2155-S-P-MB2 SAS-2155-S-P-MB3	SAS-2155-S-W-MB1 SAS-2155-S-W-MB2 SAS-2155-S-W-MB3
SAS-2155-S-F-MB1S SAS-2155-S-F-MB2S SAS-2155-S-F-MB3S	SAS-2155-S-P-MB1S SAS-2155-S-P-MB2S SAS-2155-S-P-MB3S	SAS-2155-S-W-MB1S SAS-2155-S-W-MB2S SAS-2155-S-W-MB3S
SAST-2155-F-MB1 SAST-2155-F-MB2 SAST-2155-F-MB3	SAST-2155-P-MB1 SAST-2155-P-MB2 SAST-2155-P-MB3	SAST-2155-W-MB1 SAST-2155-W-MB2 SAST-2155-W-MB3
SAST-2155-F-MB1S SAST-2155-F-MB2S SAST-2155-F-MB3S	SAST-2155-P-MB1S SAST-2155-P-MB2S SAST-2155-P-MB3S	SAST-2155-W-MB1S SAST-2155-W-MB2S SAST-2155-W-MB3S



SMAC SERIES

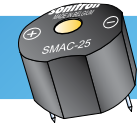

Piezo acoustic components are more and more used in small portable equipment and as a critical alerting device. Reliability must be very high in the most difficult environmental circumstances, such as extreme and varying temperatures, vibrations, shocks, dust conditions, humid environment etc. The SMAC-25 buzzer, manufactured with over 30 years of experience in the field of piezo acoustic technology, is a very stable buzzer with a lifetime of more than 1000 hours in continuous use. In these small dimensions, the SMAC-25 is actually the best available piezo alarm for life supporting systems.



ADVANTAGES & APPLICATIONS

ADVANTAGES :

- Electronics included
- Rounded octagonal shape – new design !
- PCB mounting (pin version)
- Shock, dust & waterproof (IP67)
- Produces a high reliable, clear and penetrating sound
- Light but solid construction
- Low power consumption
- Easily mountable
- Low cost compared to quality

APPLICATIONS :

- Alarms
- Monitoring & test equipment
- Trucks & automobiles
- Boats & airplanes
- Signalization & process control equipment
- Fire detectors
- Battery powered handheld devices
- Gas detectors
- Life support systems
- Control instrumentation & systems
- Intensive care systems

SPECIFICATIONS



Model	Function	Sound pressure level (dB(A)(±2dB(A))	Frequency (Hz)(±15%)	Operating voltage (Vdc)	Operating DCcurrent(mA)
SMAC-25	continuous	93.5	3350	5-16 Vdc	9.7
SMACI-25	intermittent*	93.5	3350	5-16 Vdc	9.7
SMAC-25L	continuous	100	3350	5-35 Vdc	17
SMACT-25	transducer	see graph	see graph	-	-

* Pulse rate 1 Hz (+/-15%)

Capacitance (+/-30%) nF	Operating voltage (VAC pp)
20nF	0 to 30

Operating temperature:	-40°C to +85°C
Storage temperature:	-40°C to +85°C
Expected life time:	>1000 hours @ 21°C @ 12 Vdc (free air) mounted on print
Color:	grey, black
Terminals:	pins (tinned brass)
Case material:	PBT (UL rating: 94 HB)
Weight:	7.8 - 8.5 g

* All measurements are made in free air @ 21°C @ 30 cm @ 12 Vdc.
The test buzzer is soldered on a PCB board with dimensions of 24 cm x 11 cm.

ELECTRICAL PARAMETERS

Sound pressure level vs. operating voltage

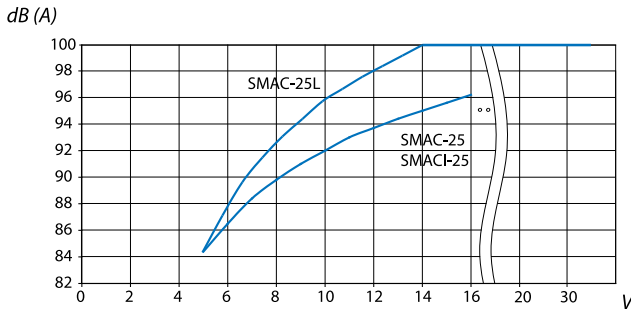

Current consumption vs. operating voltage

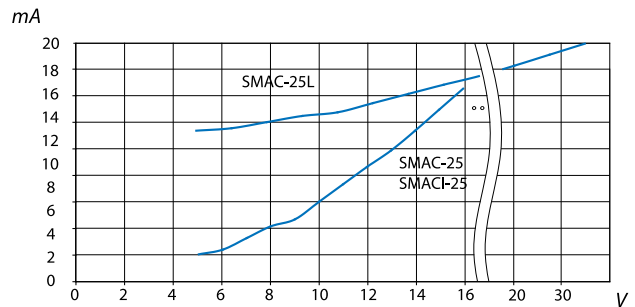

TRANSDUCER: SMAC-25

Maximum sound pressure vs. frequency

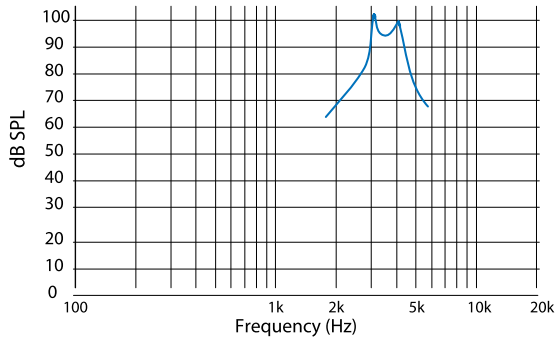

Peak hold frequency sweep from 1kHz to 4kHz with a square wave signal of 30 Vpp, distance 30cm. (precision of frequency: +/-10%)

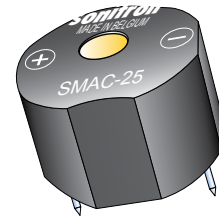

DIMENSIONS (All dimensions are in mm)

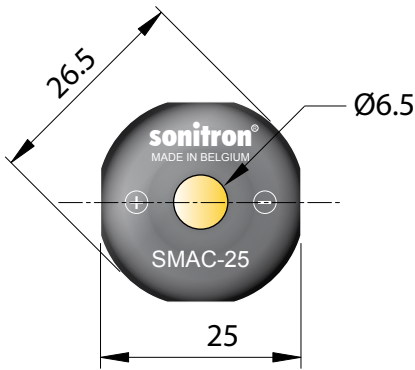

Pin material: tinned brass
Case material: grey or black PBT

Tolerance: +/-0.2 mm

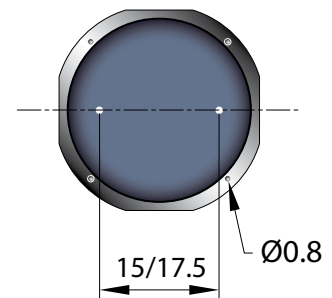
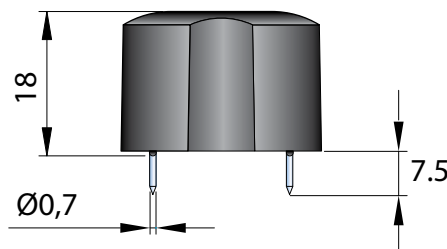

Foam Patch included for Mechanical & acoustic stabilization (only SMD version)

The SMD version has been tested in production with a low temperature reflow soldering process. More information and machine profile, see page 141.

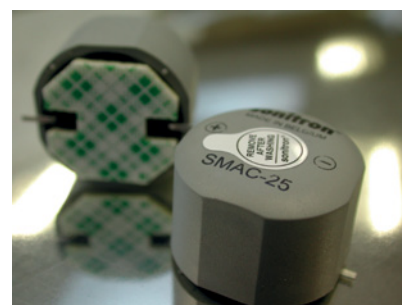
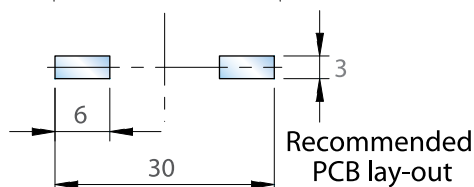

PRODUCT CODIFICATION

SMAC	I -	25	L	P-S-W connections
Sonitron Multi Application Cup	Intermittent	Square diameter (mm)	Loud	P15 : pin distance 15 mm P17.5 : pin distance 17.5 mm S : SMD terminals W100 : 2 wires length 10cm
	T - Transducer			

LIST OF AVAILABLE PRODUCT TYPES

SMAC-25-P15	SMACI-25-P15	SMAC-25L-P15	SMACT-25-P15
SMAC-25-P17.5	SMACI-25-P17.5	SMAC-25L-P17.5	SMACT-25-P17.5
SMAC-25-S	SMACI-25-S	SMAC-25L-S	SMACT-25-S
SMAC-25-W100	SMACI-25-W100	SMAC-25L-W100	SMACT-25-W100

PRODUCT OPTIONS

Option Code	example	Description
MC	SMAC-25-P15- MC	Acryl coating: The protective coating gives a complementary assurance against smog. All Smac series buzzers are perfectly waterproof (IP67) without the mentioned coating.
Wash Tab	SMAC-25-P17.5 +Wash Tab	Recommended for automatic washing production process. The Wash Tab is upon the sound-emitting hole, avoiding liquid penetration into the cavity. TO BE REMOVED AFTER the washing process for good sound output!!!
FP21	SMACI-25-P15- FP	Acoustic stabilization Foam Patch, easy to stick. For: SMAC(I)-25-P15 SMAC(I)-25-P17.5

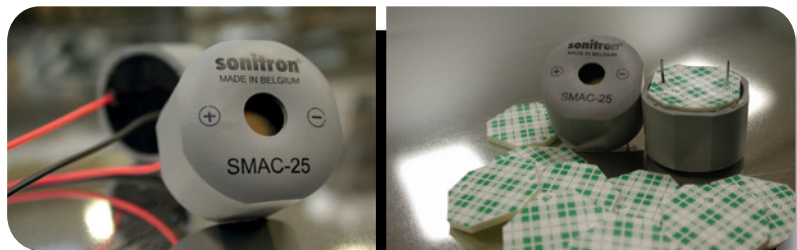

PACKAGING

The SMAC-25 buzzers are packed on a polystyrene board (245 L x 245 W) and sold in boxes with dimensions of 250 L x 250 W x 125 H.

SMAC-25	
per board	81
per box	(5x81) 405

SXL SERIES

Extreme loud

STANDARD SERIES

Sonitron's extremely loud series presented in a standard series housing are used in conditions that requires immediate attention getting and action to prevent dramatic situations. In this series Sonitron used more than 30 years experience know-how and elaborated working principles.



ADVANTAGES & APPLICATIONS

ADVANTAGES :

- Extremely high sound pressure level with a very clear and penetrating sound output
- Solid state shock proof buzzer
- Dust and waterproof, rated to IP67
- PCB and panel mounting; pin or fast-on terminals
- Very high reliability
- Low power consumption
- Wide operating supply range
- Wide temperature range
- Electronics potted in epoxy
- Small in dimensions

APPLICATIONS :

- Alarms
- Agricultural equipment
- Monitoring and test equipment
- Medical equipment
- Military equipment
- Trucks & automobiles
- Boats & airplanes
- Signalling & process control equipment
- Fire detectors
- Vending-machine
- Cockpit alarm

SPECIFICATIONS



Operating temperature	-40°C to +85°C
Storage temperature	-40°C to +85°C
Life time (at 21°C)	@12Vdc continuous use min. 9 hours (expected life time curve in addendum)
Case material	ABS (UL rating: 94 HB)
Standard colour of case	Black
Terminal material	Tinned brass for both pin terminals and fast-on terminals
Supplemental	Reverse voltage protected. Weight: 22g

Model	Function	Operating voltage		Frequency (Hz) (±30%)	Operating current (mA)		Sound pressure level* (dB(A))	Weight (g)
		min Vdc	max Vdc		@V min.	@V max.		
SXLC 515 C	continuous	5	15	3000	25	130	102	22
SXLI 515 C1	multifunction	5	15	3000	13	70	96	22
SXLW 515 C	warbler	5	15	3000	30	120	104	22
SXLP 515 C	sweep	5	15	3000	55	110	102	22

*All measurements are made @ 1 meter @ 12 Vdc in free air @21°C.

ELECTRICAL PARAMETERS

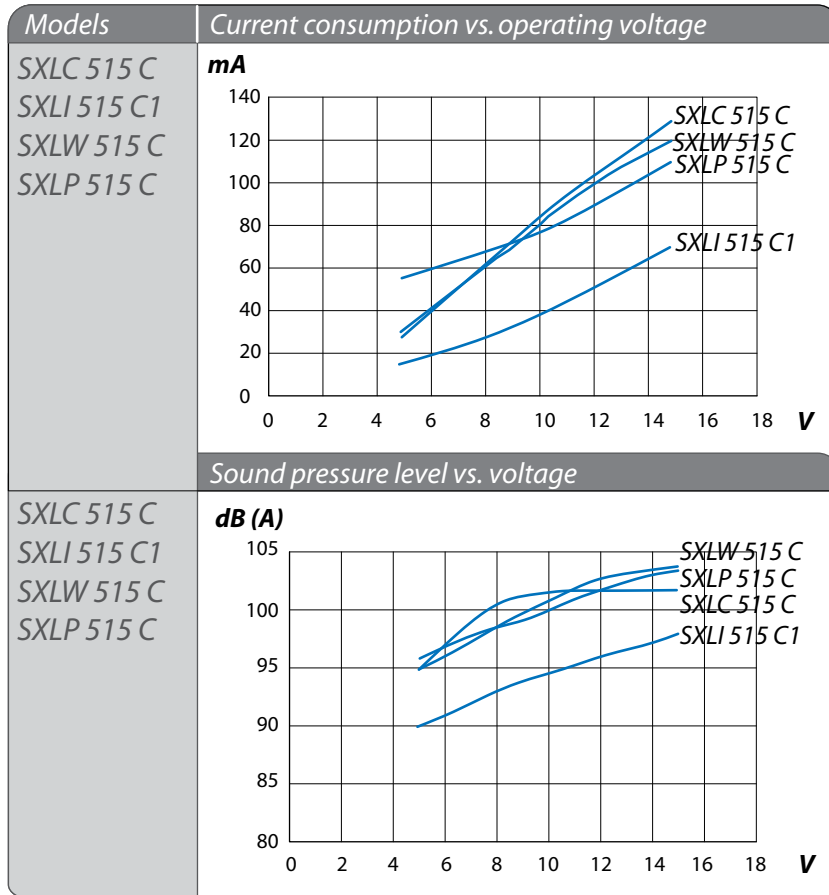

All measurements are made @ 12Vdc @ 1 meter in free air @ 21°C.

DIMENSIONS (All dimensions are in mm)

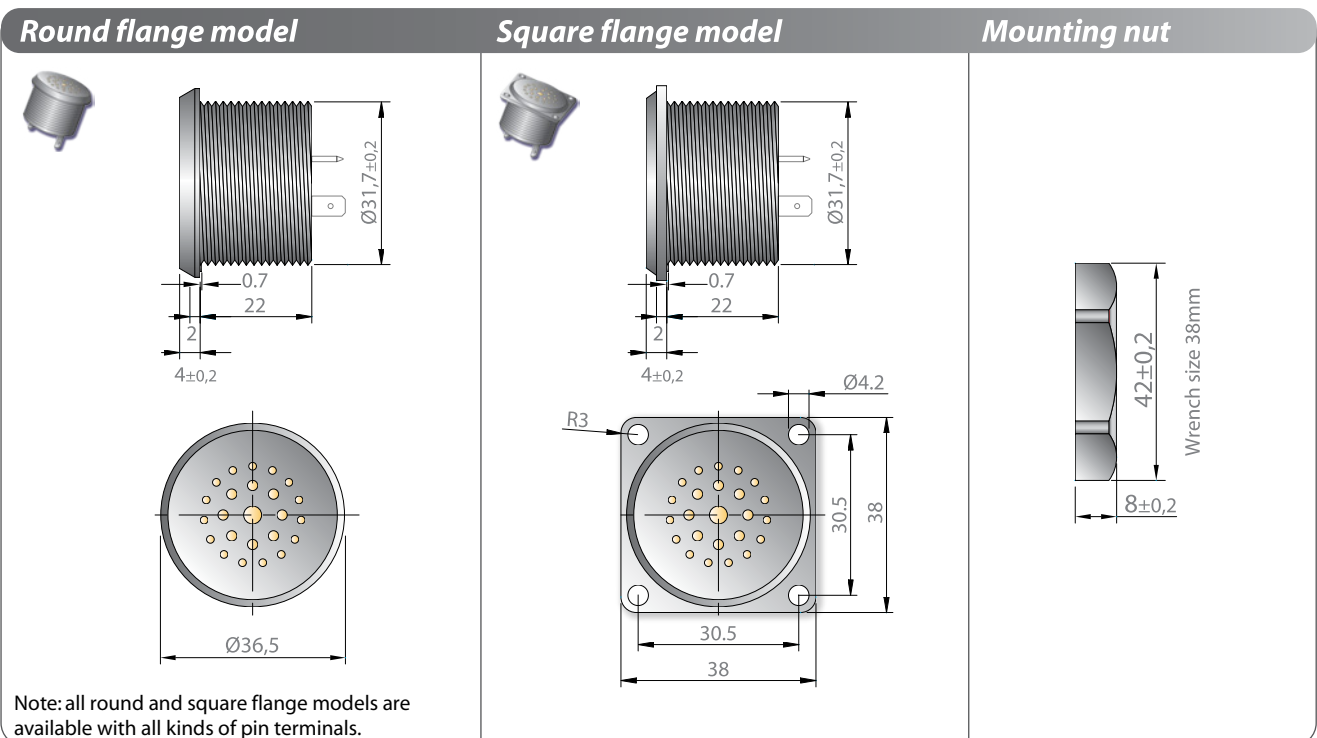

Models (2 pins) SXLC, SXLW, SXLP (3 pins) SXLI

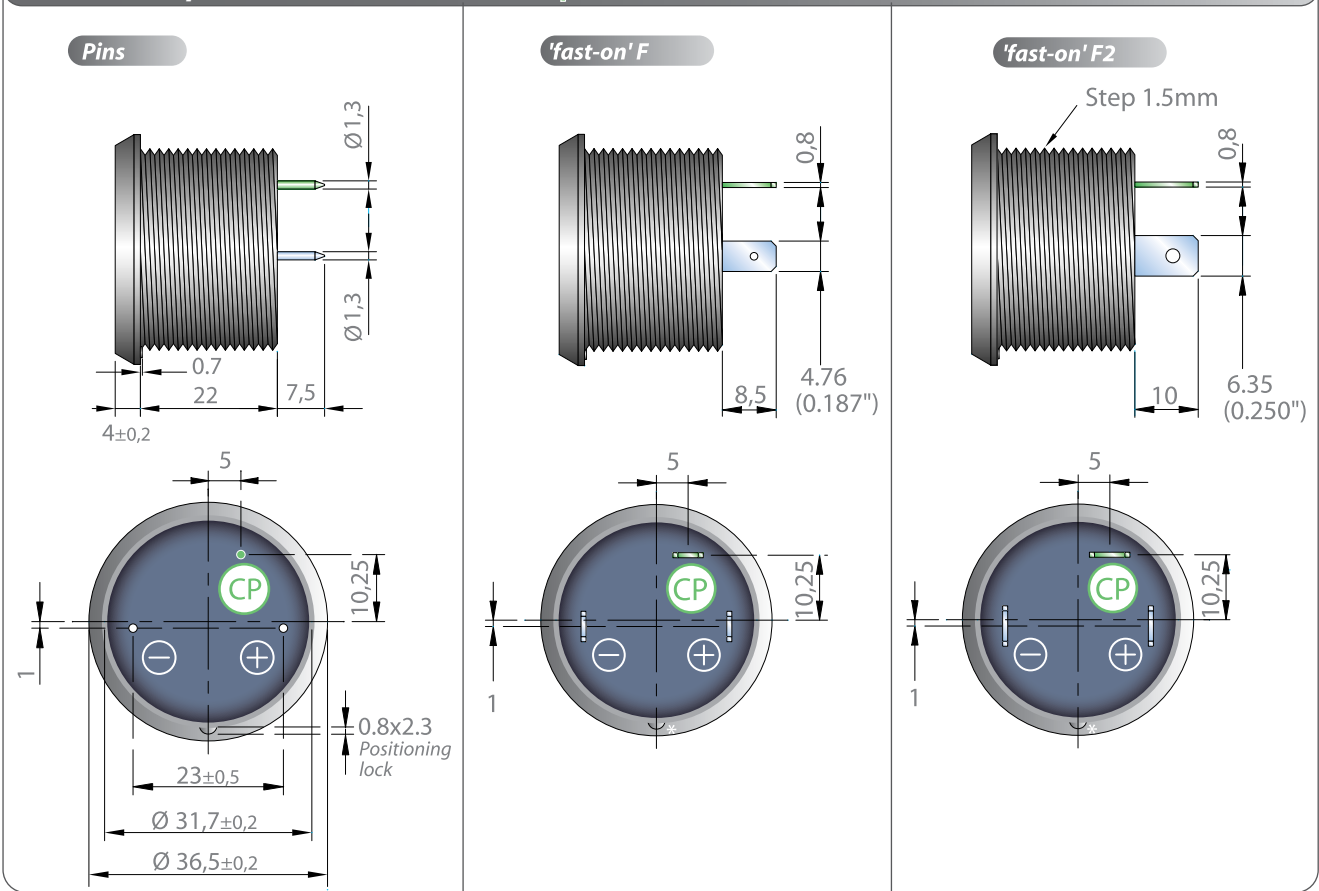

Note: control pin (CP) only with multifunction buzzers.

*0.8x2.3 Positioning lock

PRODUCT CODIFICATION

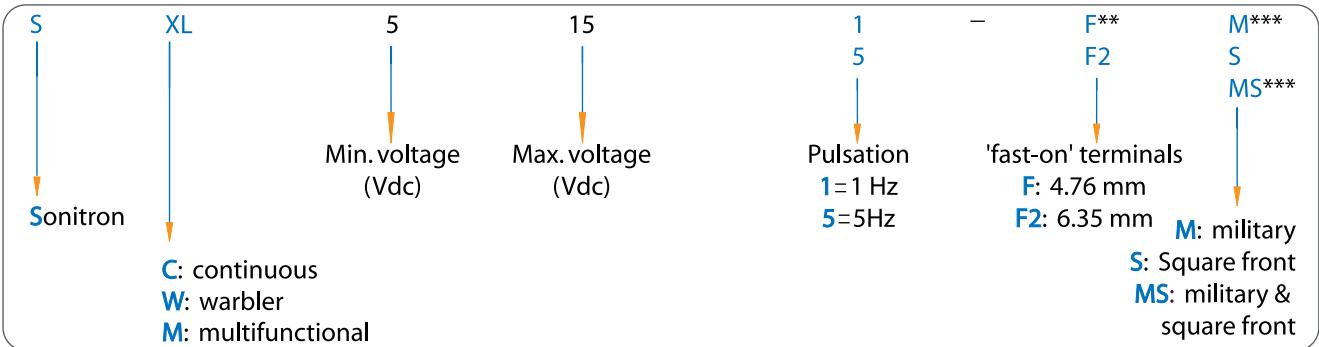

F** If no terminal specification, the model is standard delivered with round pins, diameter 1.5 mm. Fast-on terminals are available in 2 dimensions: F= 4,76 mm (0,187 inch) or F2 = 6,35 mm (0,250 inch).

M*** Military norm MIL STD 202

LIST OF AVAILABLE PRODUCT TYPES

SXLC 515 C SXLC 515 C F SXLC 515 C F2 SXLC 515 C F M SXLC 515 C F2 M SXLC 515 C S SXLC 515 C F S SXLC 515 C F2 S SXLC 515 C F MS SXLC 515 C F2 MS	SXLI 515 C1 SXLI 515 C1 F SXLI 515 C1 F2 SXLI 515 C1 F M SXLI 515 C1 F2 M SXLI 515 C1 S SXLI 515 C1 F S SXLI 515 C1 F2 S SXLI 515 C1 F MS SXLI 515 C1 F2 MS	SXLW 515 C SXLW 515 C F SXLW 515 C F2 SXLW 515 C F M SXLW 515 C F2 M SXLW 515 C S SXLW 515 C F S SXLW 515 C F2 S SXLW 515 C F MS SXLW 515 C F2 MS	SXLP 515 C SXLP 515 C F SXLP 515 C F2 SXLP 515 C F M SXLP 515 C F2 M SXLP 515 C S SXLP 515 C F S SXLP 515 C F2 S SXLP 515 C F MS SXLP 515 C F2 MS
--	--	--	--

Packaging and models on request, see general information about "Standard series"(page 34).

SDS SERIES

INTRODUCTION

“Piezo Sound Technology, an endless world of possibilities”

Sonitron **D**igital **S**quare refers to a technology that is driving a piezo cup membrane mounted in a cavity, with a square wave. The combination of drive frequency and the high quality response of the cup membrane adjusted to the best acoustic function of the cavity in which the cup membrane is mounted, offers an extremely high sound output.

The drive signal to the piezo is a square wave with a sufficient (Vpp) peak to peak voltage. Square wave pulses contain very rich harmonic content of energy.

The tuned square wave signal with rich harmonics is driving the piezo cup membrane, the acoustic function of the cavity combined with the piezo cup and the drive frequency is tuned until max. sound output for several harmonic frequencies. The character and pitch of the sound output wave can be adjusted to the desired acoustic signal.

Endless possibilities are revealed...

Prototype model



A combination of 2 cup acoustic cavities, are used for making the car horn sound.

According to directive 70/388/ECC of the European Commission, an audible warning device for motor vehicles must produce a total SPL of min 105 dB(A) and max 118 dB(A) at a distance of 2m.

The spectrum of the sound emitted by the device, measured at a distance of 2m, must show a sound pressure higher than that of any frequency component above 3550Hz in the 1800 to 3550Hz frequency band, and in no case less than 105 dB(A).

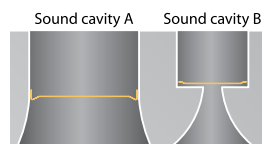

Cup A delivers the body of the sound. It is a mixed combination of low frequencies with a loud sound pressure level, tuned on the human ear to warn for a situation with a non aggressive touch.

Cup B delivers the high sound component of min 105 dB(A) with a frequency between 1800Hz and 3550Hz.

Basic terms: see "Considerations about sound" in addendum

Piezo acoustic system Cup A

To design a useful housing for a car horn, an acoustic system that amplifies a few low frequencies to a high amplitude will give a typical warm warning sound.

The red line in figure one shows the pink noise response* of a high quality piezo cup system that results in a first peak around 400Hz. A square wave is analysed (figure 2) and tuned on the amplification peaks of the piezo vibrating system.

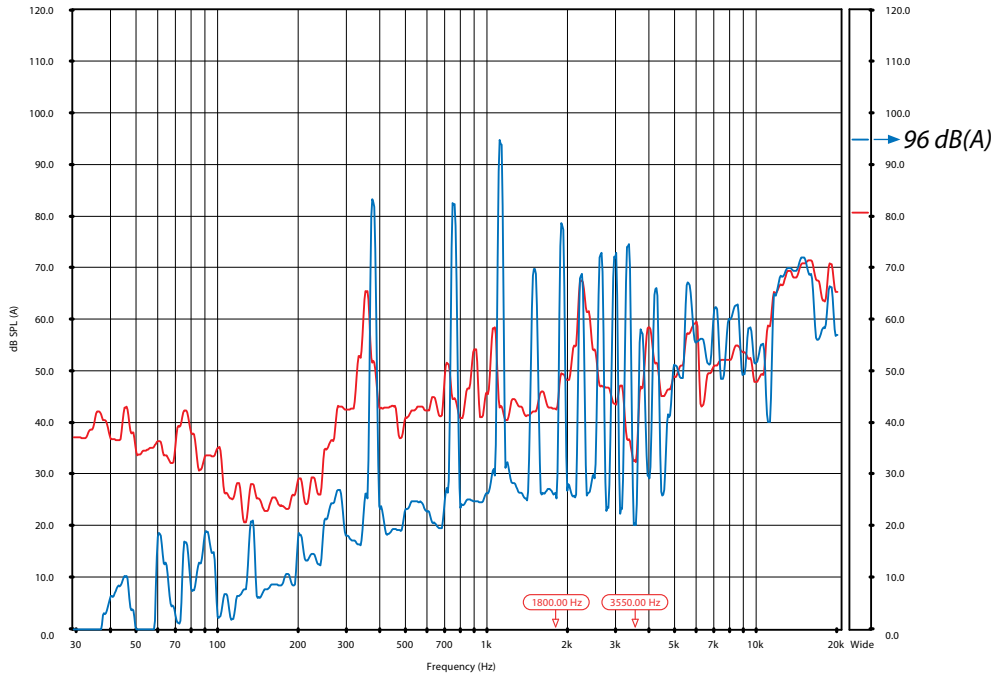

Figure 1: pink noise graph (red) and total SPL (blue)

The total sound pressure level is shown in the right table of figure one (blue line) and reaches 96dB(A) at 2m. The character of the sound is mainly formed by three sine waves at 374Hz (f), 748Hz (2f) and 1122Hz (3f).

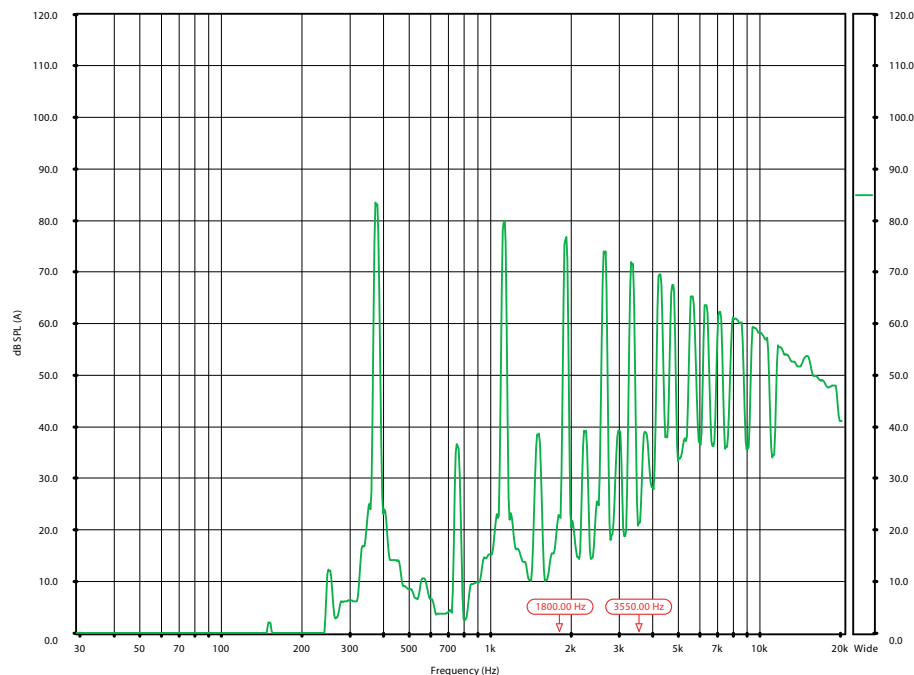

Figure 2: Fourier analyse square wave 374 Hz

*definitions see sound considerations in addendum

Piezo acoustic system cup B

To reach the description of the European Commission the highest peak has to be a frequency between 1800 Hz and 3550 Hz with a minimum level of 105 dB(A) at 2m.

For this challenge we use a high quality cup vibrating system with an amplification peak in the region 2000Hz to 3000Hz. The red line in figure 3 defines the pink noise graph.

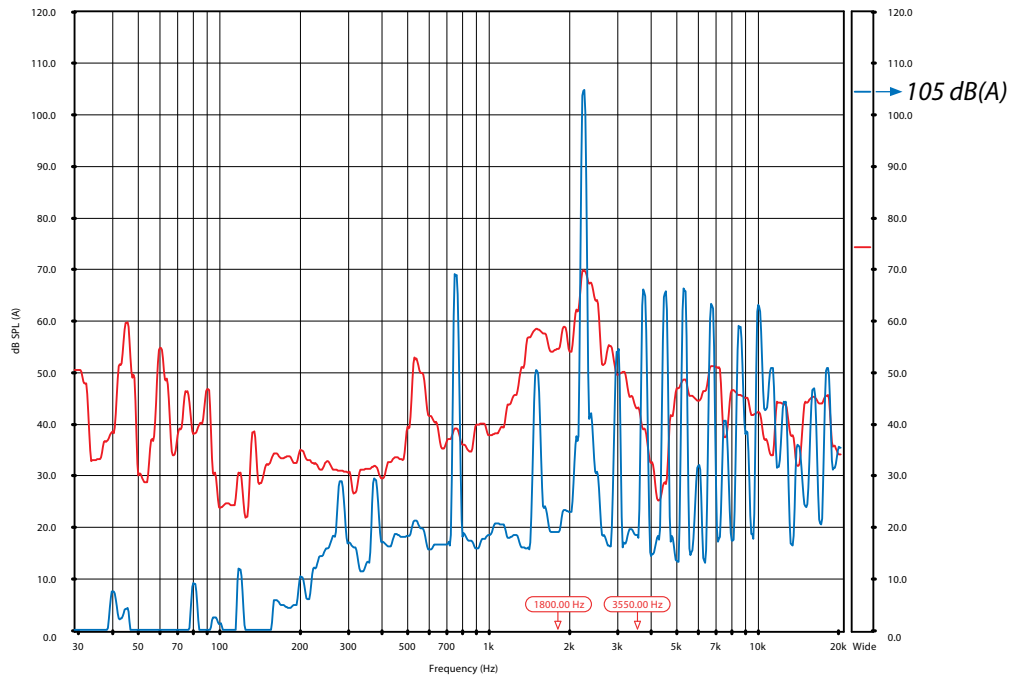

Figure 3: pink noise graph (red) and total SPL (blue)

The blue line in figure 3 shows the total sound pressure with a total SPL of max. 105dB(A) at 2m with the highest peak at 2260Hz (3f).

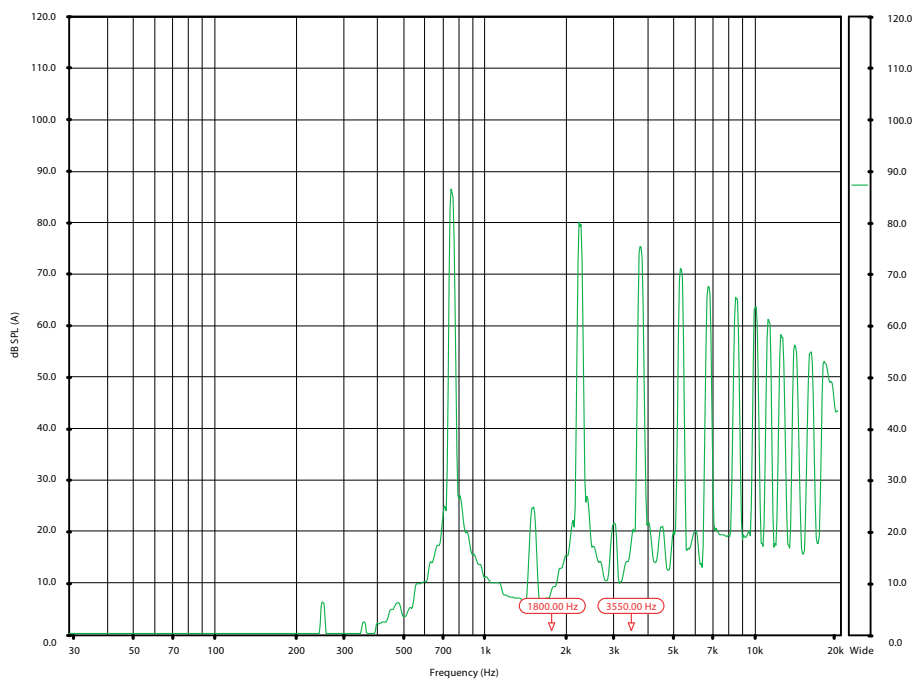

Figure 4 : Fourier analyse square wave 754 Hz

A square wave signal of 754 Hz (figure 4) is analyzed with the third harmonic tuned on the peak response of the acoustic chamber.

The digital pulse drive signal rich in harmonics is adjusted in frequency, until the drive signal harmonic's are synchronized with the acoustic cavity max. sound peaks.

The combination of both systems enables the creation of an endless number of sound signals or different alarm applications such as vehicle industry, sirens, security warning in acces and door controls, red light stop warning, ultrasound detection process, optical sensor detection, etc...

A typical car horn adjusted with two piezo systems as described above is consuming only 20% of a traditional magnetic car horn, adjusted to a specific acoustic sound signal with a specific complex low frequency content.

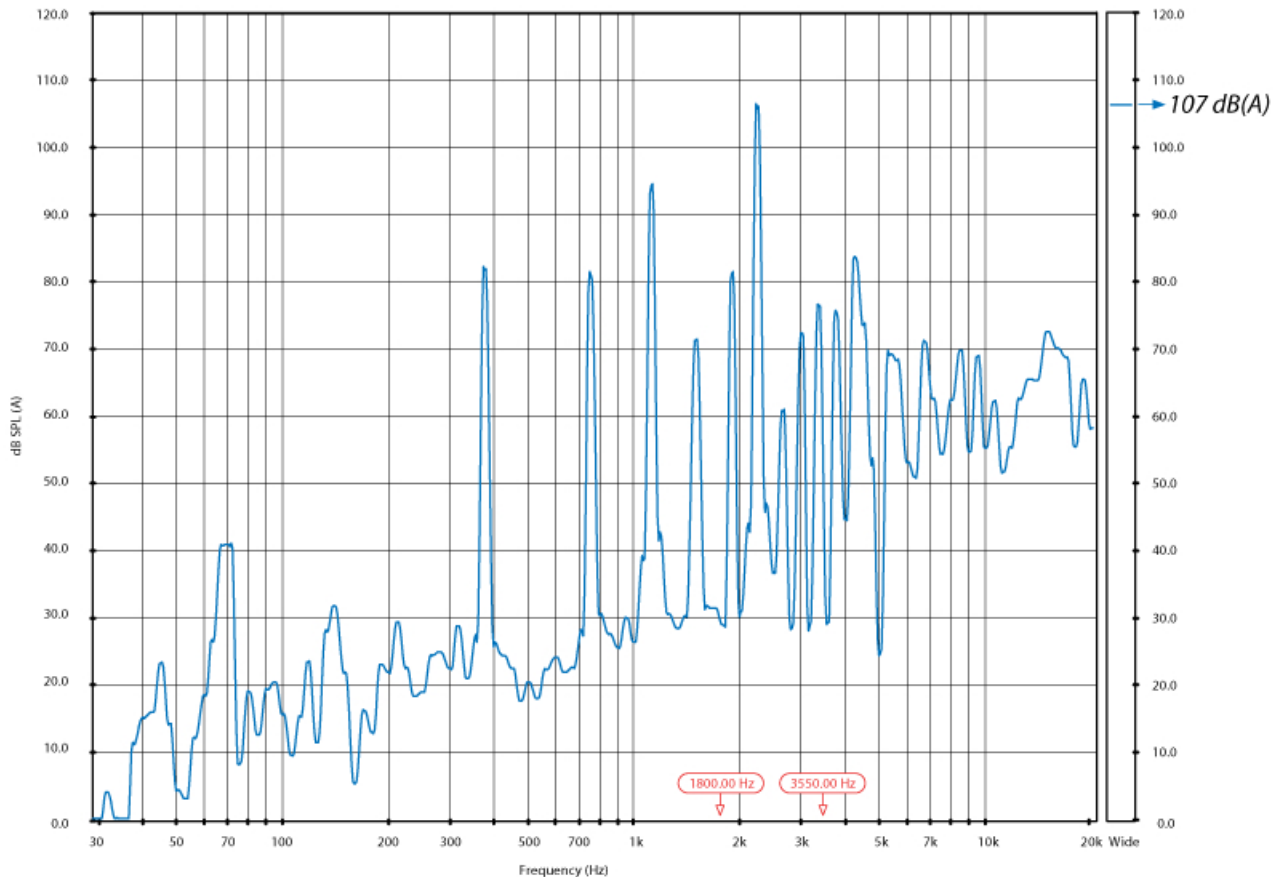
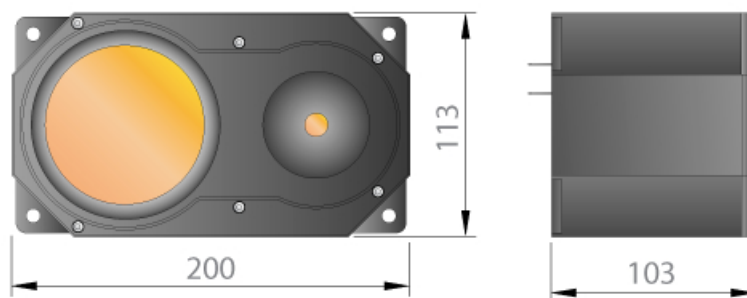

Fig 5: Frequency response and total SPL of the car horn prototype model at 2m.

DIMENSIONS (car horn prototype model)



Specific acoustic systems and electric drive circuits can be designed and developed by SONITRON on demand of the customer.

For more information and models on request, please email sales@keiconn.com.

PIEZOCERAMIC SPEAKERS PIEZO AUDIO AMPLIFIERS

SCS Series

SPS Series

Blue line SPS Series

PAA Series

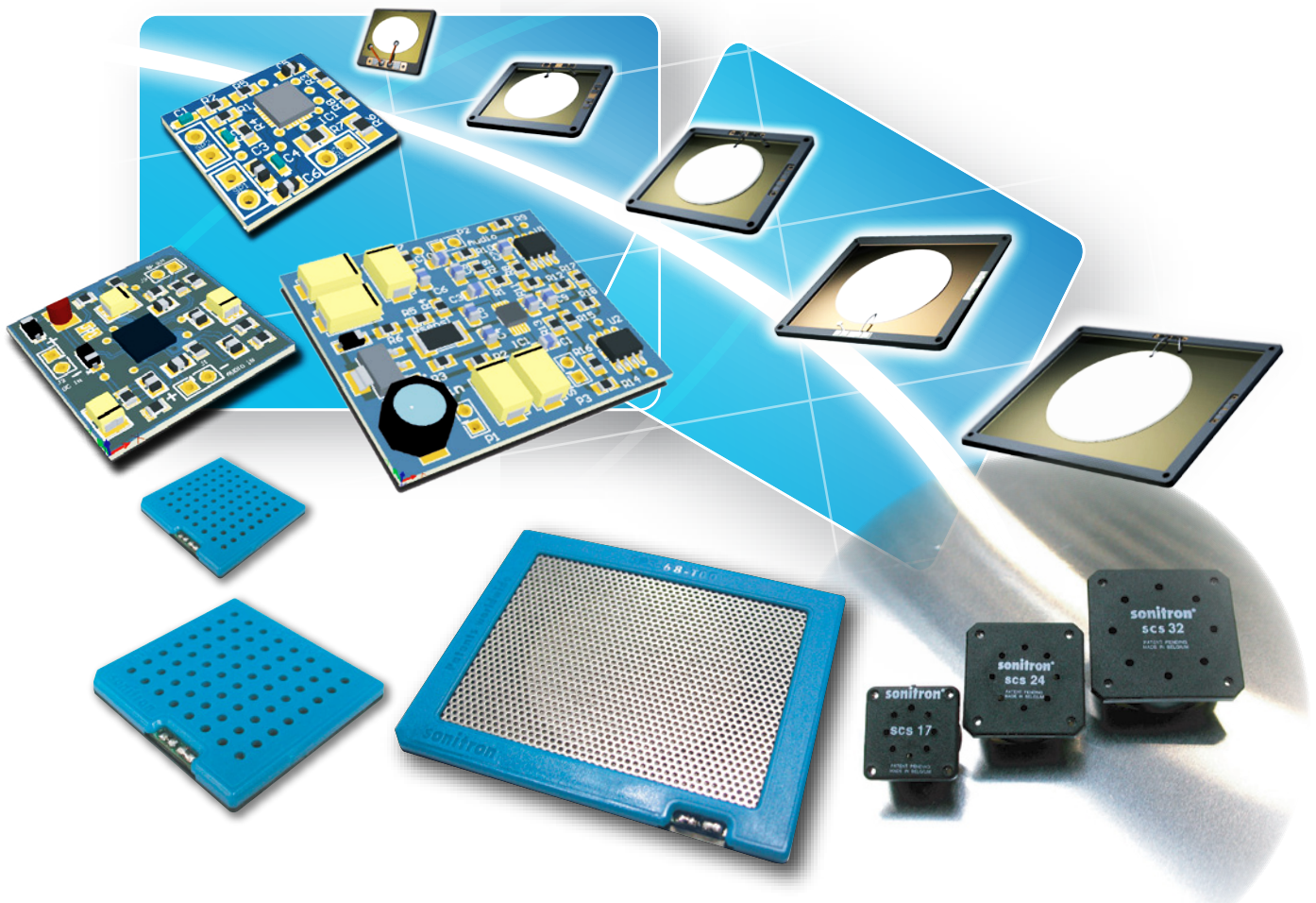

SPS-Series: these are special speakers developed on special requests for OEM applications, modifications can be realized on dimensions, mounting, sound frequency, SPL, color, soldering method etc...

"Advanced Technology with smart materials such as piezoceramics offer many new applications in audible components and devices. This new technology is a continuous development work that will bring you to the forefront in this world."

KEY QUESTIONS FOR SPEAKER DETERMINATION

1. Mounting method:
glued, screws, pins, ultrasonic ?

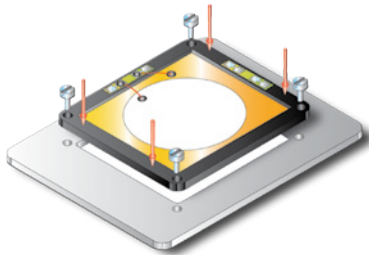

2. Connection method:
wires, pressure spring contacts, solder pads ?

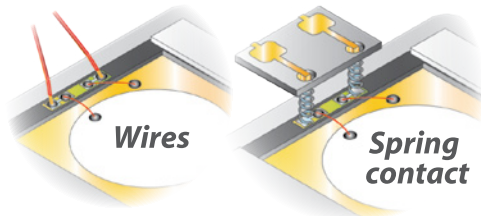

3. Maximum dimensions (in mm):
length, width, thickness ?

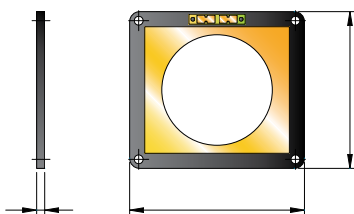

4. Supply voltage:
battery or mains supply ?



5. SPL – dB @ 1 meter ?

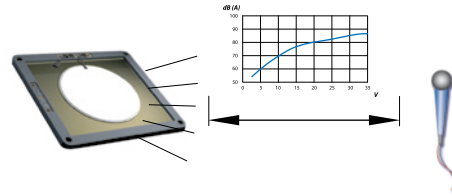

6. Operating frequency range ?

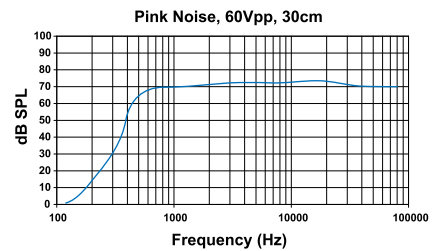

7. Type of audio signal ? Speech, Music,...



8. Temperature range in °C ?

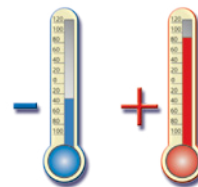

GENERAL OVERVIEW SCS-SPS-BLUE LINE-PAA SERIES

Model	Frequency range	Max. SPL	Operating voltage
-------	-----------------	----------	-------------------

SCS series



SCS-17	1500-8000	2200 Hz - 92 dB 5000 Hz - 91 dB	5 to 30 Vpp
SCS-24	1000-8000	800 Hz - 68 dB 1600 Hz - 95 dB 4000 Hz - 87 dB	5 to 30 Vpp
SCS-32	500-8000	650 Hz - 85 dB 2700 Hz - 100 dB 3700 Hz - 88 dB 7500 Hz - 80 dB	5 to 30 Vpp

Measurement MaxSPL in free air @ 30 cm, 30Vpp sine wave.

SPS series

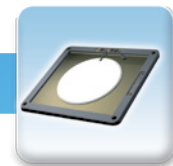

SPS-2220-03	700-20 kHz	85 dB*	1 to 24 Vpp
SPS-3530-03	700-20 kHz	81 dB	5 to 60 Vpp
SPS-4640-03	400-20 kHz	83 dB	5 to 60 Vpp
SPS-6555-03	300-20 kHz	83 dB	5 to 60 Vpp
SPS-8770-03	200-20 kHz	84 dB	5 to 60 Vpp

*Measurement Max. SPL: average @ 4 points, @ 1m, 60Vpp. (SPS-2220-03 @ 10 cm, 24Vpp)

Blue Line SPS series

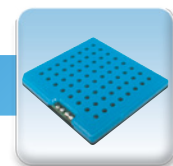

SPS-29-T00	1-20 kHz	86 dB*	5 to 60 Vpp
SPS-41-T00	450Hz-20 kHz	90 dB	5 to 60 Vpp
SPS-53-T00	300Hz-20 kHz	93 dB	5 to 60 Vpp
SPS-68-T00	250Hz-20 kHz	93 dB	5 to 60 Vpp

*Measurement Max. SPL: average @ 4 points, @ 1m, 60Vpp.

PAA series

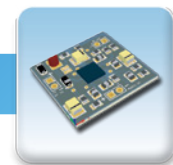

	Max. output voltage
PAA-LT3469-01	30 Vpp
PAA-MAX9788-01	20 Vpp
PAA-LM4960-02	24 Vpp
PAA-StepUpBTL-01	60 Vpp

SCS SERIES (SONITRON Ceramic Speakers)



INTRODUCTION

Introduced as the first models of Sonitron's piezoceramic speakers, the SCS-series are still being used for numerous applications.

Good sound quality and limited distortion guarantee a clear reproduction of multiple tones, speech and music. The piezo speaker has 60% more net sound output per membrane surface than the electro-dynamic speaker in function of the average current drain and average sound pressure level. These loudspeakers are extremely reliable, have a robust design and can be used in difficult environmental conditions and applications because of resistance of the front to water, humidity, vibrations and dust.

The SCS-speaker can be mounted by soldering the SMD pads onto the PCB.

For a pin-version, the pins can be soldered onto the PCB. Extra stability against vibration is achieved by screwing the housing onto the application.

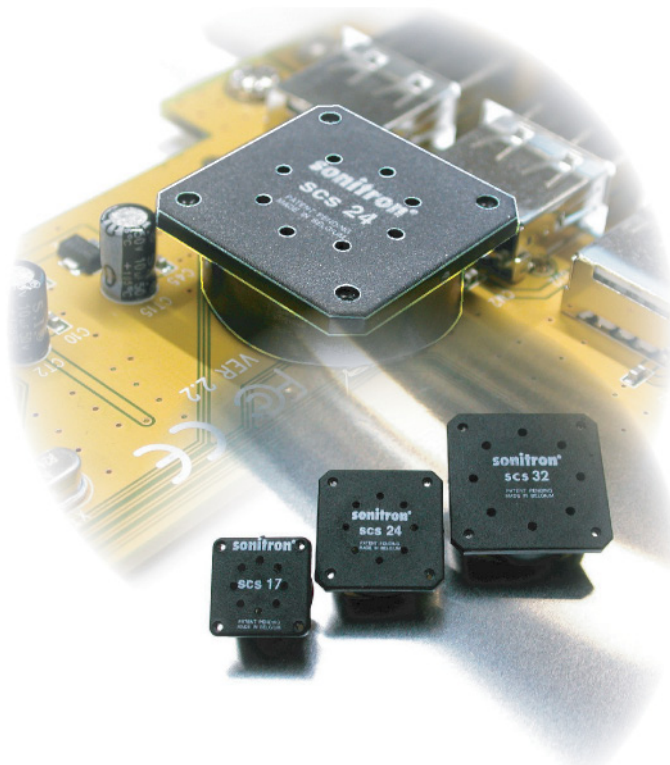

GENERAL OVERVIEW SCS-SERIES

Model	Frequency range	Peak frequency SPL	Operating voltage
SCS-17	1500 - 8000 Hz	2200 Hz - 92 dB 5000 Hz - 91 dB	5 to 30 Vpp
SCS-24	1000 - 8000 Hz	800 Hz - 68 dB 1600 Hz - 95 dB 4000 Hz - 87 dB	5 to 30 Vpp
SCS-32	500 - 8000 Hz	650 Hz - 85 dB 2700 Hz - 100 dB 3700 Hz - 88 dB 7500 Hz - 80 dB	5 to 30 Vpp



ADVANTAGES & APPLICATIONS

ADVANTAGES:

- very flat and solid construction
- dust, water- and shockproof front panel
- resistant to temperature variations
- broad frequency range in small size
- combined use as speaker/microphone
- no electromagnetic field (EMC)
- little energy required at low frequencies
- less current consumption needed in the leads to the speaker
- 60% higher acoustic output in smaller speakers compared to electrodynamic speakers
- low weight
- high impedance
- can be driven directly by IC

APPLICATIONS:

- home equipment & domotics
- communication equipment
- home monitoring equipment
- talking buzzer & door bell
- computer equipment
- vending machines
- electronic wheelchair
- medical equipment
- multimedia equipment
- industrial equipment
- flight instrumentation
- portable voice recorders
- paging systems
- instrumentation

SPECIFICATIONS

Operating temperature:	-40°C to +85°C
Storage temperature:	-40°C to +85°C
Case material:	PBT (UL rating: 94 HB) for pin-versions), PPS (UL rating: 94 V0/5V) for SMD-versions)
Standard colour of case:	Black

Model	Frequency range	Peak frequency SPL	Capacitance ±20%	Operating voltage	Impedance @ 1KHz ±20%	Weight
SCS-17	1500 - 8000 Hz	2200 Hz - 92 dB 5000 Hz - 91 dB	20 nF	5 to 30 Vpp	7957 ohm	1.7 g
SCS-24	1000 - 8000 Hz	800 Hz - 68 dB 1600 Hz - 95 dB 4000 Hz - 87 dB	37 nF	5 to 30 Vpp	4300 ohm	4 g
SCS-32	500 - 8000 Hz	650 Hz - 85 dB 2700 Hz - 100 dB 3700 Hz - 88 dB 7500 Hz - 80 dB	66 nF	5 to 30 Vpp	2400 ohm	5.9 g

All measurements are made in free air @30 cm using a 30 Vpp sine wave.
The speakers were mounted in a box with dimensions 40x15x5 cm.

IMPEDANCE

Theoretical the main impedance of the piezo speakers is a capacitive reactance and follows an asymptotic function.

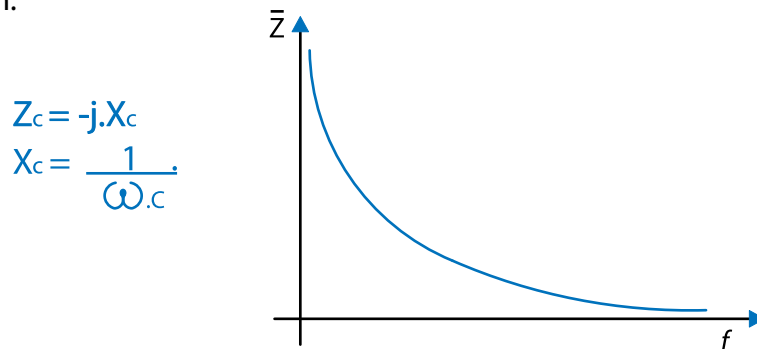

The typical practical impedance values (± 20%) for frequencies of 100 Hz up to 20 kHz of our speakers are as follows:

Model	SCS-17	SCS-24	SCS-32
Capacitance (±20%)	20 nF	37 nF	66 nF
Z (0.1 kHz)	79577 ohm	43000 ohm	24114 ohm
Z (1 kHz)	7957 ohm	4300 ohm	2411 ohm
Z (2 kHz)	3978 ohm	2150 ohm	1205 ohm
Z (5 kHz)	1591 ohm	860 ohm	482 ohm
Z (10 kHz)	795 ohm	430 ohm	241 ohm
Z (15 kHz)	530 ohm	286 ohm	161 ohm
Z (20 kHz)	397 ohm	215 ohm	121 ohm

FREQUENCY RESPONSE

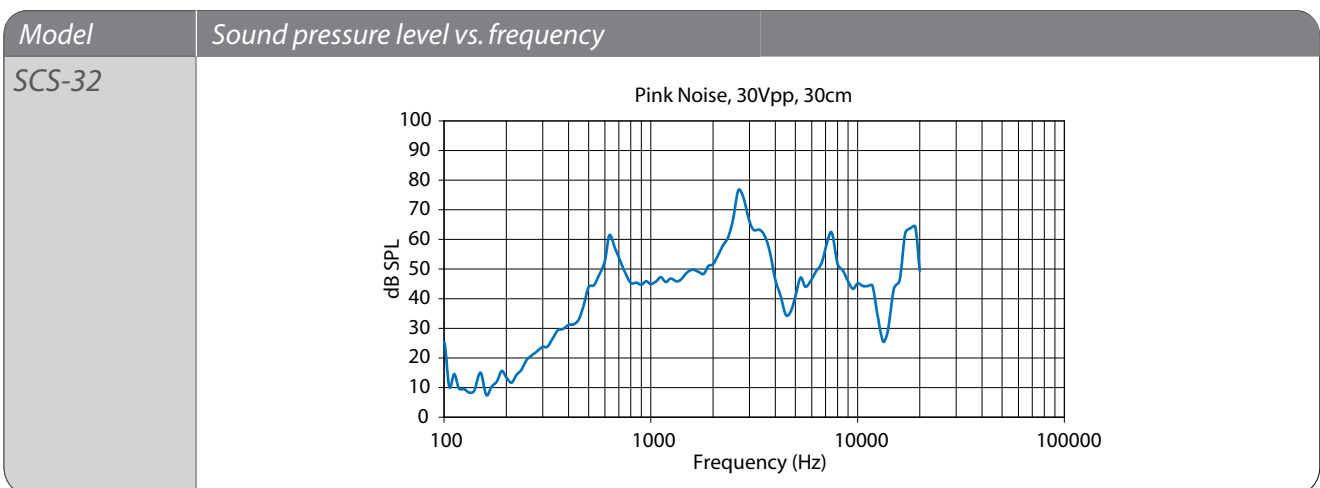
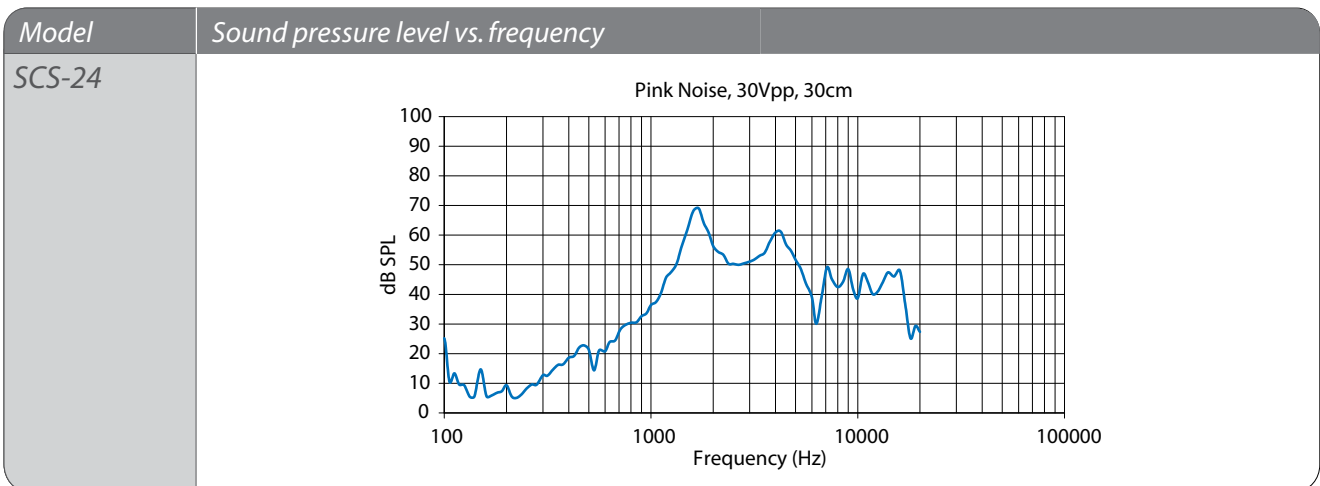
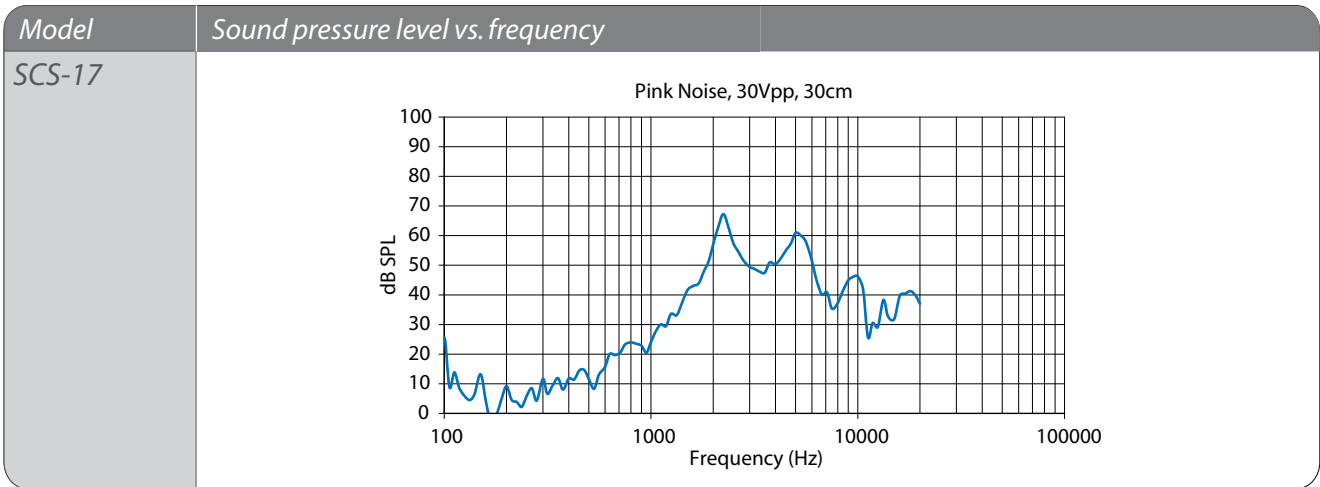

Pink noise measurements made in free air.
 The speakers were mounted in a box with dimensions 40x15x5 cm.

DIMENSIONS (All dimensions are in mm)

SCS-17-P10

Pin-version
(case in PBT)

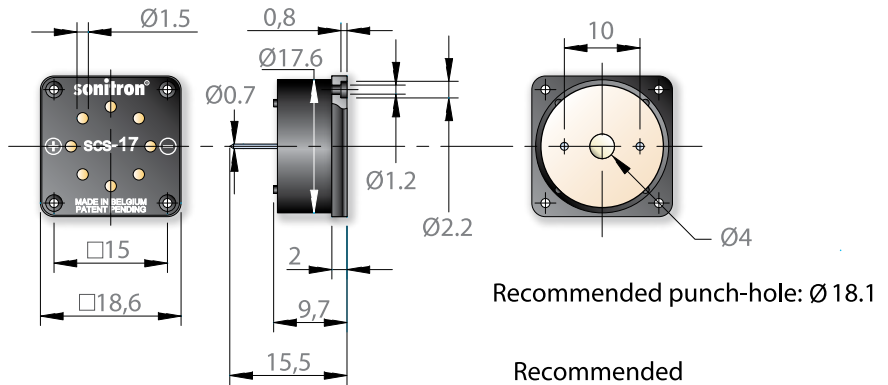

SCS-17-S

SMD-version
(case in PPS)

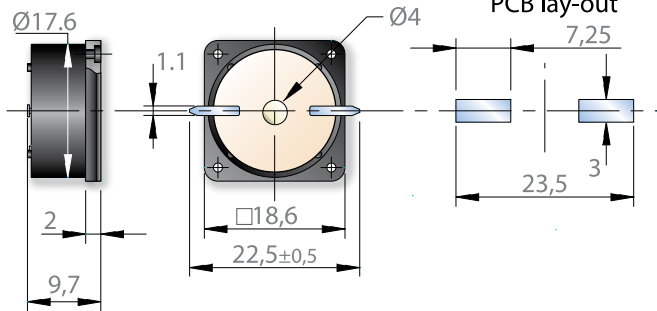

SCS-24-P10

Pin-version
(case in PBT)

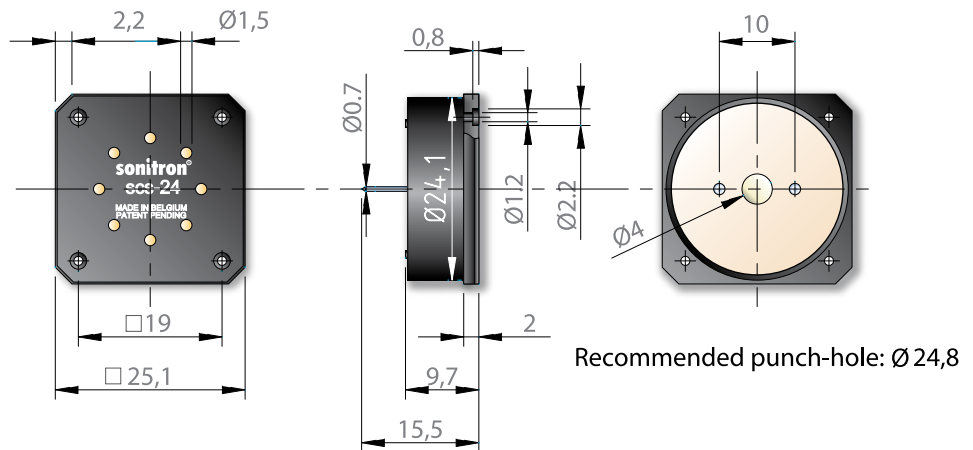

SCS-24-S

SMD-version
(case in PPS)

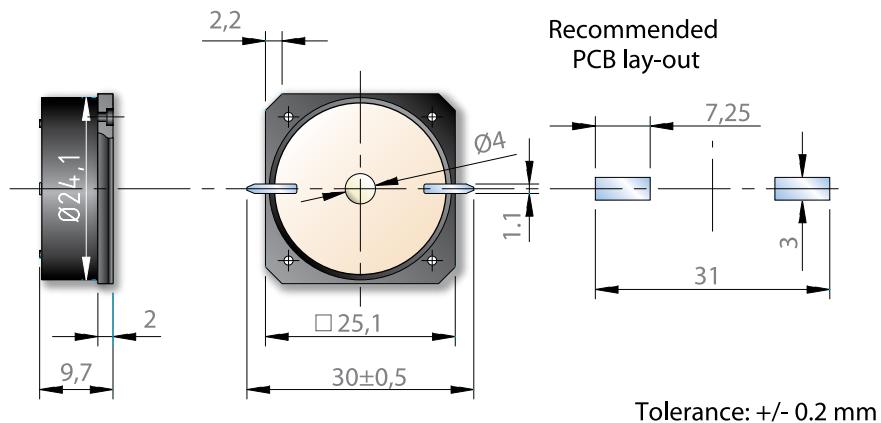

DIMENSIONS (All dimensions are in mm)

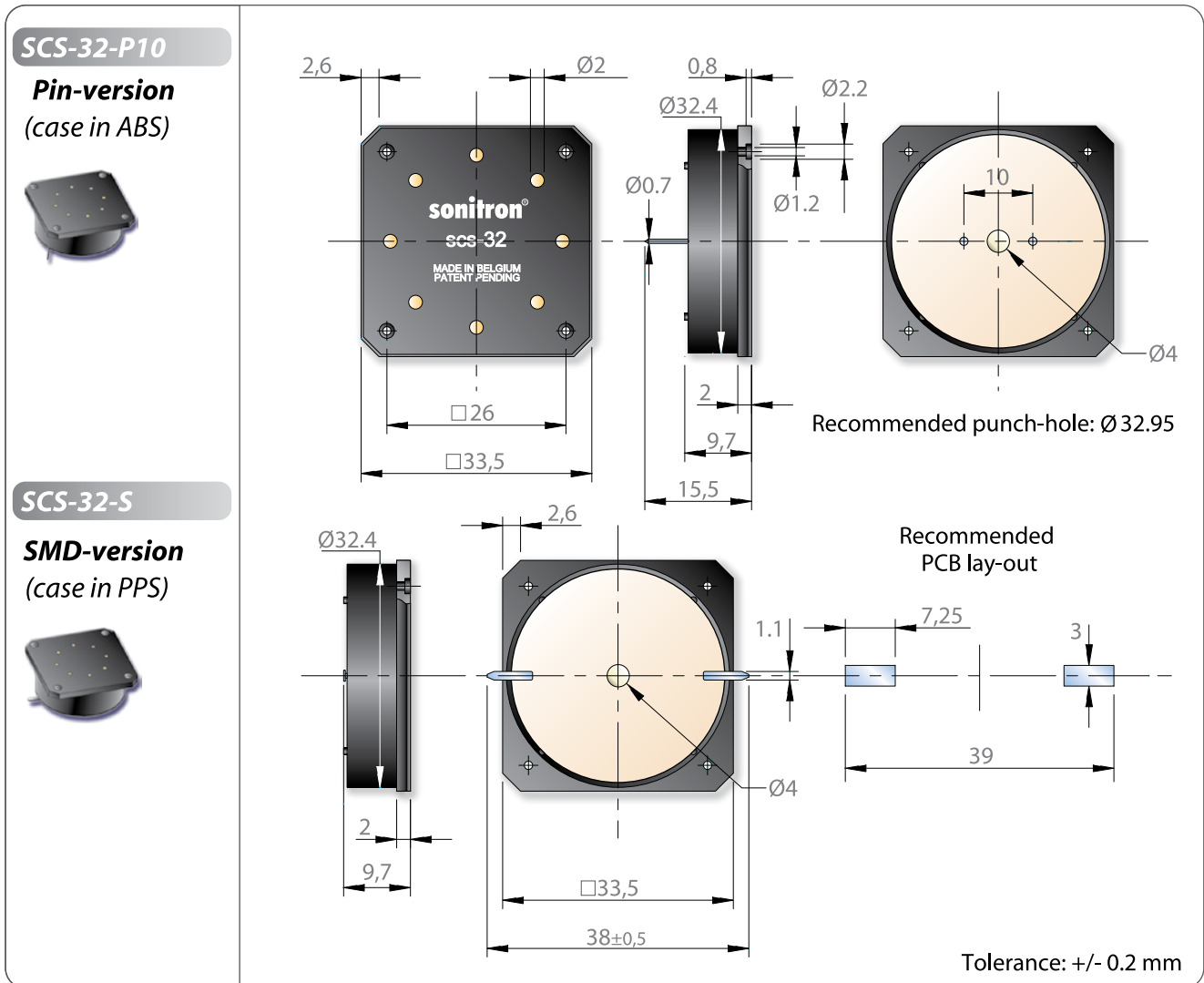

PRODUCT OPTIONS

Option Code	example	Description
SP02	SCS-32-P10/ SP02	Contains heavy duty wires (plastic insulation), connection sealed with silicone.
FP17S	SCS-24-S- FP	Acoustic stabilization Foam Patch, easy to stick. For: SCS-24-P10 SCS-24-S
FP24S	SCS-32-S- FP	Acoustic stabilization Foam Patch, easy to stick. For: SCS-32-P10 SCS-32-S

Recommended Piezo Audio Amplifiers

Sonitron production models

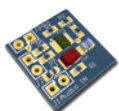

PAA-LT3469-01

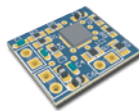

PAA-MAX-9788-01

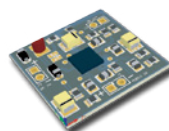

PAA-LM4960SQ-02

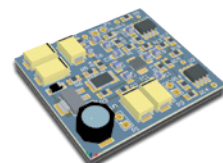

PAA-StepUpBTL-01

PRODUCT CODIFICATION

SCS ↓ Sonitron Ceramic Speaker	SCS-17 SCS-24 SCS-32 ↓ Square diameter (mm)	P S ↓ P: Pin distance (mm) S: SMD-connection
--	---	--

LIST OF AVAILABLE PRODUCT TYPES

SCS-17-P10 SCS-17-S	SCS-24-P10 SCS-24-S	SCS-32-P10 SCS-32-S
------------------------	------------------------	------------------------

PACKAGING

All speakers with through hole pins, are packed on a polystyrene board (245 L x 245 W) and sold in boxes with dimensions of 250 L x 250 W x 125 H.

Number	SCS-17 P10	SCS-24 P10	SCS-32 P10
per board	100	81	49
per box	(5x100) 500	(5x81) 405	(5x49) 245

All SMD models are packed in trays (245 L x 245 W) and sold in boxes with dimensions of 250 L x 250 W x 125 H.

Number	SCS-17-S	SCS-24-S	SCS-32-S
per board	49	42	25
per box	(7x49) 343	(5x42) 210	(6x25) 150

Dimensions of the tray and position of the SMD components of the models SCS-17-S, SCS-24-S and SCS-32-S are illustrated below:

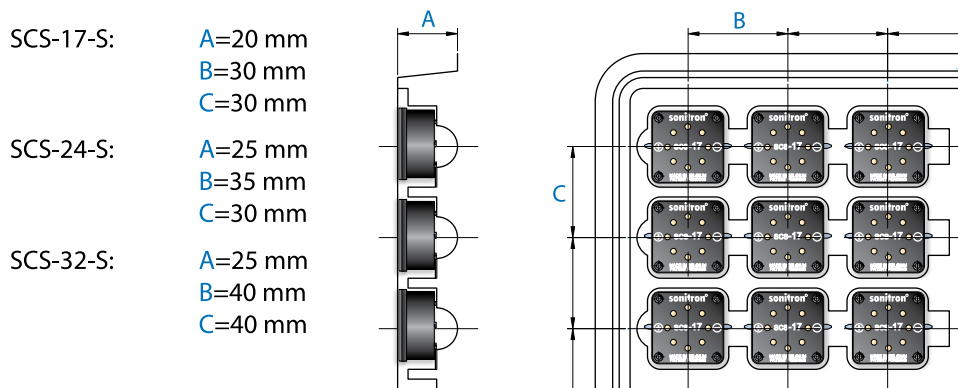

ACOUSTIC MOUNTING INSTRUCTIONS FOR SCS-SPEAKERS

- Fundamental mounting recommendations see page 110.
- The SCS speakers can be mounted in several different ways. The recommended mounting methods illustrated below are the best ways to mount all the SCS speaker models.

Soldered with pins on the PCB

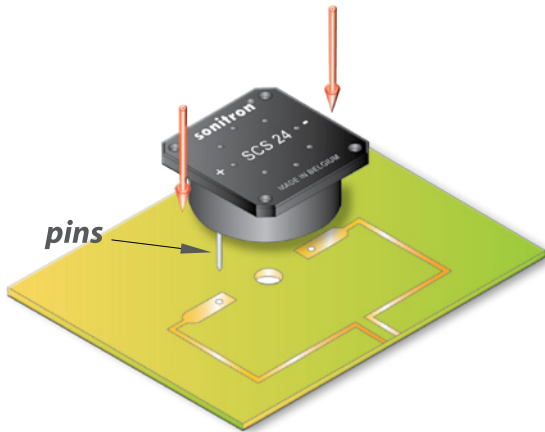

SMD soldered on the PCB

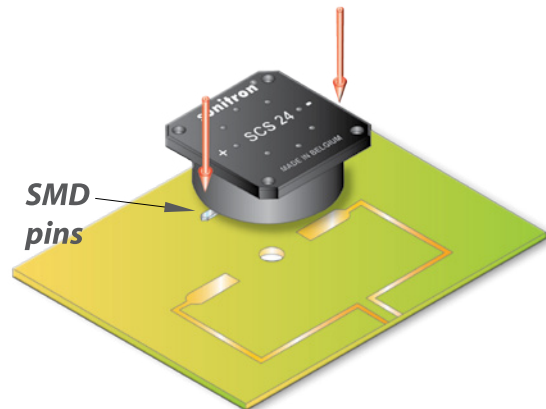

Panel mounting, secured with 4 screws

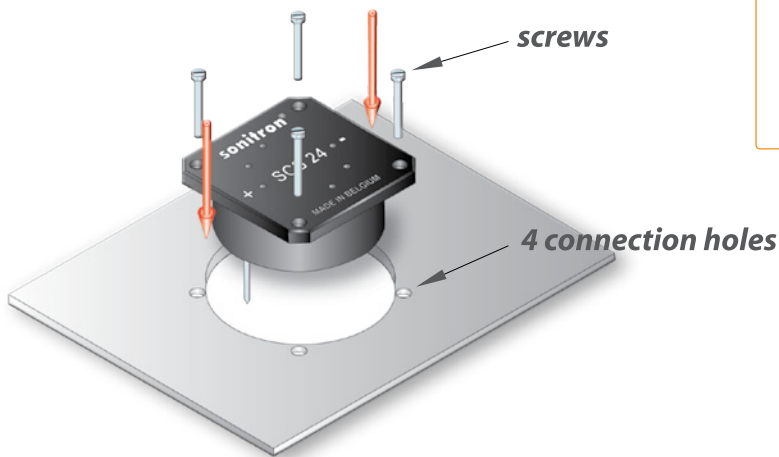

Product Options available:

- SP02
 - Foam Patch FP
- (see page 132)

When mounted on a PC-board, a central hole in the PC-board of minimum 5 mm diameter is recommended.

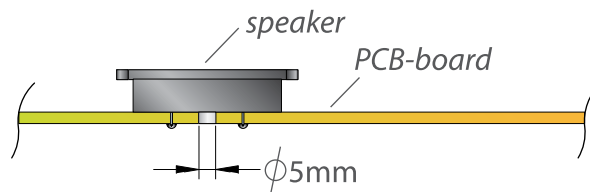

Other methods...

SPS SERIES (SONITRON Polymer/metal Speakers)



INTRODUCTION

Based on the in-house expertise in vibration characteristics of piezoceramic material and micro-acoustics, Sonitron successfully developed the SPS-series piezoceramic speakers for industrial, multimedia and automotive applications. The SPS-series is based on a completely new principle of piezoceramics and a composite polymer/metal membrane. The composite polymer/metal membrane reduces unwanted resonance peaks to provide a more even frequency response than can be achieved with conventional designs. High sound quality and low distortion guarantee perfect reproduction of music and speech.

Piezoceramic speakers offer a faster response than conventional magnet speakers because of their lower mass (no voice coil). Magnet speakers are less efficient than piezo speakers because of the losses via the voice coil. Piezoceramic speakers also feature a low weight and low energy consumption relative to their sound output levels. They do not generate an electromagnetic field, making it easier for designers to ensure that their products meet EMC requirements and regulations.

Sonitron's SPS speakers have a very flat design and are delivered with an open front. They can be used in difficult environmental conditions and applications because of resistance of the front to water, humidity, vibrations and dust.

The described models are released for applications such as mobile phone, PDA, flat LCD computer screens and computer monitors, consumer products, car audio, instrumentation, portable devices, public address systems, paging systems, etc.

SPS Series

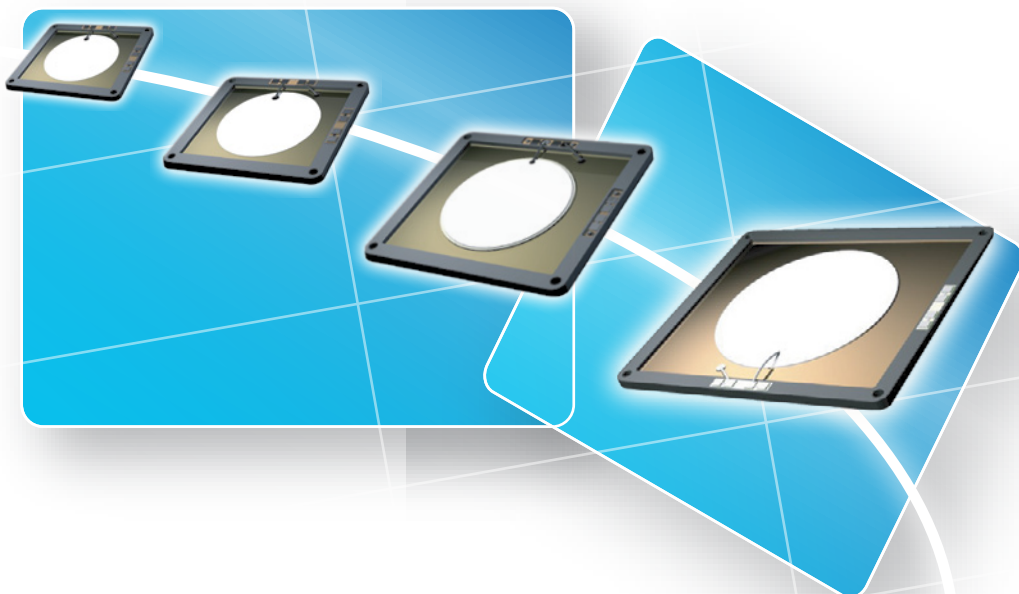

ADVANTAGES & APPLICATIONS

ADVANTAGES :

- very flat and solid construction
- dust, water- and shockproof
- resistant to temperature variations
- broad frequency range in small size
- combined use as speaker/micro
- no electro-magnetic field (EMC)
- little energy required at low frequencies
- less current consumption needed in the leads to the speaker
- 60% higher acoustic output for smaller speakers compared to electrodynamic speakers
- low weight
- low distortion
- high impedance
- can be driven directly by IC

APPLICATIONS :

- home equipment & domotics
- communication equipment
- talking buzzer & door bell
- computer equipment
- cars, busses and trains
- vending machines
- multimedia equipment
- industrial equipment
- portable voice recorders
- paging systems
- public address systems
- instrumentation
- mobile phone
- car audio system

SPECIFICATIONS

Model	Operating voltage (Vac pp)	Frequency range (Hz)	Max. SPL dB @ 1m, average 4 points	Applications	Capacitive load	Dimensions mm (LxWxH)
SPS-2220-03	1-24	700-20000	85*	GSM, GPS, MP3, camera,...	70nF	22x20x2
SPS-3530-03	5-60	700-20000	81	PDA, GPS, notebooks,...	220nF	43.5x39x2
SPS-4640-03	5-60	400-20000	83	PDA, GPS, notebooks,...	225nF	50x43.6x2
SPS-6555-03	5-60	300-20000	83	Multimedia,...	480nF	65x55x2
SPS-8770-03	5-60	200-20000	84	Computers,...	580nF	87x70x2

*@10 cm, designed for headphone applications!

IMPEDANCE

Theoretical the main impedance of the piezo speakers is a capacitive reactance and follows an asymptotic function.

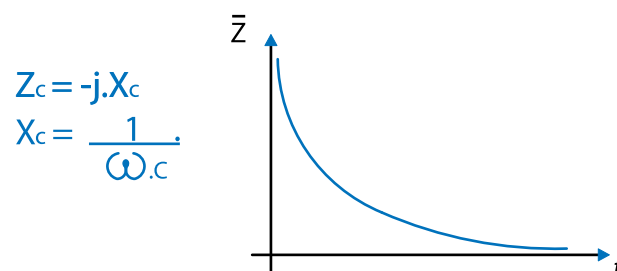

The typical practical impedance values ($\pm 20\%$) for frequencies of 100 Hz up to 20 kHz of our speakers are as follows:

Model	SPS-2220-03	SPS-3530-03	SPS-4640-03	SPS-6555-03	SPS-8770-03
Capacitance ($\pm 20\%$)	70 nF	220 nF	225 nF	480 nF	580 nF
Z @ 100 Hz	22360 ohm	5714 ohm	6210 ohm	3845 ohm	2314 ohm
Z @ 1 kHz	2162 ohm	603 ohm	680 ohm	445 ohm	266 ohm
Z @ 2 kHz	1183 ohm	311 ohm	360 ohm	223 ohm	133 ohm
Z @ 5 kHz	497 ohm	127 ohm	143 ohm	92 ohm	54 ohm
Z @ 10 kHz	245 ohm	65 ohm	73 ohm	45 ohm	28 ohm
Z @ 15 kHz	168 ohm	43 ohm	49 ohm	31 ohm	19 ohm
Z @ 20 kHz	125 ohm	32 ohm	37 ohm	23 ohm	14 ohm

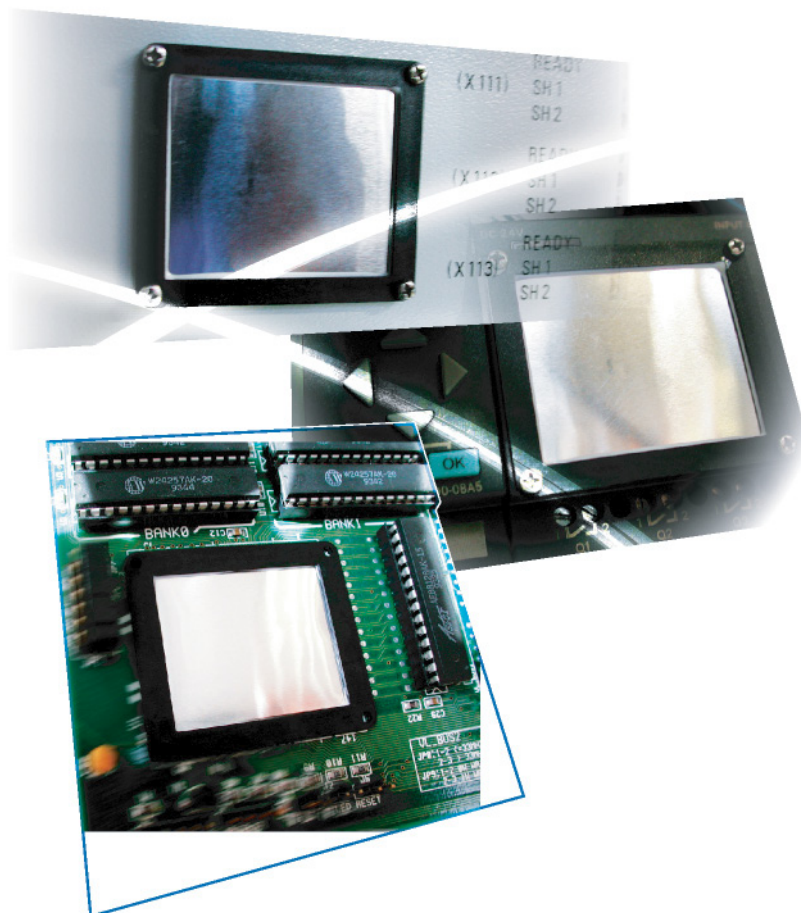

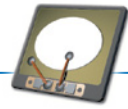

SPS-2220-03



Sonitron's latest slim line profile speaker, the SPS-2220-03, is the result of ten years intensive research and development work. With a thickness of only 1 mm and dimensions of 20x22 mm, this small multifunctional speaker/microphone is ideal for use in GPS, MP3, camera's, mobile phones,... It is distortion free and has excellent sound reproduction. Considering its extremely good voice clarity it definitely is the new speaker generation for the mobile phone industry.

SPECIFICATIONS

Frequency Range :	700 Hz-20 kHz
Max SPL @ 10 cm, 24Vpp: (average at 4-point)	85 dB
Distortion (%THD): (80dB @ 5 cm, average @ 4-point)	≤1%
Sensitivity: (SPL @ 10cm for 1Vrms, average at 4-point : 800Hz, 1kHz, 1.5kHz, 2kHz)	63 dB
Capacitance (+/- 20%):	70 nF
Impedance @ 1kHz (+/-20%):	2.16 kohm
Operating Voltage:	1Vpp-24Vpp
Weight:	0.4g
Operating Temperature:	-20°C to 60°C
Storage Temperature:	-40°C to 60°C
Case material:	PC
Standard color:	Black

speaker mounted on plexi plate of 5 x 5cm in closed box of 40 x 15 x 5cm

FREQUENCY RESPONSE

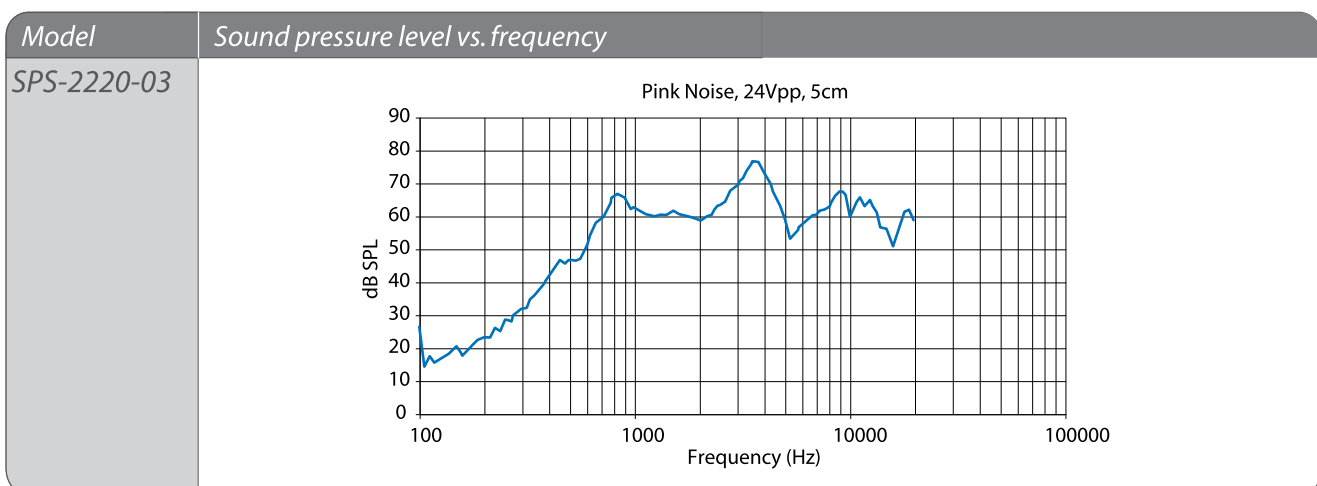

DIMENSIONS (all dimensions are in mm)

SPS-2220-03

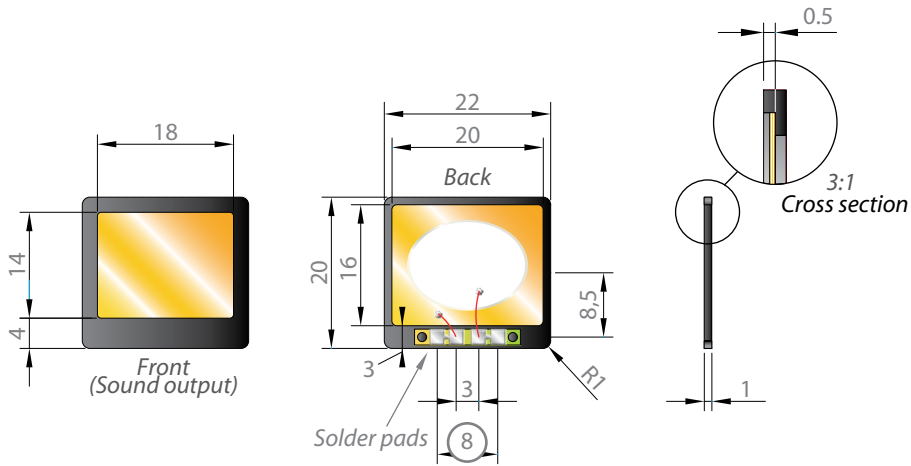

Tolerance: +/- 0.2mm mm

Recommended Piezo Audio Amplifiers

Integrated Circuits

Maxim
MAX9788

Texas Instruments
TPA2100P1

Linear technology
LT3469

Sonitron production models

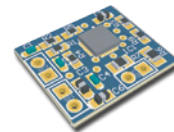

PAA-MAX-9788-01

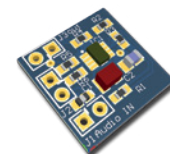

PAA-LT3469-01

SPS-3530-03

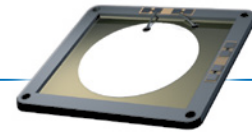

The electronics industry still is a very demanding industry which requires more and more flat and small components. Therefore Sonitron developed this new flat piezoceramic speaker. With a thickness of only 2 mm and dimensions of 39x43.5 mm, this small multifunctional speaker/microphone is ideal for use in portable electronic devices (PDA, GPS, MP3,...), notebooks and consumer products.

SPECIFICATIONS

Frequency Range :	700 Hz - 20 kHz
Max SPL @ 1 m, 60 Vpp: (average at 4-point)	81 dB
Distortion (%THD): (80dB @ 5 cm, average @ 4-point)	≤1.5%
Sensitivity: (SPL @ 10cm for 1Vrms, average @ 4-point : 800Hz, 1kHz, 1.5kHz, 2kHz)	73 dB
Capacitance (+/- 20%):	220 nF
Impedance @ 1kHz (+/-20%):	603 ohm
Operating Voltage:	5-60 Vpp
Weight:	2.4g
Operating Temperature:	-20°C to 60°C
Storage Temperature:	-40°C to 60°C
Case material:	PC
Standard color:	Black

speaker mounted in closed box of 40 x 15 x 5cm

FREQUENCY RESPONSE

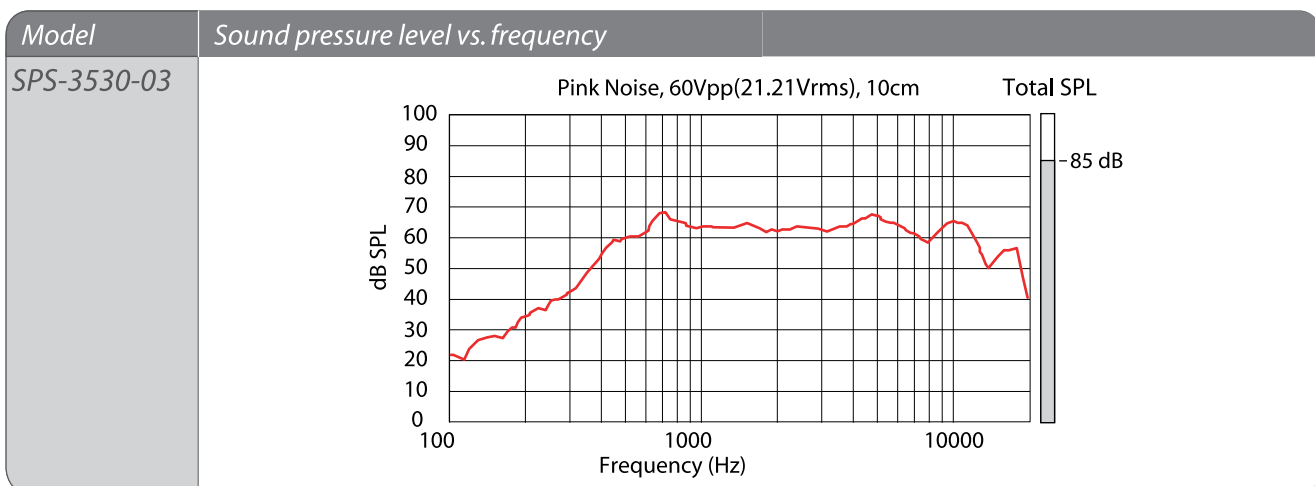

DIMENSIONS (all dimensions are in mm)

SPS-3530-03

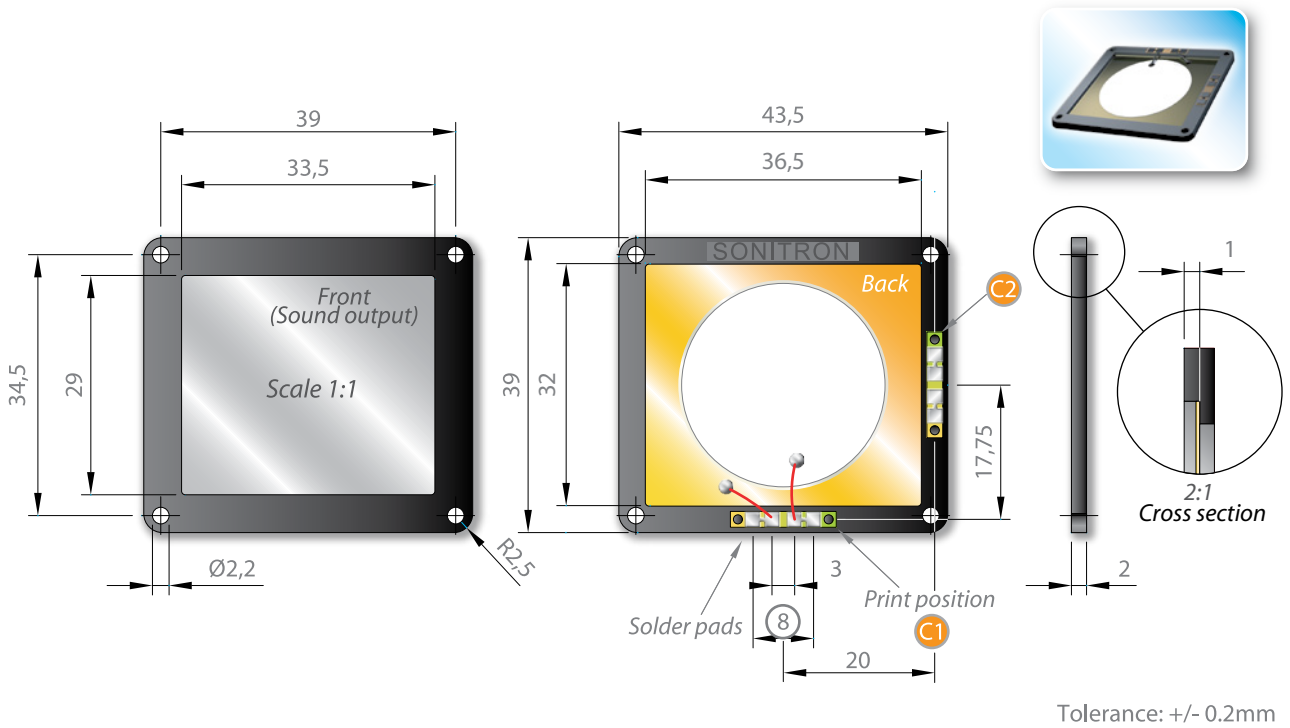

Recommended Piezo Audio Amplifiers (see page 104, 105, 106)

Integrated Circuits

Maxim
MAX9788

National semiconductor
LM4960

Texas Instruments
TPA2100P1

Sonitron production models

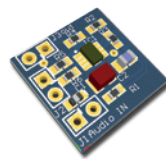

PAA-LT3469-01

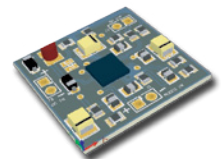

PAA-LM4960SQ-02

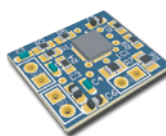

PAA-MAX-9788-01

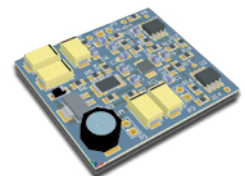

PAA-StepUpBTL-01

SPS-4640-03

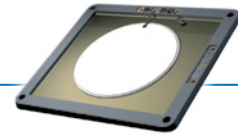

The electronics industry still is a very demanding industry which requires more and more flat and small components. Therefore Sonitron developed this new flat piezoceramic speaker. With a thickness of only 2 mm and dimensions of 43.6x50 mm this small multifunctional speaker/microphone is ideal for use in portable electronic devices (PDA, GPS, MP3,...), notebooks and consumer products.

SPECIFICATIONS

Frequency Range :	400 Hz - 20 kHz
Max SPL @ 1 m, 60 Vpp: (average @ 4-point)	83 dB
Distortion (%THD): (80dB @ 5 cm, average @ 4-point)	≤1.5%
Sensitivity: (SPL @ 10cm for 1Vrms, average @ 4-point : 800Hz, 1kHz, 1.5kHz, 2kHz)	72 dB
Capacitance (+/- 20%):	225 nF
Impedance @ 1kHz (+/-20%):	680 ohm
Operating Voltage:	5-60 Vpp
Weight:	2.8g
Operating Temperature:	-20°C to 60°C
Storage Temperature:	-40°C to 60°C
Case material:	PC
Standard color:	Black

speaker mounted in closed box of 40 x 15 x 5cm

FREQUENCY RESPONSE

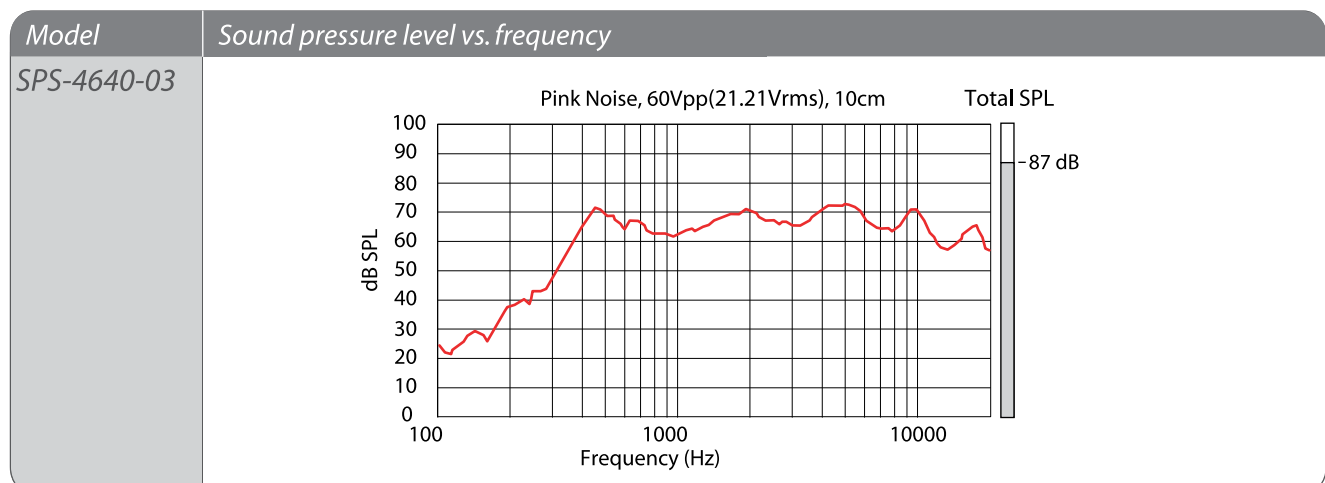

DIMENSIONS (all dimensions are in mm)

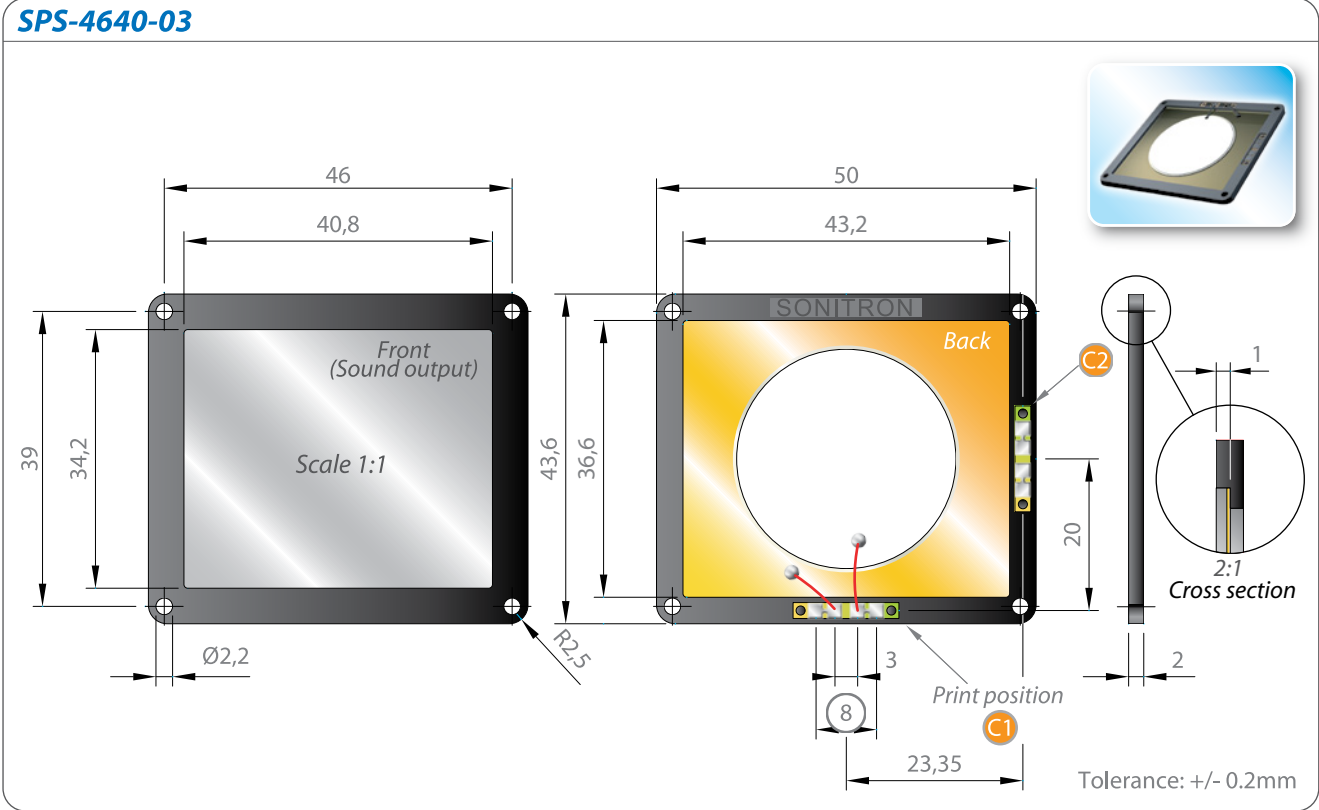

Recommended Piezo Audio Amplifiers (see page 104, 105, 106)

Integrated Circuits

Maxim
MAX9788

National semiconductor
LM4960

Texas Instruments
TPA2100P1

Sonitron production models

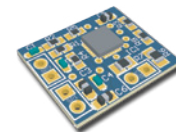

PAA-MAX-9788-01

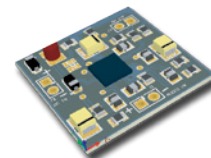

PAA-LM4960SQ-02

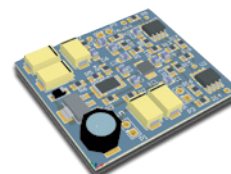

PAA-StepUpBTL-01

SPS-6555-03



The new SPS-6555-03 is designed for applications where the space is limited and a high sound quality is required. This new speaker model features a broad frequency range combined with small dimensions which makes them ideal for multimedia applications.

SPECIFICATIONS

Frequency Range :	300 Hz - 20 kHz
Max SPL @ 1 m, 60 Vpp: (average @ 4-point)	83 dB
Distortion (%THD): (80dB @ 1m, average @ 4-point)	≤1.5%
Sensitivity: (SPL @ 10cm for 1Vrms, average @ 4-point : 800Hz, 1kHz, 1.5kHz, 2kHz)	73 dB
Capacitance (+/- 20%):	480 nF
Impedance @ 1kHz (+/-20%):	333 ohm
Operating Voltage:	5-60 Vpp
Weight:	5g
Operating Temperature:	-20°C to 60°C
Storage Temperature:	-40°C to 60°C
Case material:	PC
Standard color:	Black

speaker mounted in closed box of 40 x 15 x 5cm

FREQUENCY RESPONSE

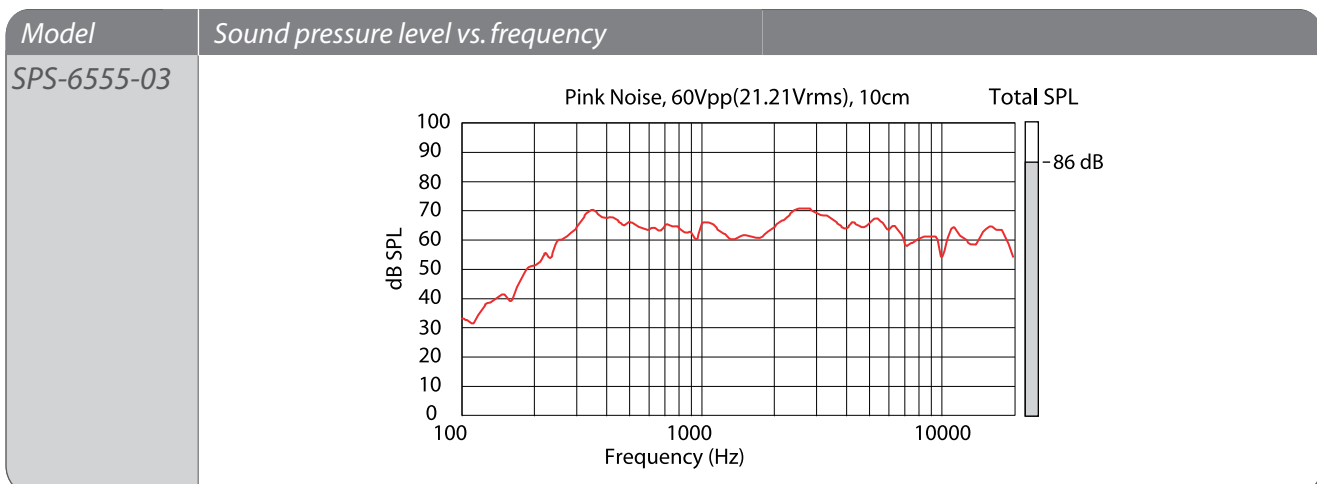

DIMENSIONS (all dimensions are in mm)

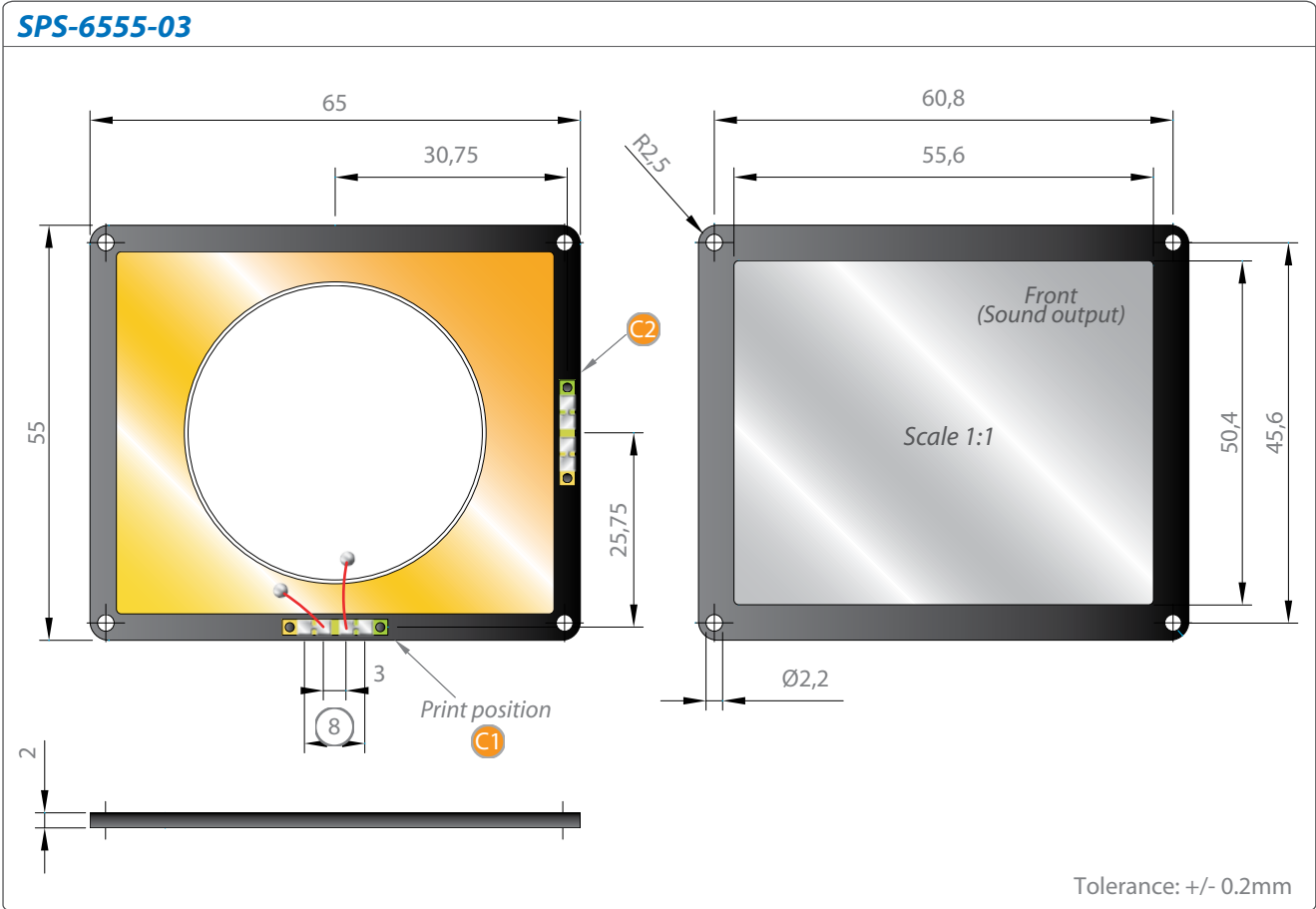

Recommended Piezo Audio Amplifiers (see page 104, 105, 106)

Integrated Circuits

Maxim
MAX9788

National semiconductor
LM4960

Texas Instruments
TPA2100P1

Sonitron production models

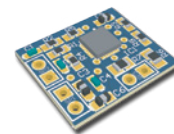

PAA-MAX-9788-01

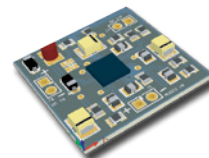

PAA-LM4960SQ-02

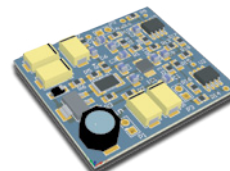

PAA-StepUpBTL-01

SPS-8770-03

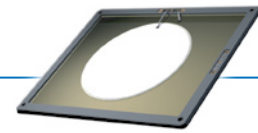

The SPS-8770-03 is the largest version of our piezo speakers, with a thickness of only 2 mm. This model is extremely suitable for flat devices when high sound output and broad frequency range are required. Low weight and easy mounting requirements are the extreme advantages of this speaker. Compared with conventional designs the speaker also has less current consumption.

SPECIFICATIONS

Frequency Range :	200 Hz - 20 kHz
Max SPL @ 1 m, 60 Vpp: (average @ 4-point)	84 dB
Distortion (%THD): (80dB @ 5 cm, average @ 4-point)	≤1.5%
Sensitivity: (SPL @ 10cm for 1Vrms, average @ 4-point : 800Hz, 1kHz, 1.5kHz, 2kHz)	74 dB
Capacitance (+/- 20%):	580 nF
Impedance @ 1kHz (+/-20%):	266 ohm
Operating Voltage:	5-60 Vpp
Weight:	7.3g
Operating Temperature:	-20°C to 60°C
Storage Temperature:	-40°C to 60°C
Case material:	PC
Standard color:	Black

speaker mounted in closed box of 40 x 15 x 5cm

FREQUENCY RESPONSE

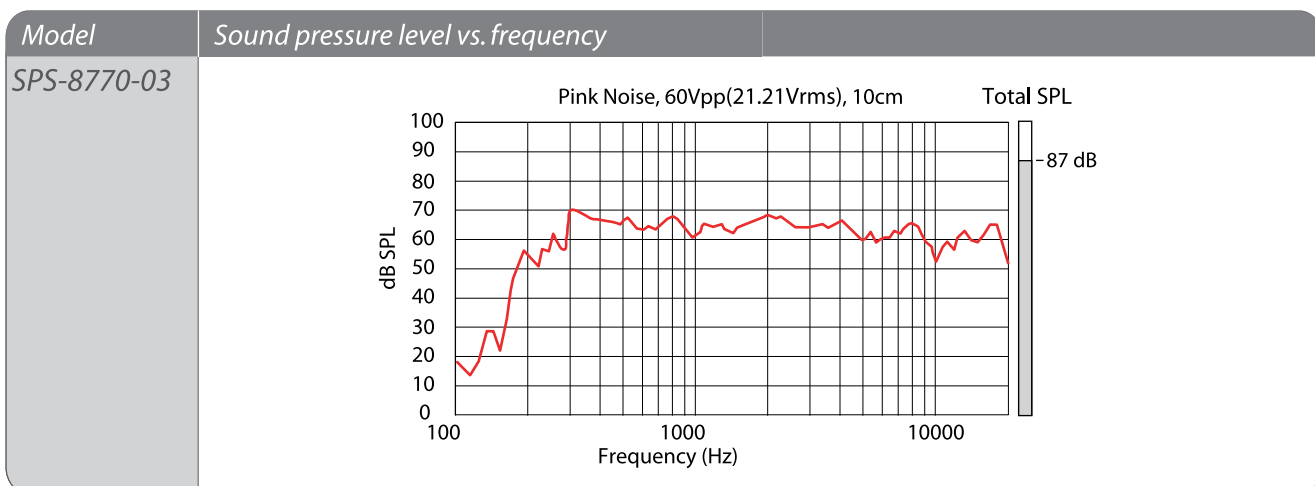

DIMENSIONS (all dimensions are in mm)

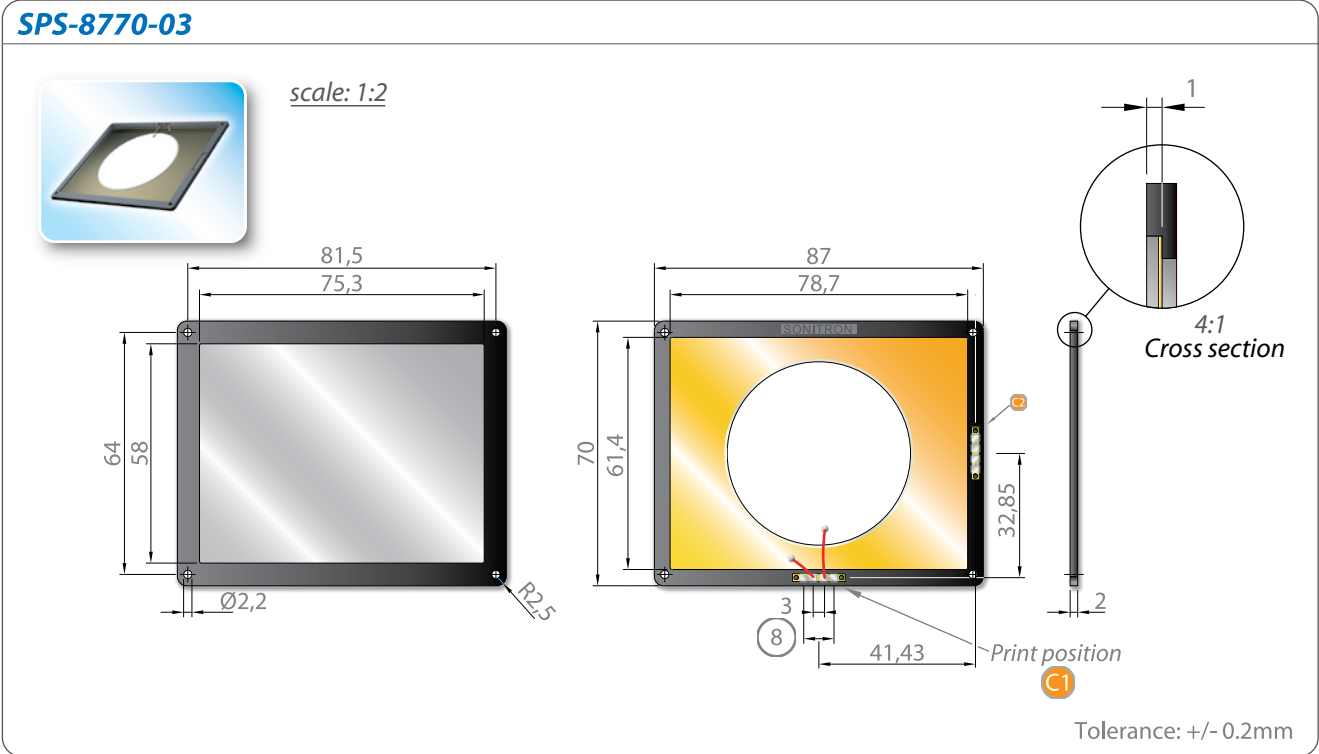

Recommended Piezo Audio Amplifiers (see page 104, 105, 106)

Integrated Circuits

Maxim
MAX9788

National semiconductor
LM4960

Texas Instruments
TPA2100P1

Sonitron production models

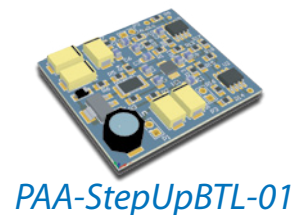
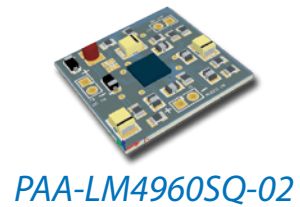
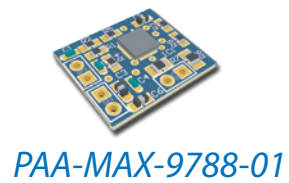

PRODUCT CODIFICATION

<p>SPS</p> <p>↓</p> <p>Sonitron Polymer/metal Speaker</p>	<p>2220-03 3530-03 4640-03 6555-03 8770-03</p>	<p>C1 or C2</p> <p>↓</p> <p>C1: Position of solder pads C2: Position of solder pads</p>	
---	--	---	--

LIST OF AVAILABLE PRODUCT TYPES

SPS-2220-03	SPS-3530-03-C1 SPS-3530-03-C2	SPS-4640-03-C1 SPS-4640-03-C2	SPS-6555-03-C1 SPS-6555-03-C2	SPS-8770-03-C1 SPS-8770-03-C2
-------------	----------------------------------	----------------------------------	----------------------------------	----------------------------------

PACKAGING

The SPS-2220-03/3530-03/4640-03/6555-03/8770-03 are packed in trays (245 L x 245 W) and sold in boxes with dimensions of 250 L x 250 W x 125 H.

Number	SPS-2220-03	SPS-3530-03	SPS-4640-03	SPS-6555-03	SPS-8770-03
per tray	81	25	16	9	6
per box	(81x70) 5670	(25x40) 1000	(16x40) 640	(9x40) 360	(6x40) 240

Dimensions of the tray and position of the SPS-speakers 2022-03/3035-03/4640-03/8770-03/SPS-27-01 are illustrated below:

SPS-2220-03	A=1.5 mm B=26 mm C=26 mm
SPS-3530-03	A=3 mm B=47.5 mm C=47.5 mm
SPS-4640-03	A=3 mm B=60 mm C=60 mm
SPS-6555-03	A= 3mm B=68.5mm C=75.5mm
SPS-8770-03	A=3 mm B=78 mm C=120 mm

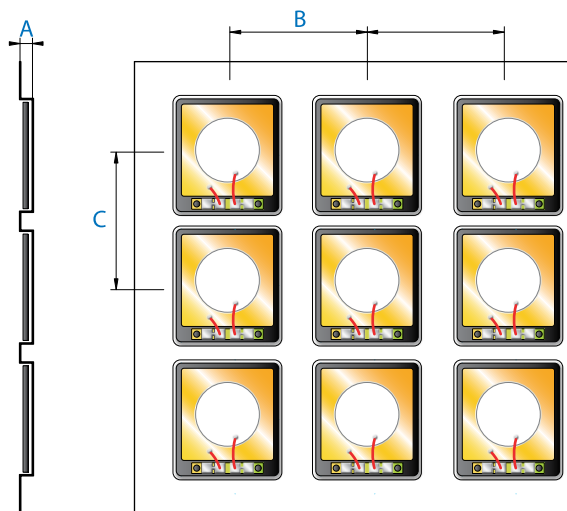

ACOUSTIC MOUNTING INSTRUCTIONS FOR SPS-SPEAKERS

- Fundamental mounting recommendations see page 110.
- The SPS speakers can be mounted in several different ways. The mounting methods, illustrated below, are recommended to mount all the SPS speaker models. Please keep in mind that not too much mechanical stress is placed on the frame of the piezoceramic speaker after mounting.

Mounted with glue or silicone

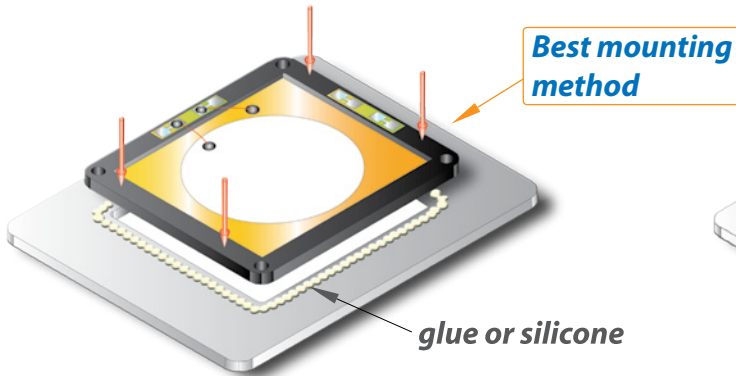

Mounted with slot groove



Mounted with screws

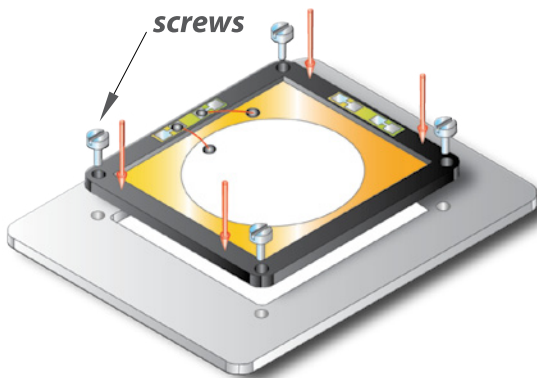

Plastic deformation method (Ultrasonic)

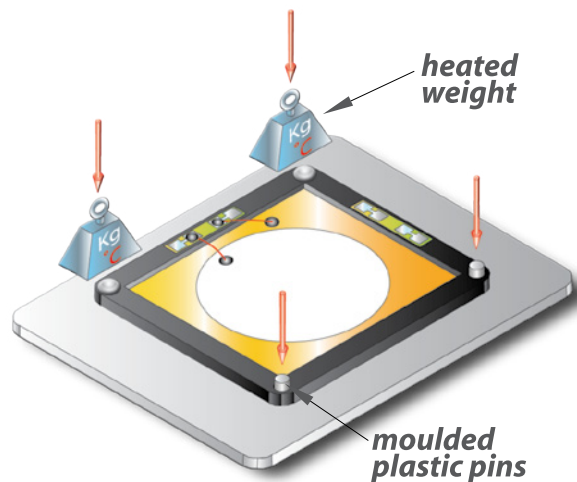

Other methods...

Speaker cloth fabric

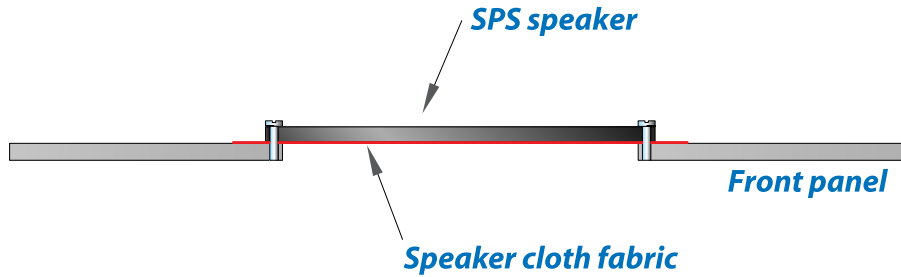

Front holes

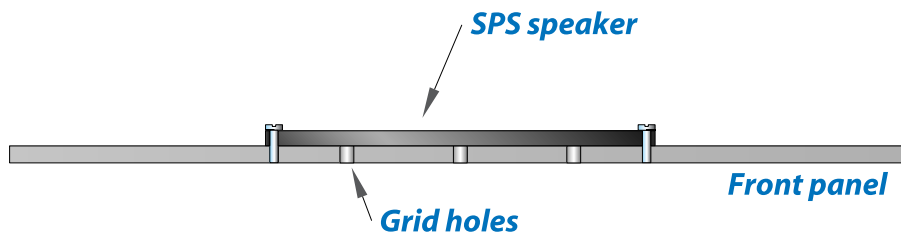

Front holes of 1 mm Ø for model SPS-2220-03
 2 mm Ø for model SPS-3530-03
 2 mm Ø for model SPS-4640-03
 2 mm Ø for model SPS-8770-03

Distance front holes d=3 mm for model SPS-2220-03
 d=5 mm for model SPS-3530-03
 d=5 mm for model SPS-4640-03
 d=10 mm for model SPS-S8770-03

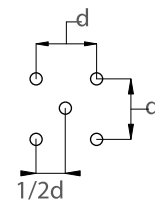

*Other designs of the hole pattern (grids) are also suitable. (SPS-2220-03, SPS-3530-03)

grid examples

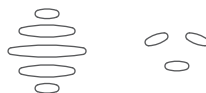

FUNDAMENTAL ACOUSTIC MOUNTING RECOMMENDATIONS

Important note:

Piezoceramic speakers produce sound by the forward and backward movement of a flat membrane. During this movement the membrane creates an air pressure wave in front and at the backside of the membrane. A forward movement will create a slight overpressure at the frontside and a slight underpressure at the backside and vice versa. It is therefore important that the front and backside are acoustically isolated from each other to avoid air pressure cancellation and consequently a serious reduction of the sound output.

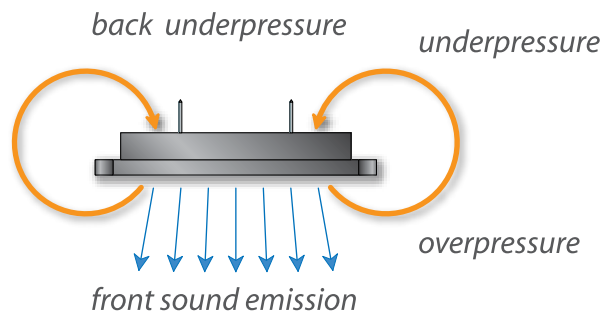

When a speaker is mounted in a panel or in the wall of a housing, the front side is acoustically isolated from the backside.

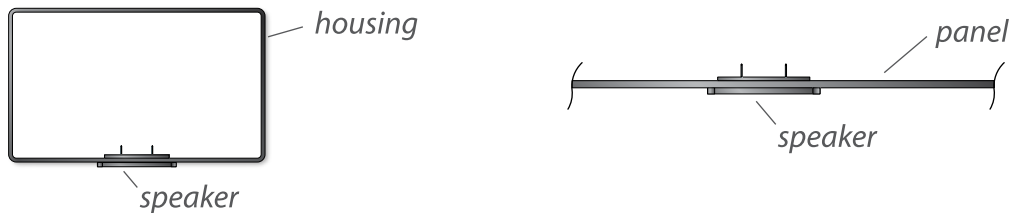

BLUE LINE SPS SERIES (Sonitron Polymer/metal Speakers)

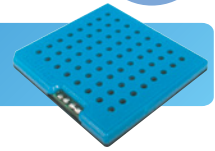

SPS-29/41/53/68-T00 Piezoceramic Audio Speaker

- louder* ✓
- broad frequency range* ✓
- fast and easy mountable* ✓
- flat and solid construction* ✓
- dust, water-and shockproof* ✓
- very small current consumption* ✓

Blue Line SPS series

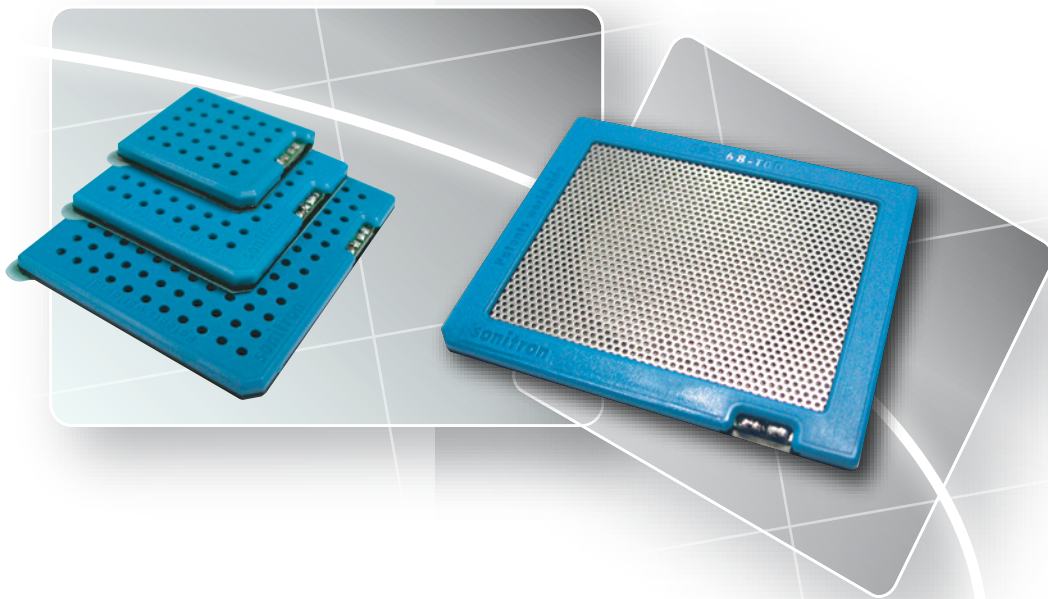

INTRODUCTION

The **Blue line SPS Piezoceramic speaker series** are designed for a broad range of applications.

Equipped with a high power adhesive tape and soldering connection pads the speaker is ready for easy mounting and fast production in every application.

These series are reproducing sound signals at very low distortion (below 1%) and broad frequency range. The casing is designed to avoid sound wave reflection in the air outlet.

The power consumption and current drain are extremely low over the entire frequency response range.

Patented technology guarantees a slim line free form factor.



ADVANTAGES & APPLICATIONS

ADVANTAGES :

- very flat and solid construction
- dust, water- and shockproof
- resistant to temperature variations
- broad frequency range in small size
- combined use as speaker/micro
- no electro-magnetic field (EMC)
- little energy required at low frequencies
- less current consumption needed in the leads to the speaker
- 60% higher acoustic output for smaller speakers compared to electrodynamic speakers
- low weight
- low distortion
- high impedance
- can be driven directly by IC

APPLICATIONS :

- GSM, GPS, PDA
- home equipment & domotics
- communication equipment
- talking buzzer & door bell
- computer equipment
- cars, busses and trains
- vending machines
- multimedia equipment
- industrial equipment
- portable voice recorders
- paging systems
- public address systems
- instrumentation
- cellular phone
- car audio system

SPECIFICATIONS *(Transducer)*

Model	SPS-29-T00	SPS-41-T00	SPS-53-T00	SPS-68-T00
Frequency Range :	1KHz - 20 kHz	450Hz - 20 kHz	300Hz - 20 kHz	250Hz - 20 kHz
Max SPL @ 10 cm, 60 Vpp:	86 dB	90 dB	93 dB	93 dB
Distortion (%THD):	≤1%	≤1%	≤1%	≤1%
Capacitance (+/- 20%):	480 nF	880 nF	960 nF	1160 nF
Max. voltage PP, sine wave/RMS:	60Vpp/21.21(V _{RMS})	60Vpp/21.21(V _{RMS})	60Vpp/21.21(V _{RMS})	60Vpp/21.21(V _{RMS})
Weight:	3.1g	5.7g	10.1g	21 g
Operating Temperature:	-20°C to 60°C	-20°C to 60°C	-20°C to 60°C	-20°C to 60°C
Storage Temperature:	-40°C to 60°C	-40°C to 60°C	-40°C to 60°C	-40°C to 60°C
Case material:	PC	PC	PC	PC + RVS grid

POWER CONSUMPTION

The average power consumption of the new SPS-series can be calculated by multiplying the RMS-voltage and RMS-current.

The **RMS-voltage** (V_{RMS}) is defined by the input signal. The used signal is a standard pink noise signal with a value of $10,6/21,21 V_{RMS}$. This signal has the same energy as a sine wave of $30/60V_{pp}$.

Pink noise is an electronic signal that carries equal energy in all octaves (or similar log bundles) over the complete audio frequency range.

The **RMS-current** (I_{RMS}) is measured with a true rms multimeter (Fluke 87V) in series with the speaker. A piezo speaker can mainly be seen as a capacitive load and therefore there will be no DC-current consumption. The only current consumption will be of the AC-current component.

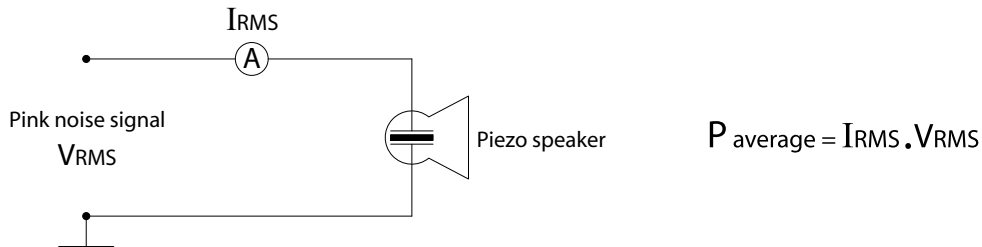

Model	10.6 V_{RMS} (30 Vpp sine) $I_{RMS} = mA$	21.21 V_{RMS} (60 Vpp sine) $I_{RMS} = mA$
SPS-29-T00	0,25 Watt (= 24mA.10,6V)	1,00 Watt (= 47mA.21,21V)
SPS-41-T00	0,48 Watt (= 45mA.10,6V)	1,87 Watt (= 88mA.21,21V)
SPS-53-T00	0,78 Watt (= 74mA.10,6V)	3,05 Watt (= 144mA.21,21V)
SPS-68-T00	1.38 Watt (= 130mA.10,6V)	5.51 Watt (= 260mA.21,21V)

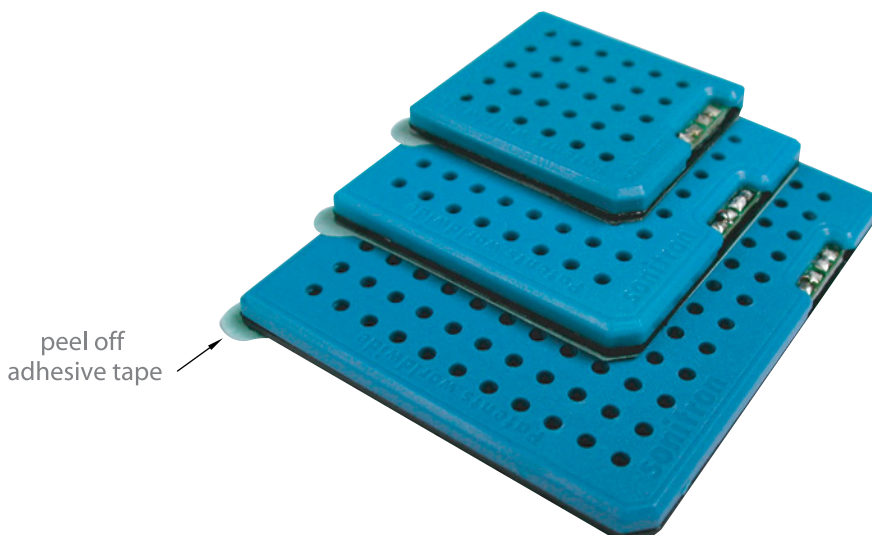

FREQUENCY RESPONSE

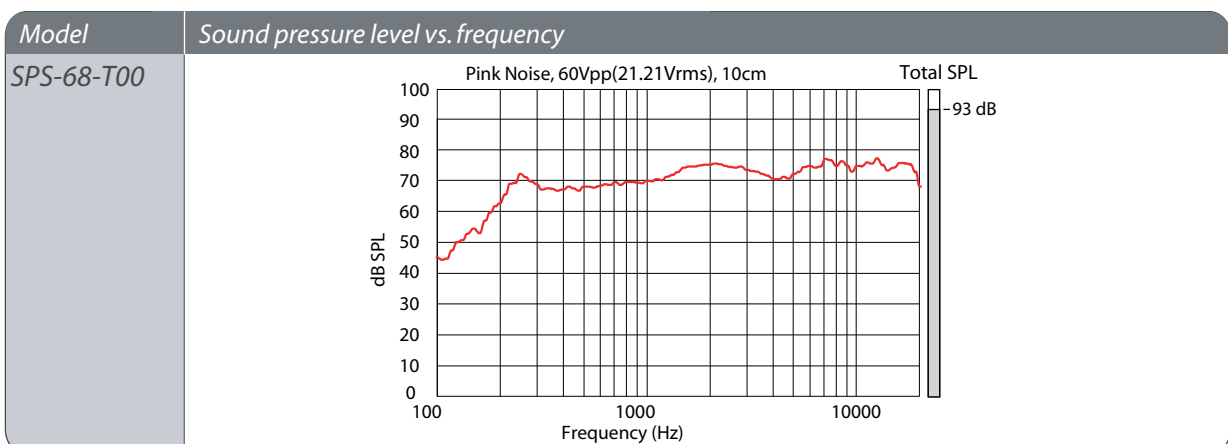
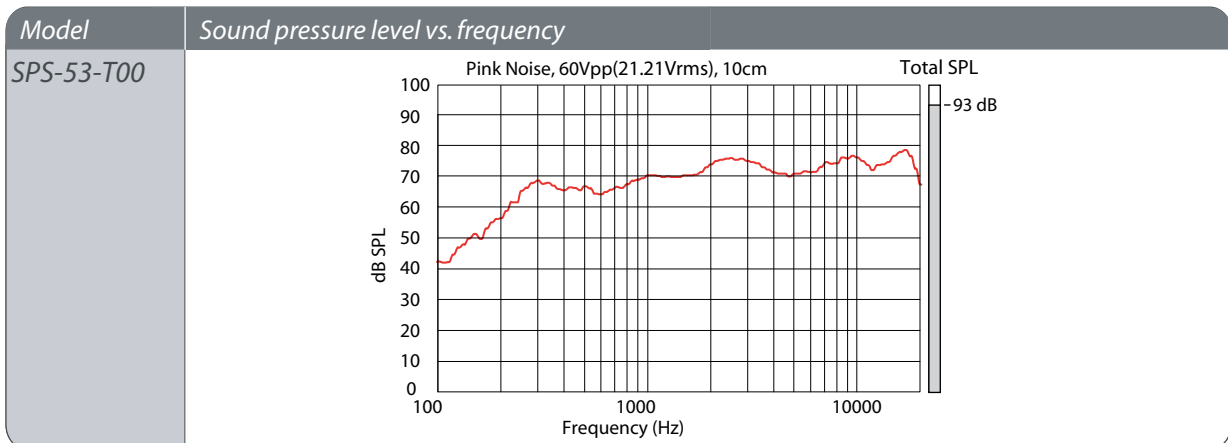
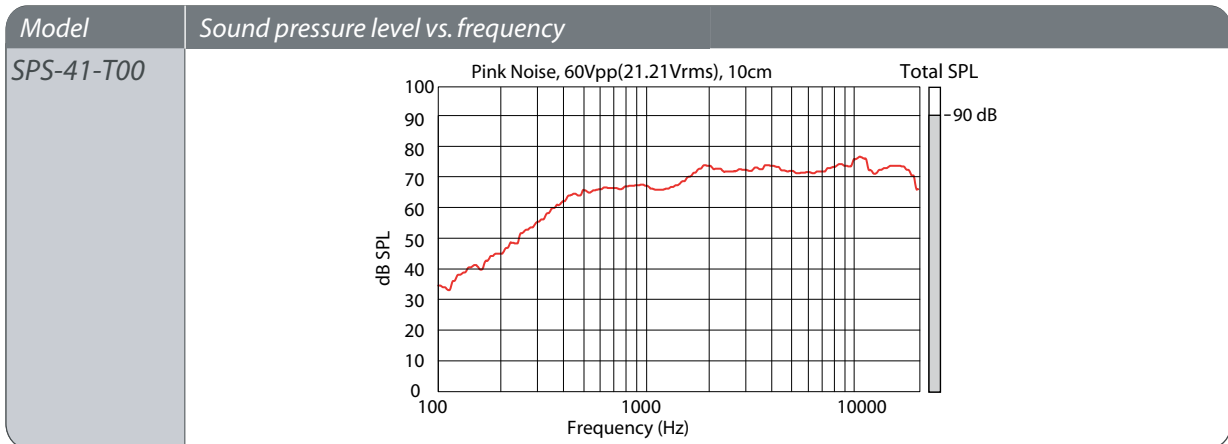
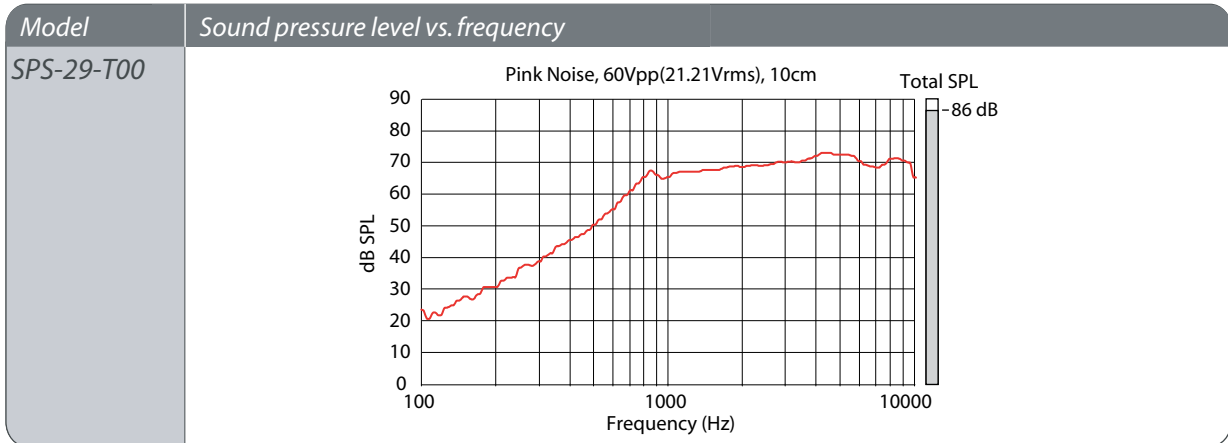

DIMENSIONS

SPS-29-T00

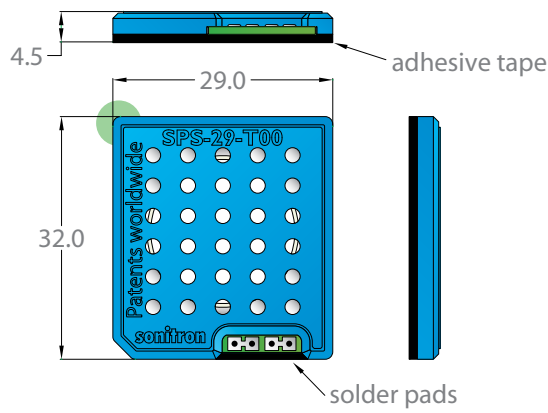

A Blue speaker backside for easy production handling

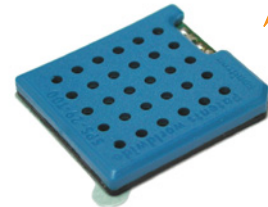

Scale:
1:1

SPS-41-T00

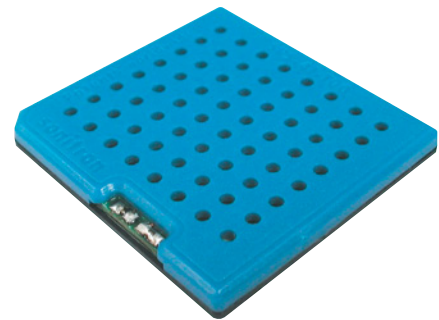
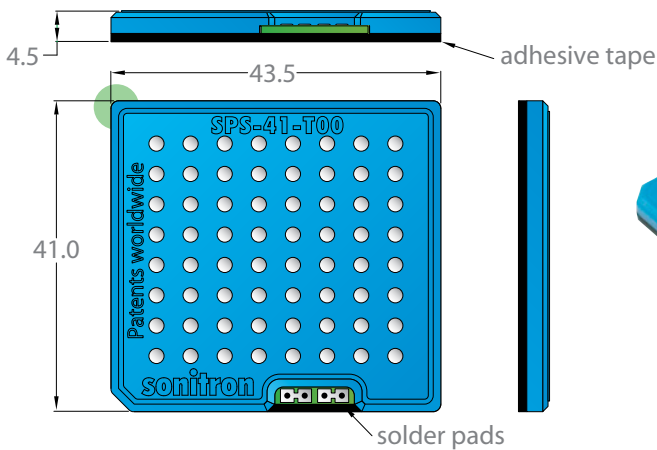

Scale:
1:1

SPS-53-T00

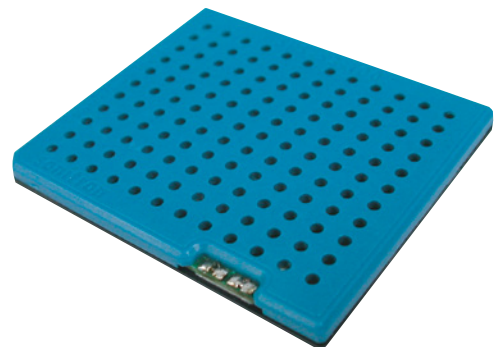
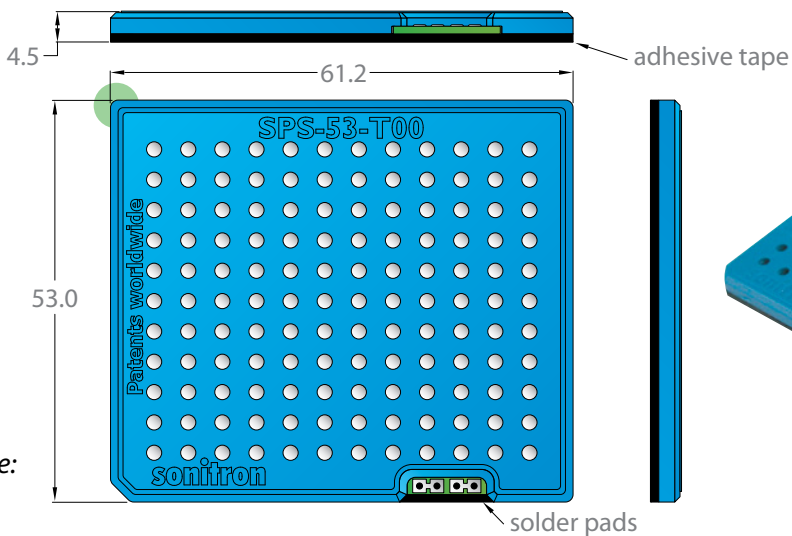

Scale:
1:1

DIMENSIONS

SPS-68-T00

Scale:
1:1

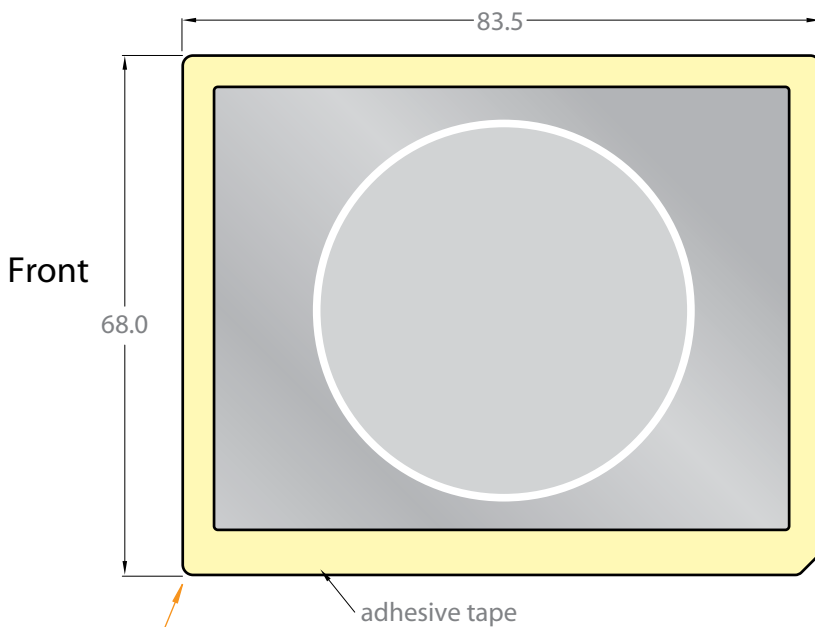
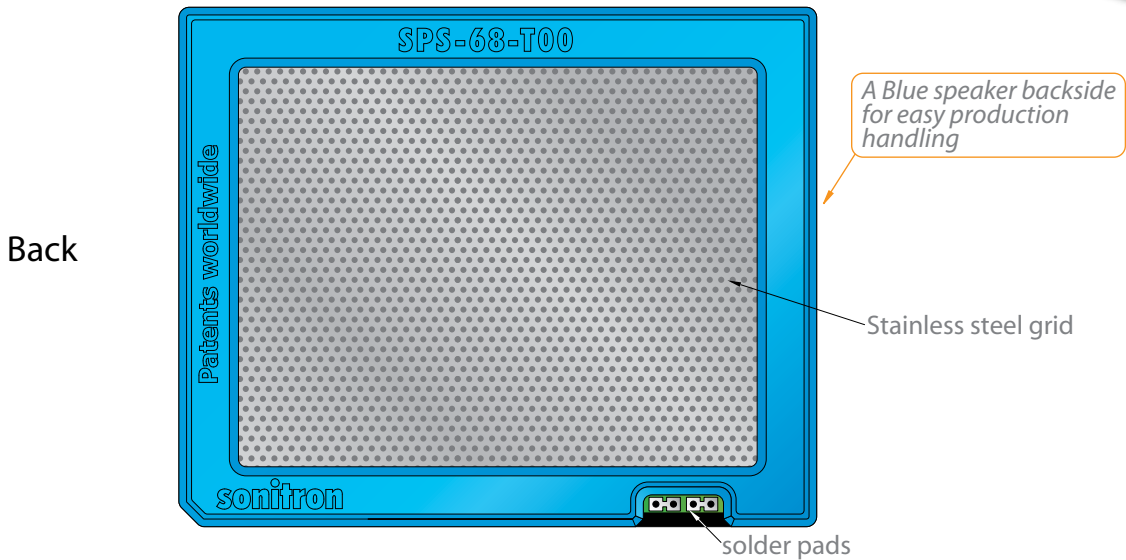

Inclusive adhesive tape for easy mounting into the application

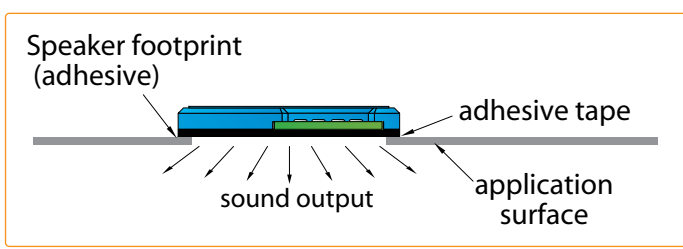

MOUNTING GUIDELINES

peel-off adhesive tape

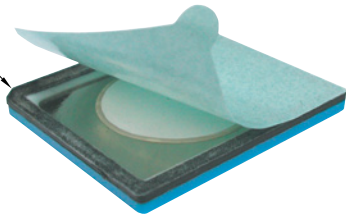

Speaker footprint (adhesive)

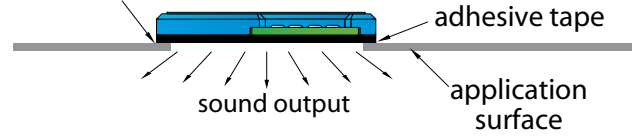

on request the speaker can be delivered without adhesive tape

Important: speaker grill cloth fabric, foam or other filters can be placed in front of the speaker to specifically "design" the desired sound output.

Speaker (adhesive) footprint

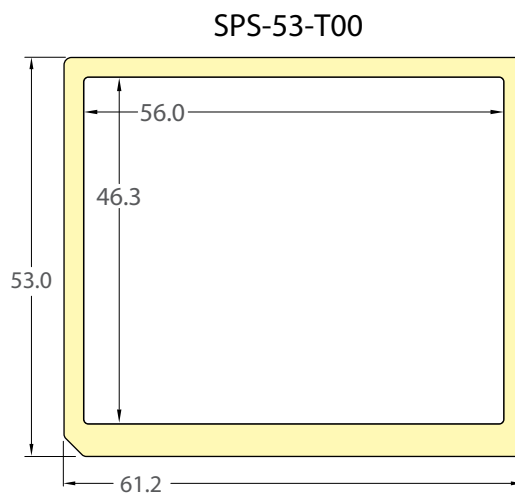
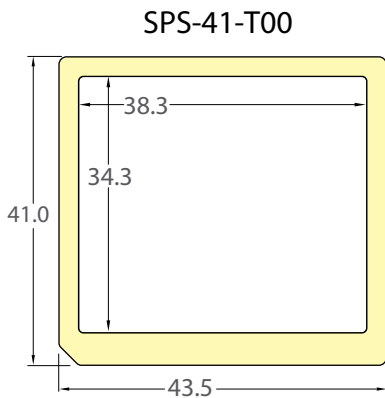
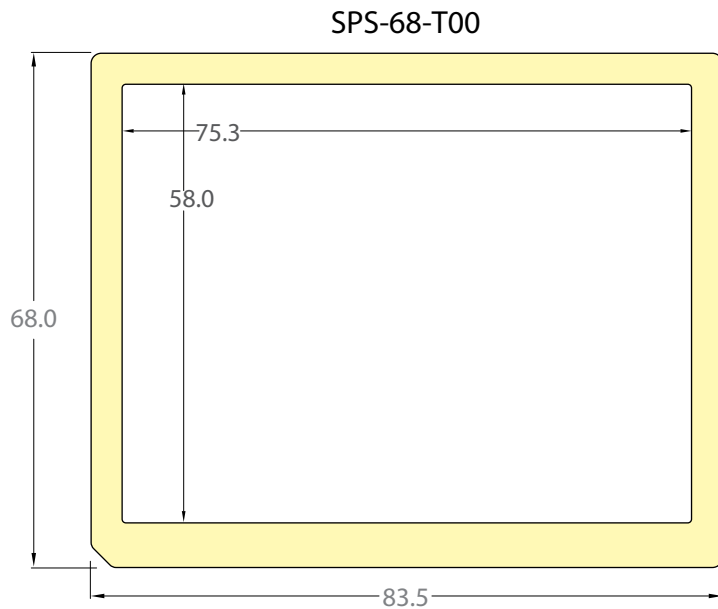
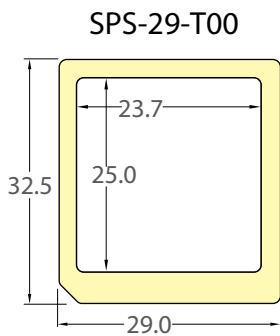

PRODUCT OPTIONS

Option FI (Front Installed) & FS (Front Seperate)

Optional a front panel is available, it is also equipped with adhesive tape for fast assembly to the application. It can be ordered pre-installed (already attached to the speaker) or as a separate part. (Be aware the speaker thickness increases with 1.5 mm.)

FI & FS option available for the following items:

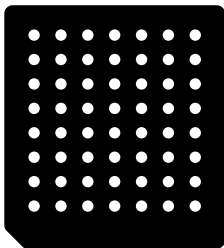

SPS-29-T00
FRONT PANEL

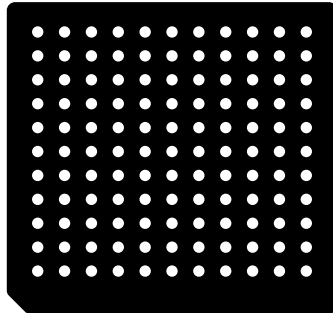

SPS-41-T00
FRONT PANEL

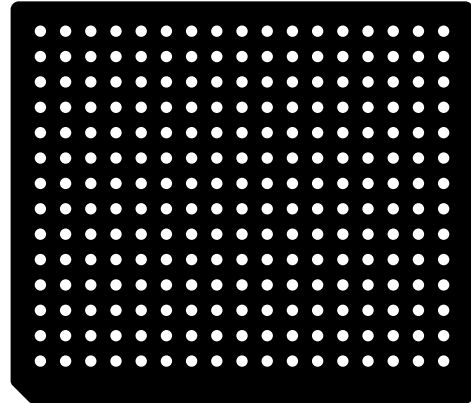

SPS-53-T00
FRONT PANEL

Construction example:

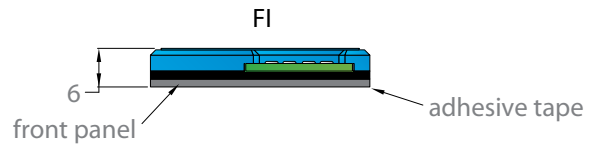
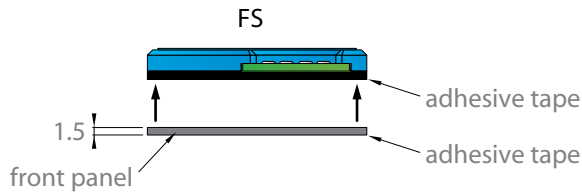

To order the speaker with pre-installed front panel add FI to the speaker codification (example: SPS-29-T00-**FI**)

To order the speaker with separate front panel add FS to the speaker codification (example: SPS-29-T00-**FS**)



PRODUCT CODIFICATION

SPS -	29 -	T	00 -	F I -	F S
↓	41	↓	↓	↓	↓
53	↓	↓	↓	↓	↓
68*	Size	Transducer	Version	Front Installed	Front Separate
Sonitron Polymer/metal Speaker					

*The SPS-68-T00 is always delivered without front. (standard with adhesive tape)

LIST OF AVAILABLE PRODUCT TYPES

Standard	Optional	Optional
SPS-29-T00	SPS-29-T00-FI	SPS-29-T00-FS
SPS-41-T00	SPS-41-T00-FI	SPS-41-T00-FS
SPS-53-T00	SPS-53-T00-FI	SPS-53-T00-FS
SPS-68-T00	Not available	Not available

PACKAGING

The SPS-29-T00/41-T00/53-T00/68-T00 are packed in trays (245 L x 245 W) and sold in boxes with dimensions of 250 L x 250 W x 125 H.

Model	SPS-29-T00	SPS-41-T00	SPS-53-T00	SPS-68-T00
per tray	30	16	9	6

Dimensions of the tray and position of the SPS-speakers SPS-29-T00/41-T00 and 53-T00 are illustrated below.

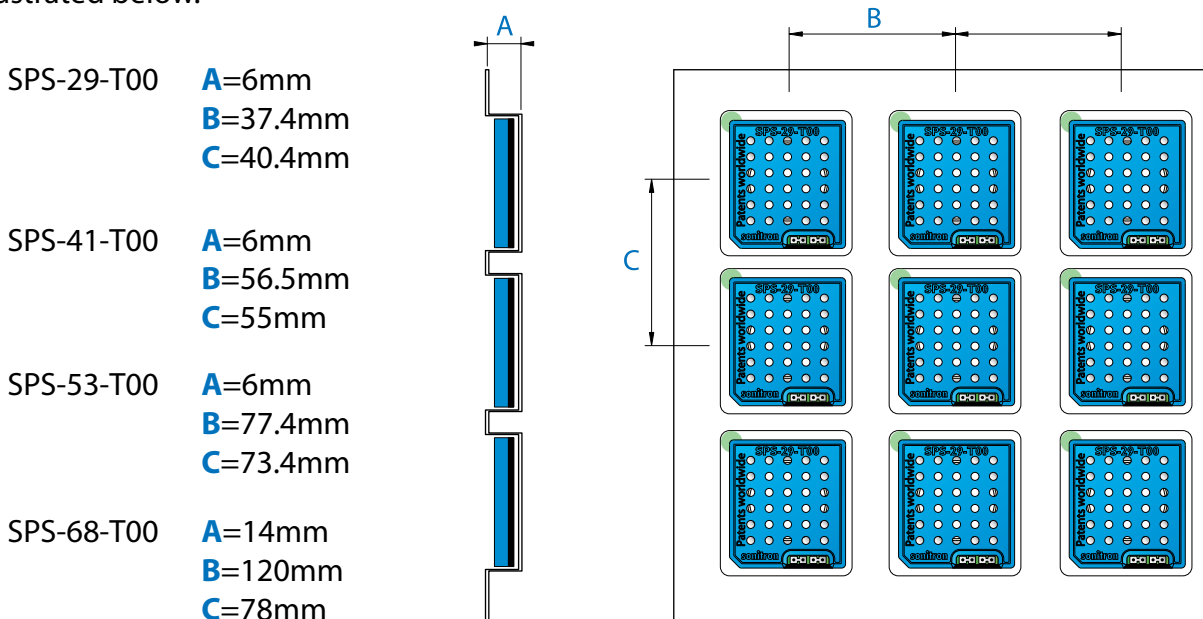

RECOMMENDED PIEZO AUDIO AMPLIFIERS

Integrated Circuits

Maxim
MAX9788

National semiconductor
LM4960

Texas Instruments
TPA2100P1

Sonitron production models

20Vpp amplifier

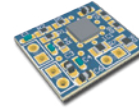

PAA-MAX-9788-01

24Vpp amplifier

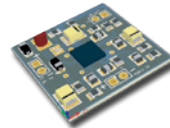

PAA-LM4960SQ-02

60Vpp amplifier

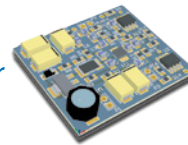

PAA-StepUpBTL-01

For more information about PAA-amplifiers, go to "PAA application documents" on our website.

AVAILABLE DEMO-UNIT AND SAMPLE-KIT



DU6597 & DU65SB

The demonstration unit DU6597 or DU65SB is the ideal way to have a first introduction to piezoceramic audio speaker technology.

PAA Sample kit

The PAA Sample kit gives you the freedom to do experiments with a piezoceramic audio speaker SPS-6555-03 and four different piezo audio amplifiers. The SPS-6555-03 piezo speaker is built-in a small case for optimum sound quality.

PAA amplifiers:

- PAA-LT3469-01
- PAA-MAX9788-01
- PAA-LM4960SQ-02
- PAA-StepUpBTL-01



PIEZO AUDIO AMPLIFIERS

PAA series

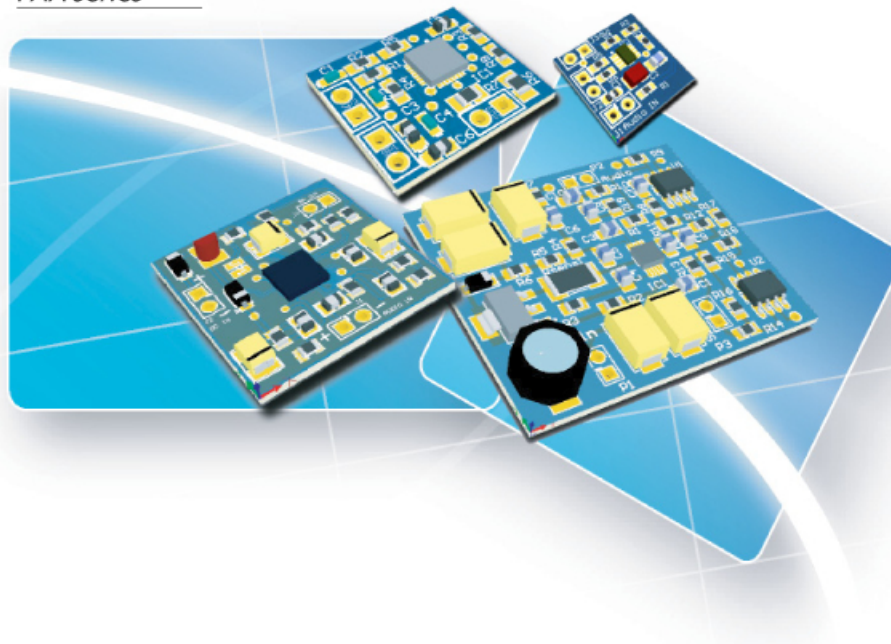

In parallel with the amplifiers developed at Sonitron we refer to various integrated circuits available on the market.

PIEZO AUDIO AMPLIFIERS

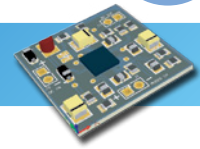

INTRODUCTION

The **P**iezo **A**udio **A**mplifiers-series are a total solution to drive piezoceramic sound components. A range of different PCB sizes, amplifier topologies and maximum voltage peak to peak outputs, cover a wide solution to piezo audio amplification.

Piezo audio amplifiers are designed to handle capacitive loads and have the possibility to deliver large voltages peak to peak over the complete audio frequency range.

The heart of a piezo audio component is a ceramic piezo stone that interacts when it feels a certain voltage difference. An increase of a voltage peak to peak will have a larger piezo deformation and results in a larger sound output.

The PAA-series give a quality amplifier solution where a quality sound is needed.

GENERAL OVERVIEW PAA SERIES

Model	PAA-LT3469-01	PAA-MAX9788-01	PAA-LM4960-02	PAA-StepUpBTL-01
Measurements PCB(mm)	15x15mm	14x16.5mm	25x25mm	40x35mm
Voltage input (V)	5V	5V	5V	5V-25V
MAX Capacitance Piezo Speaker	200nF	1µF	600nF	1µF
Max Voltage Output Vpp	33Vpp	20Vpp	24Vpp	60Vpp
Voltage Topology	Integrated step Up converter	Integrated step up converter	Integrated step up converter	Step up converter
Amplifier classification	Class A	Class G	Class AB	Class AB
Used amplifier configuration	Single ended	Fully Differential	Bridge Tied Load	Bridge Tied Load
Average current consumption of speaker and amplifier (mA)	45mA	15mA	85mA	40mA-400mA (2 Watt)

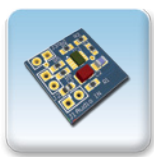

PAA-LT3469-01

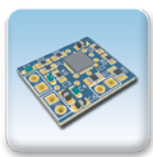

PAA-MAX9788-01

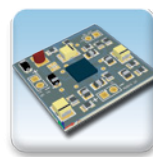

PAA-LM4960SQ-02

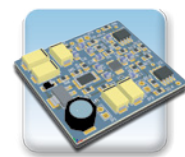

PAA-StepUpBTL-01

BASICS OF PIEZO AUDIO AMPLIFIERS

$$PAA = P_{\text{piezo}} A_{\text{audio}} A_{\text{amplifier}}$$

An amplifier for audio signals special designed to drive capacitive loads.

Max Cap.: The maximum capacitance the Piezo Audio amplifier can handle.

-*Load Capacitance:* The main impedance of the Piezo Speaker or Piezo vibration element is a capacitance with values mostly between 10nF and 1µF.

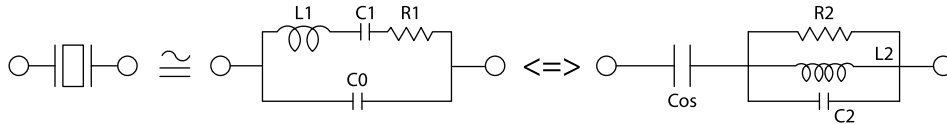

Simple Equivalent electronic circuits of a piezo element:

Max Vpp: Maximum voltage peak to peak that an amplifier can deliver at his output channel.

-*Max speaker Vpp:* Maximum voltage swing a piezo speaker can handle to work correctly within the described life time.

-*The heart of a Piezo speaker* is the piezo ceramic stone that interacts with voltage differences. How larger the voltage difference how more intense the amplitude of the sound will be.

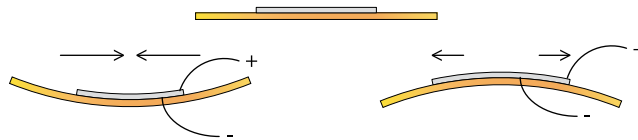

PIEZO AUDIO AMPLIFIER SERIES

PAA-LT3469-01

A PCB of only 2.25cm². The LT3469 is a very small signal amplifier up to 30Vpp.

- Integrated charge pump power supply
- Class A Amplifier
- Single ended
- Capacitive load up to 250nF
- 10 components

total thickness:
2.7 mm

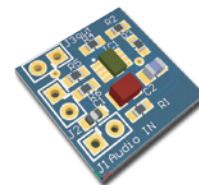
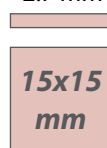

Fixed amplification ratio: +/- 131
Voltage input: 5 V

PAA-MAX9788-01

Designed on a printed circuits board of only 2,31 cm², the "Max9788" piezo audio amplifier of Maxim fulfils the needs of very small designs in portable applications. A maximum output of 20Vpp and very low power consumption makes it even more attractive.

- Integrated charge pump power supply
- Class G Amplifier
- Fully differential inputs and outputs
- Capacitive load up to 1µF
- 15 components

total thickness:
1.88 mm

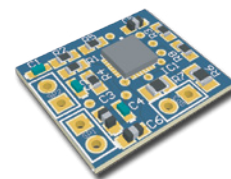
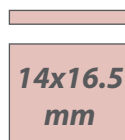

Fixed amplification ratio: +/- 80
Voltage input: 5 V

PAA-LM4960SQ-02

A perfect balance of a bridge tied load and step up converter on a small PCB, the "LM4960" IC of National Semiconductor reaches 24 Vpp for a load of 600nF. Small design and great sound output makes it very understandable.

- Integrated Step Up Converter
- Bridge tied load
- Very small inductor
- Up to 24Vpp
- 22 components

total thickness:
4.25 mm

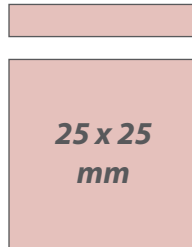

actual size

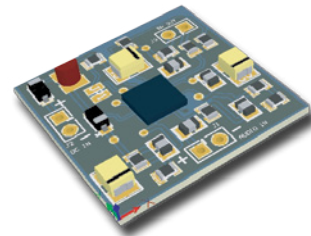

Fixed amplification ratio: +/- 74
Voltage input: 5 V

PAA-StepUpBTL-01

To go loud is to amplify the input signal to a large Voltage peak to peak swing of maximum 60Vpp. Tuned on the SPS piezo speakers the "StepUpBTL" piezo audio amplifier is designed for a very loud audio sound in a room.

The creation of a 60Vpp swing derives from a stable DC power source of 30 V DC.

The boostconverter circuit is designed to a minimum surface with a maximum variety at the input source. A variation of the input voltage between 5V and 25V gives at the end a stable 30VDC to power the opamps with efficient power consumption.

The amplifier circuit is a perfect balance between power consumption and space design. The Bridge Tied Load amplifier topology makes it possible to swing the signal to 60Vpp.

- Input voltage 5V-25V
- Max. output 60Vpp
- Two electronic circuits
- **Ideal: +input: 9Vdc**
+output: 40Vpp

total thickness:
6 mm

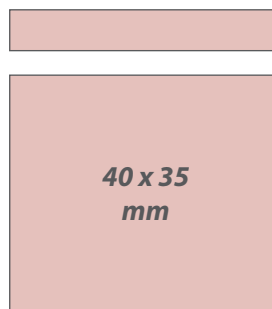

actual size

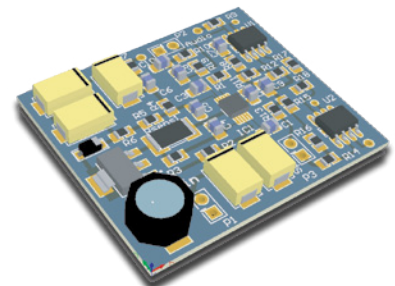

Fixed amplification ratio: +/- 90
Voltage input: 5-25 V

Boost converter + Amplifier

- DC-DC- converter: Max 669
=> output: 30 Vdc
- Amplifier circuit: OPA 551
=>"Bridge tied load configuration"

ADDITIONAL INFORMATION

DEMONSTRATION UNIT DU6597 & DU65SB

The DU6597 & DU65SB is a small speaker demonstration unit that consists of a piezoceramic speaker (SPS6555) and a piezo audio amplifier (PAA-MAX9788 or PAA-StepUpBTL-01).

The **SPS-6555-03** is a polymer/metal speaker with a very flat frequency response. The use of a piezoceramic disc as the heart of the speaker does not generate an electromagnetic field and ensures EMC requirements.

The **PAA-MAX9788** is a fully differential piezo audio amplifier with a class G topology. It is designed for applications where efficiency and small dimensions are a priority and can deliver a signal up to 20Vpp at 5V.

The **PAA-StepUpBTL-01** delivers 60Vpp audio output for loud applications.

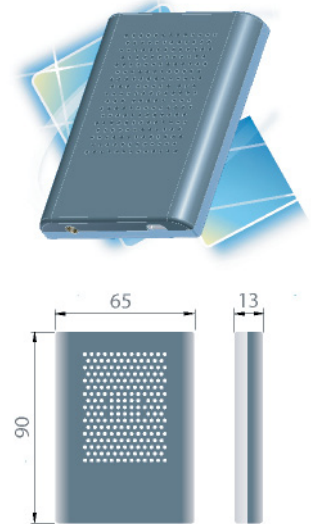

PRESENTATION EXAMPLES



Presentation with portable PC

The DU6597 & DU65SB is designed for use with MP3-players and the headphone output of a portable PC.

Please note: Other outputs or signals than the music headphone output can damage the

The power source comes from a USB power port and delivers 5V to the piezo audio amplifier. If no USB powerport is available an adapter can be used. In this case we recommend the iPod USB Power Adapter.



Presentation with MP3-player

PAA Sample kit

The PAA Sample kit gives you the freedom to do experiments with a piezoceramic audio speaker SPS-6555-03 and four different piezo audio amplifiers. The SPS-6555-03 piezo speaker is built-in a small case for optimum sound quality.

PAA amplifiers:

- PAA-LT3469-01
- PAA-MAX9788-01
- PAA-LM4960SQ-02
- PAA-StepUpBTL-01



Blind power dissipation in a piezoceramic load (for a sine wave)

The power dissipation in an electro-dynamic speaker depends on the resistance of the drive coil. In our comparison, the power dissipated in an electrodynamic speaker with \varnothing 68 mm and 16Ω impedance @ 2V is:

$$\frac{V^2}{R} = \frac{4}{16} = 0,25 \text{ W}$$

The power dissipation in a piezo capacitive load, not in resonance, is:

$$\frac{P}{2} = \frac{c.V^2.\omega.\cos\varphi}{2} + \frac{c.V^2.\omega.D_F}{2} = \frac{c.V^2.\omega}{2} . (\cos\varphi + D_F)$$

capacitive power
power dissipated in ceramic

D_F : Dissipation factor of the ceramic material

c : Capacitance of speaker

ω : $2\pi f$

V : Drive voltage

$\cos\varphi$: The phase angle between current consumption and voltage (in a capacitor is this angle 90° before in phase, thus $\cos\varphi = 0$)

In theory, the capacitive power is zero. The power dissipated in the ceramic disc of the speaker depends strongly on the dissipation factor of D_F of the used ceramic. The D_F is a measure of the dielectric losses in the material, defined as the tangent of the loss angle or the ratio of parallel resistance to parallel reactance, expressed in percent and measured at 1 kHz. This dissipation factor can vary from 0,4% up to 2% for the most typical ceramics available.

Our speakers are not used at resonance. Consequently the power dissipated mainly depends on the D_F and is very low or near zero.

The power dissipation of the piezo speaker can be considered as a blind power drain. The amplifier must deliver the total power needed to drive the circuit. Thus the total power drain of the piezo speaker is the drain of the amplifier, needed to deliver the blind power for the speaker, the power dissipated in the ceramics (due to the dissipation factor) and the power dissipated in the isolation resistor R_{ISO} .

THE IMPORTANCE OF THE ISOLATION RESISTOR (R_{ISO})

Amplifiers feeding capacitive loads can be stabilised in order to avoid oscillation at 180° degrees phase shift at certain feedback conditions.

There are many ways to stabilise an amplifier in combination with a capacitive load, but a small resistor R_{ISO} is very effective and easy to design-in. By adding an isolation resistor R_{ISO} in series with the amplifier output and the capacitive load of the speaker C_L , we improve the gain and phase margin over the entire frequency range.

By adding a R_{ISO} we create:

1. an extra F_{zero} (F_z) in the transfer function
2. we reduce the frequency of the pole with an output load in the transfer function

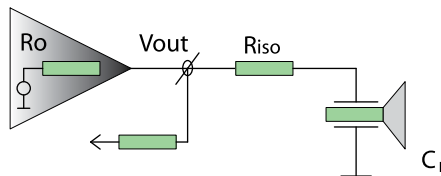

F_p : At this frequency, the poles are represented by -45 degrees phase shift with -45 degrees per decade slope, extending this line with 0 degree and -90 degrees horizontal lines.

$$F_p = \frac{1}{2\pi C_L (R_o + R_{ISO})}$$

F_z : At this frequency, the phase for zero is represented by a +45 degrees phase shift at the frequency of zero with +45 degrees per decade slope, extending this line with 0 degree and +90 degrees horizontal lines.

$$F_z = \frac{1}{2\pi C_L R_{ISO}}$$

The F_z in the transfer function is the product of R_{ISO} and C_L . The phase improvement is:

$$\Delta \theta : \tan^{-1} (2\pi \cdot UGBW \cdot R_{ISO} \cdot C_L)$$

- $\Delta \theta$ = improvement in phase margin
- UGBW = unity gain bandwidth frequency
- R_{ISO} = isolation resistor
- C_L = capacitive load of the speaker

APPLICATION NOTE

Automatic Speaker/Microphone switch + (pre)amplifier

Sonitron's piezoceramic speakers are ideal for use in multifunctional applications (speaker/microphone combination), because of the high sensitivity of the speaker membrane when used as microphone. They can be used in highly integrated equipment, such as GSM, PDA, portable games,... where voice commands could be an added value to meet customer's requirements. The principle starts from an audio detector, which senses if there's an audio input signal present or not. If not, the speaker is used as microphone. If yes, normal speaker operation is automatically selected.

Absolute Maximum Ratings

- Supply voltage : 20 VDC (applied via Wall Adapter input)
- Max. load capacitance: 800 nF
- Power Dissipation : Internally limited
- Audio Input Voltage : -0.3 V...Vcc + 5.3 V

Electrical Characteristics

- Supply Voltage : 7...20 VDC (wall adapter input, 12 VDC recommended)
- Speaker drive voltage: 24 Vpp
- Audio input signal : 600 mVpp typical
- Quiescent supply current : 20 mA (microphone), 70 mA (speaker)
- Total harmonic distortion: typical <1%

Microphone sensitivity of Sonitron's speakers

Model	SPS-2220-03	SPS-3530-03	SPS-4640-03	SPS-6555-03	SPS-8770-03
Sensitivity	6.8 mV/Pa	2.6 mV/Pa	2.8 mV/Pa	2.9 mV/Pa	3.01 mV/Pa

(Measured with a 1kHz/94dB signal)

SCHEMATICS

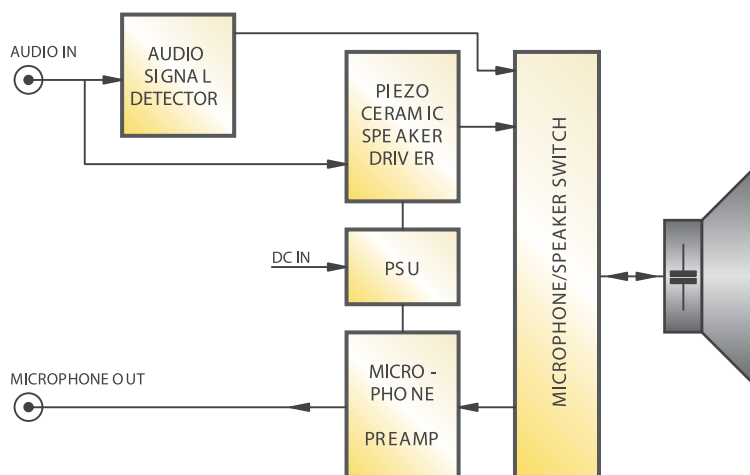

Automatic Speaker/Microphone switch + (pre)amplifier

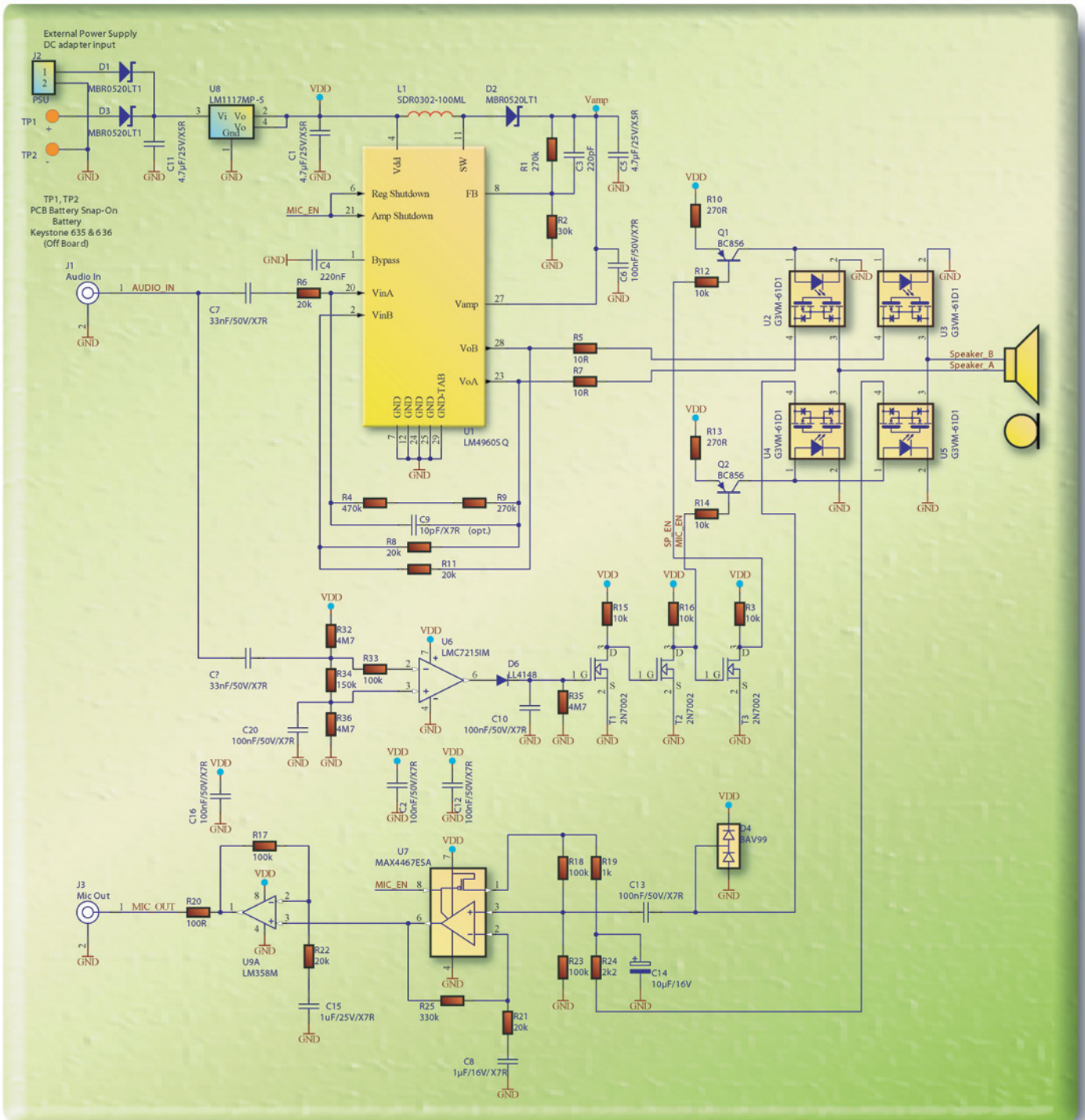

ADDENDUM



- Special product options*
- Considerations about sound*
- Harmonic*
- Fourier*
- Harmonic content of a square wave*
- RMS and average power*
- Expected life time*
- Soldering instructions*
- Critical components*
- Warranty and delivery conditions*
- IP ratings*
- Distributors & Representatives*

SPECIAL PRODUCT OPTIONS

Buzzers & Transducers

Standard Series (High quality buzzer)

Option Code	example	Description
W100	SCO715BL-W100	With 2 wires: length 10cm (instead of 2 pins)
W100	SCI535B5-W100	With 3 wires: length 10cm (instead of 3 pins)
W150	SCO715BL-W150	With 2 wires: length 15cm (instead of 2 pins)
W300	SCO715BL-W300	With 2 wires: length 30cm (instead of 2 pins)
ACR	SC235A-ACR	Acryl coating: The protective coating gives a complementary protection against smog. All standard series buzzers are perfectly waterproof (IP67) without the mentioned coating.
Gasket (O-ring)	GASKET	Rubber sealing ring for waterproof assembly. SP7 is inclusive O-ring. For 100% watertight assembly the O-ring together with loctite 5331 can be used.

SMA series (Quality Buzzer) / SMAT series (Quality Transducer) - Multi Application

Option Code	example	Description
SP01	SMAT-21-P10/SP01	Contains heavy duty wires (plastic insulation) (only for SMA(T)-21 and SMA(T)-24)
SP02	SMAT-21-P17.5/SP02	Contains heavy duty wires (plastic insulation), connection sealed with silicone (only for SMA(T)-21, SMA(T)-24)
SP04	SMA-13LC-S/SP04	The PCB of the buzzer/transducer is secured with epoxy-adhesive
SP05	SMA-24L-P17.5/SP05	Extended frequency control (only SMA series)
Wash Tab	SMAT-13-P7.5 +Wash Tab	Recommended for automatic washing production process. The PCB is secured with epoxy-adhesive+ wash tab upon the sound-emitting hole, avoiding liquid penetration into the cavity. TO BE REMOVED AFTER the washing process for good sound output!!!
MC	SMAT-13-P10-MC	Acryl coating (Membrane Coating). Recommended for aggressive, humid or smoggy environment.
FP13	SMAT-21-S-FP	Acoustic stabilization Foam Patch, easy to stick. For: SMA(T)-13-P7.5 SMA(T)-13-P10 SMA(T)-21S
FP17		Acoustic stabilization Foam Patch, easy to stick. For: SMA(T)-17-P7.5 SMA(T)-17-P10S SMA(T)-24-S
FP21		Acoustic stabilization Foam Patch, easy to stick. For: SMA(T)-21-P10 SMA(T)-21-P15 SMA(T)-21-P17,5 SMA(T)-30-S
FP24	SMA-24-P10-FP	Acoustic stabilization Foam Patch, easy to stick. For: SMA(T)-24-P10 SMA(T)-24-P15 SMA(T)-24-P17,5 SMA(T)-24-P20.32
FP30		Acoustic stabilization Foam Patch, easy to stick. For: SMA(T)-30-P10 SMA(T)-30-P15 SMA(T)-30-P17,5 SMA(T)-30-P20.32

SPECIAL PRODUCT OPTIONS

Buzzers & Transducers

FP13SR	Acoustic stabilization Foam Patch, easy to stick. For: SMA(T)-13-S
FP17SR	Acoustic stabilization Foam Patch, easy to stick. For: SMA(T)-17-S

SMB series (Multi Frequency Buzzer)

Option Code	example	Description
FP13	SMB-17CC-P10- FP	Acoustic stabilization Foam Patch, easy to stick. For: SMB-17CC-P10
FP24	MB-32CC-S- FP	Acoustic stabilization Foam Patch, easy to stick. For: SMB-32CC-P10 SMB-32CC-S

Alarms & Sirens

SAP series (Back-up Alarm) *No options available*

SAS series (Quality Siren)

Option Code	example	Description
MB1	SAS-2154-S-P grey- mb1	Mounting bracket MB1 for SAS series
MB2	SAS-2154-S-P grey- mb2	Mounting bracket MB2 for SAS series
MB3	SAS-2154-S-P grey- mb3	Mounting bracket MB3 for SAS series

SMAC series (High Quality Buzzer - High SPL)

Option Code	example	Description
MC	SMAC-25-P15- MC	Acryl coating: The protective coating gives a complementary assurance against smog. All Smac series buzzers are perfectly waterproof (IP67) without the mentioned coating.
Wash Tab	SMAC-25-P17.5 +Wash Tab	Recommended for automatic washing production process. The Wash Tab is upon the sound-emitting hole, avoiding liquid penetration into the cavity. TO BE REMOVED AFTER the washing process for good sound output!!!
FP21	SMACI-25-P15- FP	Acoustic stabillization Foam Patch, easy to stick. For: SMAC(I)-25-P15 SMAC(I)-25-P17.5

SXL series (High Quality Buzzer - High SPL)

Option Code	Description
W100	With 2 wires: length 10cm (instead of 2 pins)
W150	With 2 wires: length 15cm (instead of 2 pins)
W300	With 2 wires: length 30cm (instead of 2 pins)
ACR	Acryl coating: The protective coating gives a complementary protection against smog. All standard SXL series buzzers are perfectly waterproof (IP67) without the mentioned coating.
Gasket (O-ring)	Rubber sealing ring for waterproof assembly. SP7 is inclusive O-ring. For 100% watertight assembly the O-ring together with loctite 5331 can be used.

SPECIAL PRODUCT OPTIONS

Piezoceramic Speakers & Amplifiers

SCS series (Piezo Ceramic Speaker)

Option Code	example	Description
SP02	SCS-32-P10/SP02	Contains heavy duty wires (plastic insulation), connection sealed with silicone
FP17S	SCS-24-S-FP	Acoustic stabilization Foam Patch, easy to stick. For: SCS-24-P10 SCS-24-S
FP24S	SCS-32-S-FP	Acoustic stabilization Foam Patch, easy to stick. For: SCS-32-P10 SCS-32-S

HEAT PROTECTION LABEL AND WASH TAB (SMA series)

A heat protection label in capton material is glued on the SMD model of the SMA buzzer. This enables the user to pick up the buzzer by vacuum.

The heat shield remains on the buzzer during the reflow solder and must be removed after soldering. These heat protection labels are standard for each SMD buzzer automatically.

If a wash tab is ordered, the wash tab is glued on the buzzer to protect it from water penetrating into the hole of the cavity. The PCB at the back is also sealed with a silicon film. For ordering these parts, please add wash tab to the model number.

CLEANING

At 21°C the housing of our buzzers, transducers and speakers is not corroded or affected by oils, fuels, greases, most organic solvents or cleaning agents.



CONSIDERATIONS ABOUT SOUND

Loudness

The loudness of a sound perceived by the human ear at a certain location depends on several factors, such as: distance from the source, frequency of the sound, strength of the source, ear sensitivity, conditions of the air etc.

Sound pressure level versus distance

In a free progressive spherical sound wave the sound pressure drops by 6 dB each time the measuring distance is doubled. This condition only exists a number of wavelengths away from the source and if the source radiates spherical waves.

$$\Delta\text{SPL} = 20 \cdot \log(r1 / r2)$$

with: **r1 = distance at which the SPL is given**

r2 = distance at which you want to know the SPL

example: 105 dB(A) @2m =>@ 1m?
 => $\Delta\text{SPL} = 20 \log(2/1) = +6$
 => result: 111 dB(A) @ 1m

Weighting curve

The human ear is more sensitive to frequencies between 2000 and 5000 Hz. This is why the operating frequency of alerting piezo buzzers is essentially chosen for this range. The human ear has a logarithmically response to sound pressure, of which the unity is expressed in decibels (dB). The sound pressure level is measured with an audiometer; an instrument developed in order to give an objective indication to sound pressure. The frequency response of this instrument is corrected by a weighing curve to match the characteristics of the human ear. The type of the weighing curve is indicated by the symbol (A) that gives the indication dB(A).

A-weighting curve

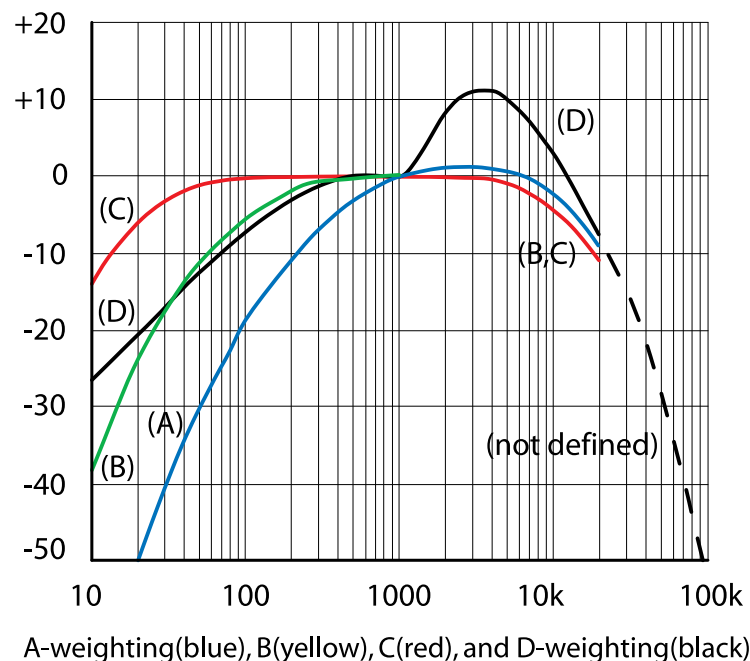

Pink noise

Pink noise or 1/f noise is a signal with a frequency spectrum such that the power spectral density is inversely proportional to the frequency. In pink noise, each octave carries an equal amount of noise power. There is equal energy in all octaves (or similar log bundles).

- In terms of power at a constant bandwidth, 1/f noise falls off at 3 dB per octave.
- Pink noise has a tendency to occur in natural physical systems.
- White noise is equal energy per hertz.

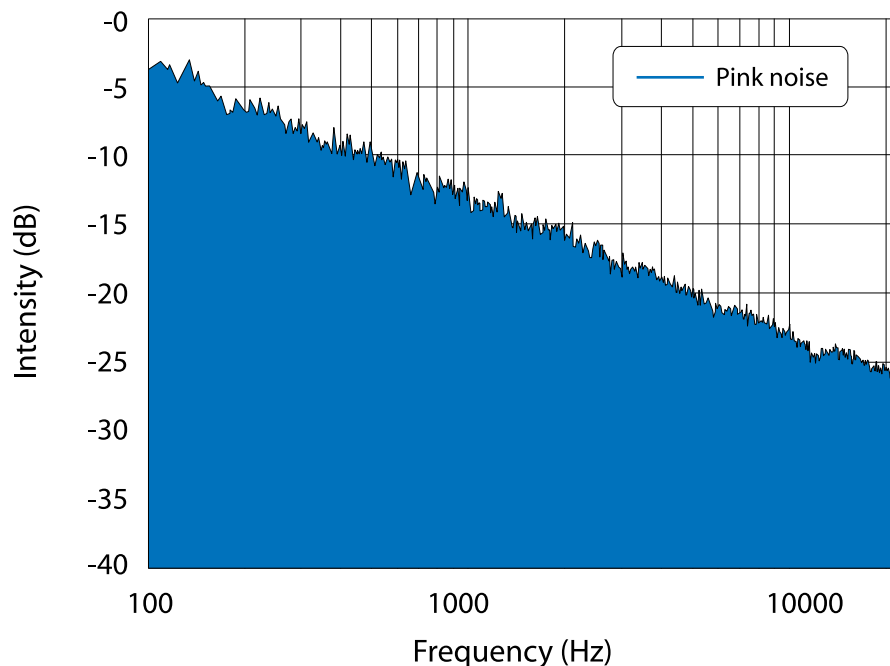

Sound character

The character of a sound is determined by the harmonic content, the amplitude relation between the harmonics for a steady signal when the signal varies the rate of attack and decay, and the presence of resonance.

Pulsating sounds

The human ear is particularly sensitive to changes in condition. Switching on and off a sound makes it more attention-getting than a continuous sound of the same frequency. Shifting the frequency in a rapid rate produces a similar effect.

Pulsating frequency

When a pulsed sound source is placed in a reverberant room, reflections tend to fill up the pauses between the pulses. In a large, highly reverberant room, longer pauses are necessary to produce the desired effect: a slow pulsing sound source should be used.

HARMONIC

In acoustics a harmonic of a wave is a component frequency of the signal that is an integer multiple of the fundamental frequency.

n = 1	n = 2	n = 3	n = 4	...
f1	f2	f3	f4	...
300Hz	600Hz	900Hz	1200Hz	...

FOURIER

To analyse a certain sound or function it can be decomposed in basic pieces. Mathematical a Fourier series can be used to decompose a periodic function or signal into a sum of simple oscillating functions, namely sines and cosines.

The use of a fourier analyse of a signal into sine waves with a certain amplitude gives the opportunity to study the amplification response of different vibrating systems.

Overview of basic mathematical signals and the corresponding fourier series:

Signal	Time domain	Fourier domain	Frequency domain (log scale)
sine wave		$f_{1_sine} = \frac{V_{pp}}{2} \cdot f_{1sin}$ $\sin(\omega_0 t)$	
triangle wave		$f_{1_triangle} = \frac{V_{pp}}{2} \cdot \frac{8}{\pi^2} \cdot \left(\frac{1}{1^2} f_{1sin} + \overset{\pi \text{ phase change}}{(-)} \frac{1}{3^2} f_{3sin} + \frac{1}{5^2} f_{5sin} + \overset{\pi \text{ phase change}}{(-)} \frac{1}{7^2} f_{7sin} + \dots \right)$ $\sum_{n=1, n=odd}^N \left(\frac{1}{n^2} \right) \cdot \sin(n\omega_0 t)$	
square wave		$f_{1_square} = \frac{V_{pp}}{2} \cdot \frac{4}{\pi} \cdot \left(f_{1sin} + \frac{1}{3} f_{3sin} + \frac{1}{5} f_{5sin} + \frac{1}{7} f_{7sin} + \dots \right)$ $\sum_{n=1, n=odd}^N \left(\frac{1}{n} \right) \cdot \sin(n\omega_0 t)$	

- f1: ground frequency (first harmonic) Vpp= voltage peak to peak
- f2: second harmonic
- f3: thirth harmonic
- fn: "n" th harmonic

HARMONIC CONTENT OF A SQUARE WAVE

If a square wave is analysed with his fourier series into a sum of sine waves it is notable that it contains a lot of harmonics with a high amplitude.

Or otherwise, a pure square wave can be build as the sum of many $f(2n-1)$ odd harmonics.

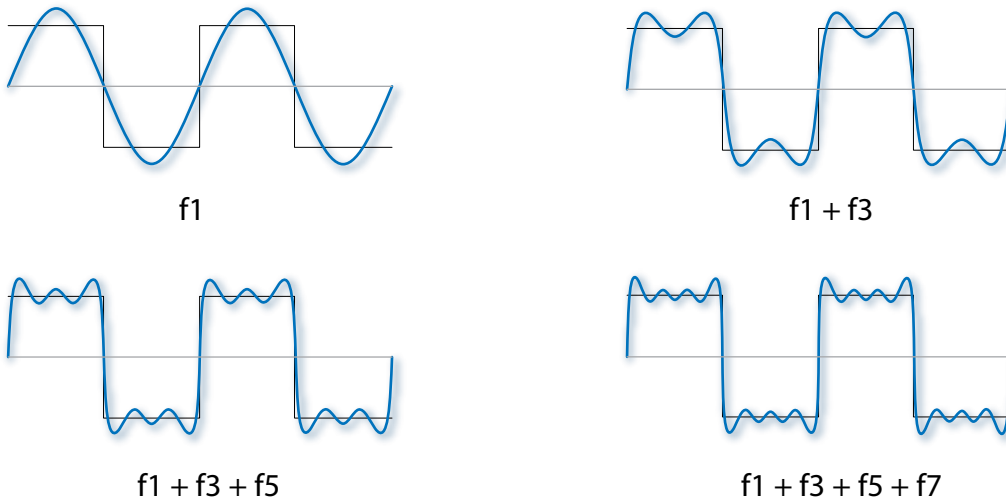

RMS AND AVERAGE POWER

The average power gives an idea of the power consumption of a device over a certain time period. It can be easily found by multiplying the RMS-voltage and RMS-current .

$$P_{average} = V_{RMS} \cdot I_{RMS}$$

RMS is a mathematical function that reduces a complex function to a single value. It is the "square Root of the Mean of the Square of the function". Mean is the same as average.

$$x_{rms} = \sqrt{\frac{1}{n} \sum_{i=1}^n x_i^2} = \sqrt{\frac{x_1^2 + x_2^2 + \dots + x_n^2}{n}}$$

EXPECTED LIFE TIME

The lifetime of our audible components depends on many different factors and is impossible to determine exactly. We therefore publish the expected minimum lifetime measured under specific circumstances and environmental conditions.

If customers need lifetime expectations under other circumstances, we request them to ask for our instructions before performing their own lifetime tests in order to save time and exclude wrong conclusions.

Claims will only be examined and taken into account on condition that guidelines and instructions below have been strictly applied.

Working voltage or drive signal versus expected life time:

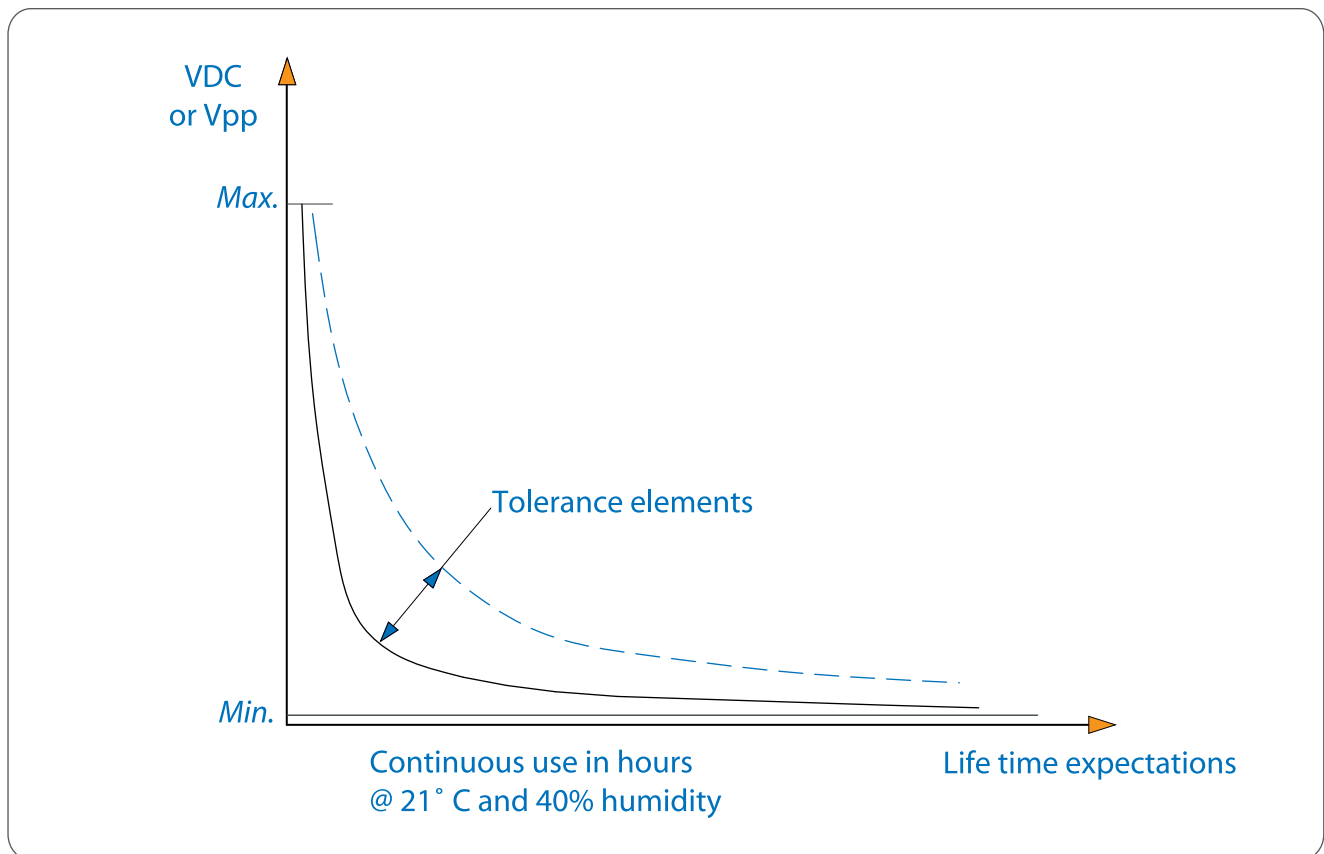

The relationship between working voltage and expected life time is one of the prime factors on which life time depends. The curve follows an asymptotic function, strongly depending on tolerance elements published by the suppliers of several basic materials and working environmental conditions.

The expected life time of our different series is defined as follows:

- **T ambient: 21 °C; humidity: 40%; free air**
- **Voltage : see below**
- **Mounted as described in our catalogue**

Standard series:

- mounted on panel
- working @ 12 Vdc in continuous use
- life expectations: min. 2000 hours
- The SXLC515C, SXLI515C1, SXLW515C and SXLP515C series have a minimum life time of 9 hours

SMA series:

- mounted on PCB
- working @ 12 Vdc in continuous use; L-version working @ 6 Vdc
- life expectations: min. 100 hours
- The SMA-21LV (PIN/SMD) working @ 3 Vdc in continuous use: min. 24 hours
- All tests are made @ 20°C

SMAT series

- mounted on PCB
- working @12 Vpp in continuous use at resonance frequency, tested on maximum sound pressure (eg. SMAT-21 @ 3.75 kHz).
- life expectations: min. 1000 hours

SMAC series

- mounted on PCB
- working @12 Vdc in continuous use.
- life expectations: min. 1000 hours

Remarks:

- Please contact our customer service for information and our recommendations before making life time tests at voltages exceeding the above-mentioned levels per series.
- Sonitron reserve the right to make modifications without pre-announcement to their materials, raw materials, specifications, configurations and prices.
- Applications in this catalogue are indicative and it is the responsibility of the customer to make the necessary tests with our products in order to meet the required specifications.
- If you need further information concerning product selection, performances, life time expectations and environmental situations, please contact us.
- The use of Sonitron products, as critical components in life support systems, is not authorised without the explicit written approval by Sonitron.
- If our Products are used as a critical component (final alarms in life support system), we recommend a model especially adapted to the customers' special test requirements.

SOLDERING INSTRUCTIONS

WARNING !!!

IMPORTANT REMARK:

Our products are heat sensitive products. By overheating the air inside the buzzer, silver migration can occur and solder points can be destroyed.

Depolarisation of the membrane might occur if the internal buzzer temperature exceeds 210 °C. To avoid damage to our products, the following instructions and recommendations for maximum time and temperature must be respected during soldering:

Wave Soldering.

Typical settings:

Preheat temperature: 100 °C

Solder bath temperature 250 (lead)/265 °C (lead-free alloy).

Wave soldering cycle time: 4 sec. (single wave), 6 sec. (dual wave).

Typical settings: Figure 1.

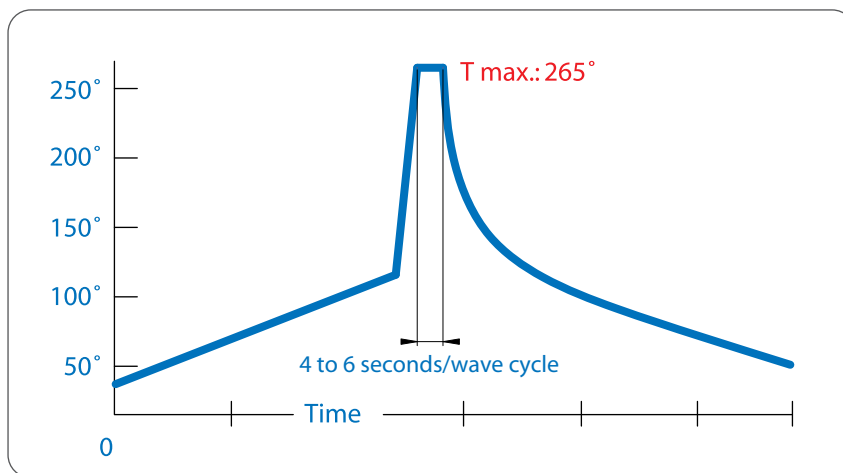

Figure 1.

Vapor Phase Soldering

Sonitron products are not suitable to be used in a vapour phase soldering process

Manual Soldering (soldering by hand)

Typical equipment settings:

-270/350 °C (lead(pb) alloys, e.g. Sn60Pb40). 50w Soldering Iron.

-285/380 °C (Lead-free alloys) e.g., SAC305, or 96SC). 80w Soldering Iron.

Note: Temperatures may vary depending on the equipment used.

Reflow Soldering.

Sonitron SMD buzzers can be used in a Low Temperature surface mount soldering environment with peak reflow soldering conditions below 210°C.

A typical reflow soldering profile is displayed in figure A1.

Note: Settings may vary depending on machine type and materials used.

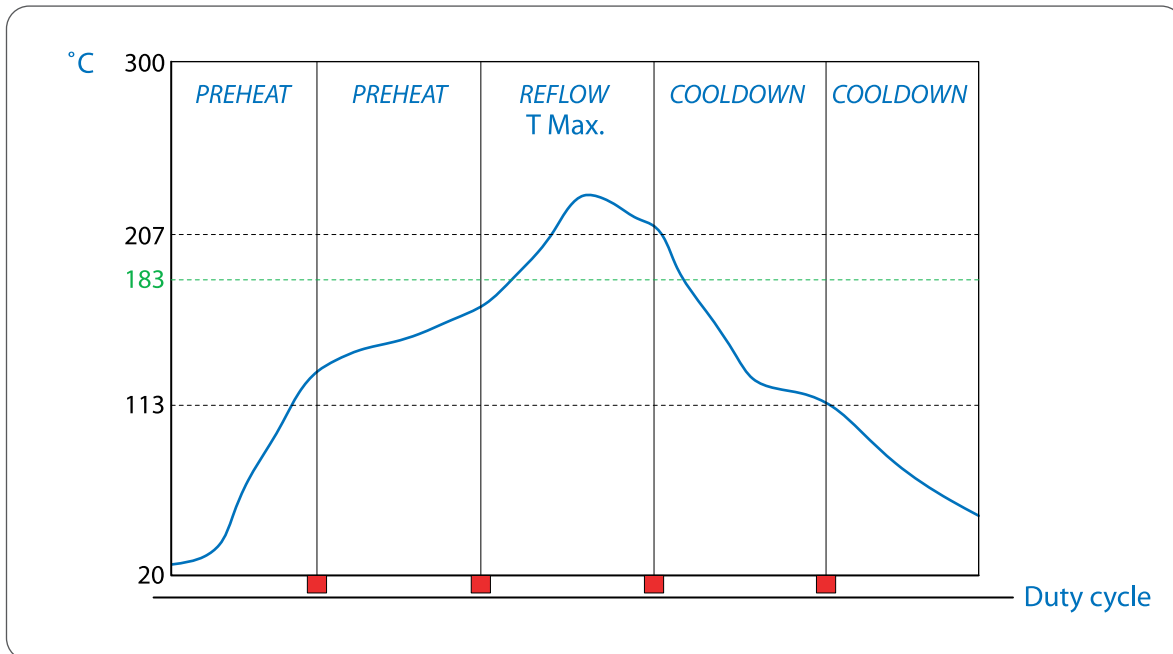

Figure A1

Infrared soldering method:

Maximum temperature of 175°C during 4 minutes or maximum temperature of **210°C during 30 seconds** may not be exceeded.

Remark:

1. All our speaker models can be provided with through hole terminals or flat SMD terminals. The SMD models cannot be soldered in a lead-free soldering process. These components must be soldered manually.
2. Buzzers with through hole terminals can only withstand high temperatures (up to 200 °C environmental temperature) when provided with a heat resistant PPS housing. This has to be explicitly mentioned on the order form.

Lead free solder types:

Wave Soldering: Typical: SAC305 alloy, SN100C

Reflow Soldering: Typical : Alpha CVP-520 (Low Melting Point No-Clean solder paste),
or equivalent

Manual Soldering: Most standard lead-free solder wires are suitable.

Terminal material:

Tinned brass for both pin terminals and SMD terminals.

Recommended solder, and solderpaste suppliers:

Agmet Ltd/ESL-Europe U.K
www.electroscience.com

Balver Zinn Josef Jost GmbH
Germany
www.balverzinn.com

Indium Corporation of Europe
U.K.
www.indium.com

Cobar Europe.
www.cobar.com

Cookson Electronics
www.cookson.be

Kester lead-free
www.kester.com

Felder lottechnik
www.felder.de

Henkel Technologies
www.loctite-europe.com

Koki company Ltd
www.ko-ki.co.jp

Useful links:

www.leadfree.org

CRITICAL COMPONENTS AND RMA WARRANTY

CRITICAL COMPONENTS (important note)

We consider critical components these having a final acoustic warning signal in dangerous applications such as: life support systems and equipment used to warn for life danger such as: portable gas detectors, medical monitoring equipment, aircraft cockpit alarm's, car breaking alarm's etc...

Components used as an acoustical function in order to indicate continuous supervision of a control function being an audible warning of immediate danger of changes in situations or conditions of environment as life danger or critical function.

In all above described functions, applications and use we recommend our Standard-series and Smac-series. All other models or series can only be used after written approval of the Sonitron application support department or management with test recommendations after receipt of the described application in detail by the customer.

WARRANTY AND DELIVERY CONDITIONS

Our products are warranted during one year after date of shipment.
(Warranty void if product is opened.)

In case products are returned for quality control, the products must be sent to the factory with the following information :

- Samples of the defective pieces
- Name and address of the customer
- Application description
- Invoice-number
- Copy of the inspection sheet delivered in the box
- Copy of the written complaint from the customer

This should be accompanied by our QD1 document, which will be send to you immediately after registration of your complaint. This document should be duly completed, so that we have sufficient details about the problem in order to deal with the matter swiftly.

The products must be used according to the working instructions and conditions specified in our technical data. Return shipments will only be accepted for quality control, if the products have not been physically changed, damaged or opened. They will only be accepted if all the required information is available.

Customers doing life tests or functional condition tests on Sonitron parts are requested not to use the tested parts for further use in their application.

These parts have been put under exceptional stress and other critical environmental conditions aging the tested products before normal use.

Normal lifetime cannot be applied anymore on these parts.

Returned products with request by the customer for quality replacement (RMA), but which are found to be destructed due to exceptional life and/or stress tests, will not be replaced.

Sonitron reserves the right to invoice the costs, made for investigation of the abusive quality claims, to the customer.

IP-RATINGS

The IP rating system provides a means of classifying the degrees of protection from dust, water and impact for electrical equipment and enclosures. The system is recognised in most European countries.

The degrees of protection are most commonly expressed as 'IP' followed by two numbers, where the numbers define the degree of protection. The first digit indicates the extent to which the equipment is protected against particles, or to which persons are protected from enclosed hazards. The second digit indicates the extent of protection against water.

DIGIT	FIRST NUMBER- SOLID	SECOND NUMBER- LIQUID
0	Not protected	Not protected
1	Protected against solid objects over 50mm, e.g. Accidental touch by hand	Protected against vertically falling drops of water
2	Protected against solid objects over 12mm diameter, not exceeding 80mm long, e.g. fingers	Protected against direct sprays of water up to 15° from the vertical
3	Protected against solid objects over 2.5mm, e.g. tools and wires	Protected against sprayed water up to 60° from the vertical
4	Protects against solid objects over 1.0mm, e.g. small wires	Protected when sprayed from any direction - limited ingress allowed
5	Protected against dust, limited ingress (no harmful deposit)	Protected against low pressure jets, from all directions - limited ingress allowed
6	Dust tight. Totally protected against dust	Protected against strong jets of water with limited ingress allowed
7	n/a	Protected against temporary immersion between 15cm and 1m for up to 30 minutes
8	n/a	Protected against long periods of immersion under pressure



sonitron® n.v.
Kasteelstraat 93
9100 Sint-Niklaas
BELGIUM
Tel.: 32 3 780 76 30
Fax.: 32 3 777 58 96
sales@sonitron.be
info@sonitron.be
<http://www.sonitron.be>
<http://www.sonitron.eu>

