

# **HYPERGRIP®** **CONNECTOR SERIES**

*High Reliability Medical Connectors*



# HYPERBOLOID TECHNOLOGY

Smiths Connectors offers an extensive range of superior contact technologies suitable for standard and custom solutions. Hypertac® (HYPERboloid conTACT) is the original superior performing hyperboloid contact technology designed for use in all applications and in harsh and demanding environments where high reliability and safety are critical. The inherent electrical and mechanical characteristics of the Hypertac hyperboloid contact ensures unrivalled performance in terms of reliability, number of mating cycles, low contact force and minimal contact resistance. The shape of the contact sleeve is formed by hyperbolically arranged contact wires, which align themselves elastically as contact lines around the pin, providing a number of linear contact paths.

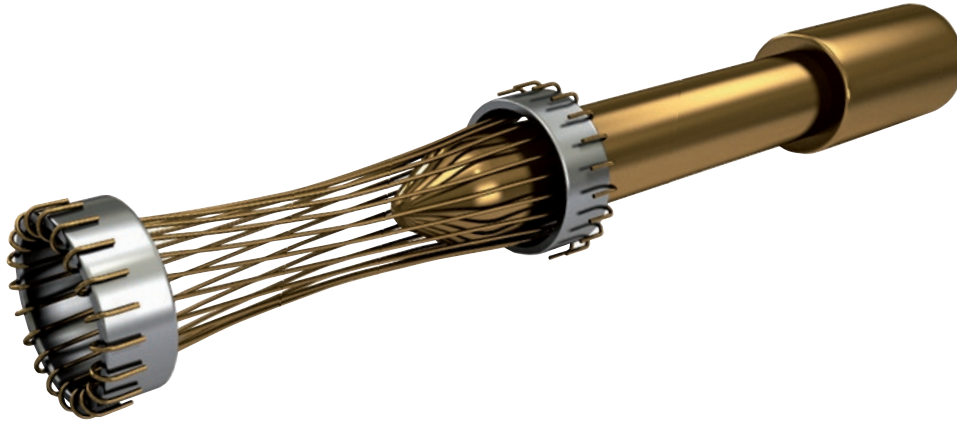

## FEATURES

### LOW INSERTION/EXTRACTION FORCES

The angle of the socket wires allows tight control of the pin insertion and extraction forces. The spring wires are smoothly deflected to make line contact with the pin.

### LONG CONTACT LIFE

The smooth and light wiping action minimizes wear on the contact surfaces. Contacts perform up to 100,000 insertion/extraction cycles with little degradation in performance.

### LOWER CONTACT RESISTANCE

The design provides a far greater contact area and the wiping action of the wires insures a clean and polished contact surface. Our contact technology has half the resistance of conventional contact designs.

### HIGHER CURRENT RATINGS

The design parameters of the contact (e.g., the number, diameter and angle of the wires) may be modified for any requirement. The number of wires can be increased so the contact area is distributed over a larger surface. Thus, the high current carried by each wire because of its intimate line contact, can be multiplied many times.

### IMMUNITY TO SHOCK & VIBRATION

The low mass and resultant low inertia of the wires enable them to follow the most abrupt or extreme excursions of the pin without loss of contact. The contact area extends 360 degrees around the pin and is uniform over its entire length. The 3 dimensional symmetry of the Hypertac contact design guarantees electrical continuity in all circumstances.

## BENEFITS

### HIGH DENSITY INTERCONNECT SYSTEMS

Significant reductions in size and weight of sub-system designs. No additional hardware is required to overcome mating and un-mating forces.

### LOW COST OF OWNERSHIP

The Hypertac contact technology will surpass most product requirements, thus eliminating the burden and cost of having to replace the connector or the entire subsystem.

### LOW POWER CONSUMPTION

The lower contact resistance of our technology results in a lower voltage drop across the connector reducing the power consumption and heat generation within the system.

### MAXIMUM CONTACT PERFORMANCE

The lower contact resistance of the Hypertac contact reduces heat build-up; therefore Hypertac contacts are able to handle far greater current in smaller contact assemblies without the detrimental effects of high temperature.

### RELIABILITY UNDER HARSH ENVIRONMENTS

Harsh environmental conditions require connectors that will sustain their electrical integrity even under the most demanding conditions such as shock and vibration. The Hypertac contact provides unmatched stability in demanding environments when failure is not an option.

# TABLE OF CONTENTS

**HYPERGRIP® SERIES ..... 2**

- ▶ Hyperboloid Technology ..... 2
- ▶ HyperGrip® Features & Benefits ..... 4
- ▶ Technical Characteristics ..... 5
- ▶ Dimensions:
  - Standard Plug & Receptacle (HG0, HG2, HG3, HG4) ..... 6
  - Plug & Cable Receptacle (HG2) ..... 7
- ▶ Keying & Mounting:
  - Receptacle Keying ..... 8
  - Panel Cutouts ..... 8
  - Receptacle Mounting Options ..... 9
- ▶ Markets & Applications ..... 10
- ▶ How to Order ..... 11
- ▶ Available Contact Technologies ..... 12
- ▶ Contact Arrangements ..... 13
- ▶ Smiths Connectors Product Lines ..... 14



## FEATURES

- ▶ Push/Pull latching feature
- ▶ Innovative customer keyability
- ▶ Available in 5 color options
- ▶ Sleek, robust body
- ▶ Sealing to IP67 when mated
- ▶ Fingerproof
- ▶ Multiple contact technologies available
- ▶ Shielding option available in HG2, HG3 and HG4
- ▶ Autoclave, EtO, Gamma and Sterrad®\* sterilizable
- ▶ UL94 V-0 flammability rated materials
- ▶ Integrated strain relief
- ▶ Contacts shipped unloaded

## BENEFITS

- ▶ Quick connect - simple one-hand mating/unmating
- ▶ Easily keyed in 6 standard positions to prevent mismatching
- ▶ Visually intuitive mating
- ▶ Designed to aesthetically complement medical devices
- ▶ Meets or exceeds typical medical sealing requirements
- ▶ Meets requirements of IEC 60601-1 specifications
- ▶ Flexibility for superior performance in high reliability, high speed, high density, high frequency and/or hybrid solutions
- ▶ Protection against EMI/RFI interference
- ▶ Meets typical medical sterilization requirements
- ▶ Meets medical industry safety requirements
- ▶ Prevents cable wire fatigue due to bending
- ▶ Easier termination for reduced cost of ownership: crimp and poke termination eliminates the need to pre-tin, solder or shrink boot

# HYPERGRIP® SERIES

HyperGrip Circular Connector Series is available with 5, 12, 19, or 33 pin positions and a user-configurable keying system. While competitive products require purchasing a different connector for each keying configuration needed, our advanced keying system allows customers to build connectors with six different keying options reducing lead time and inventory.

Specifically designed to meet medical industry requirements, the HyperGrip connector's sleek, robust body delivers superior performance in the most crucial applications. Not only does the standard sealing offer IP67 protection when mated to prevent electrical shorts, but the available shielding feature supplies EMI/RFI protection providing the highest degree of safety and reliability.

By utilizing the unparalleled performance of Hypertac® hyperboloid contact technology, HyperGrip connectors are able to provide high cycle life, low power consumption, low insertion force, reliability under harsh conditions, maximum contact performance and excellent wiping action.

HyperGrip connectors are color-coded and range from 1/2 to 2 inches in diameter. The five available color options, along with our innovative keying system, make recognition effortless and incorrect mating impossible. This becomes essential for medical instrumentation applications where multiple connector interfaces are required.

Smiths Connectors offers custom options in order to meet application specific requirements. The flexible design of HyperGrip connectors allows for the use of alternate technologies including Fiber Optic (expanded beam or butt joint termini), Coaxial and Spring Probe contacts. Custom inserts, cable mount receptacles and cable assemblies (available in select sizes) can also be provided to optimize your connector solution.



# TECHNICAL CHARACTERISTICS

	HG0	HG2	HG3	HG4
Number of Contacts	5	12	19	33
Contact Diameter	0.012 [0.30]	0.016 [0.40]		

## MATERIALS

Body	Polyetherimide
Insulators	Liquid crystal polymer
Sealing	Silicone

## CONTACT MATERIALS & PLATING

Sockets	Beryllium copper wires Brass body components Gold over nickel plating on mating surface Gold flash over nickel on termination
Pins	Phosphor bronze Gold flash over nickel plated

## TERMINATIONS

Crimp (Pin & Socket)	26 to 28 AWG
----------------------	--------------

Optional terminations, including solder cup and straight-dip pc tails (for panel mount receptacles), are special order only. Please contact factory for availability.

## SHIELDING (optional)

Effectiveness	Up to 3 GHz
Attenuation	50 dB maximum at 3 GHz

## MECHANICAL

Mating Cycle Life	Up to 20,000
Contact Extraction Force	0.50 to 1.60 oz. per contact

## ELECTRICAL

Current Rating	1.0 A
Contact Resistance	< 8.0 mΩ
Breakdown Voltage Between Contacts	1,000 V max.
Dielectric Withstanding Voltage	750 V
Insulation Resistance	> 5 x 10 <sup>4</sup> MΩ at 500 VDC

## PHYSICAL AND ENVIRONMENTAL

Operating Temperature Rating	-40° to 125° C
Processing Temperature Range	Up to 185° C
Flammability	UL94 V-0 rated
Sterilization	Steam Autoclave, Gamma, EtO, Sterrad®*
Fingerproofing	Meets IEC 60601-1 requirements
Sealing	IP67 (for temporary submergence)

### Notes:

1) HyperGrip is patented under US patent numbers: 7,326,091B2; 7,661,995B2; D596,127S; 7,938,670; D615,932; D616,825  
Dimensions are in inches [mm]

# DIMENSIONS

## Standard HyperGrip® Connectors

### ▶ STANDARD PLUG & RECEPTACLE

For HG0, HG2, HG3 and HG4

**PLUG & RECEPTACLE MATED PAIR**  
with strain relief

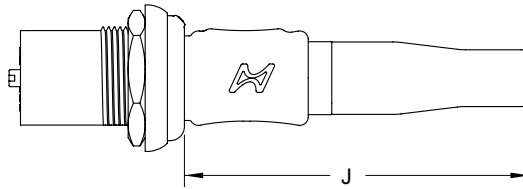

**[E] RECEPTACLE**

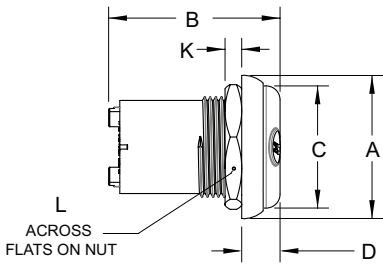

**[E] RECEPTACLE**  
with shielding option

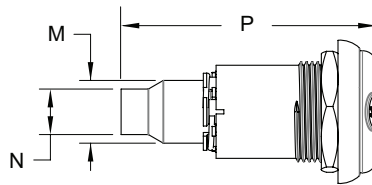

**[P] PLUG**

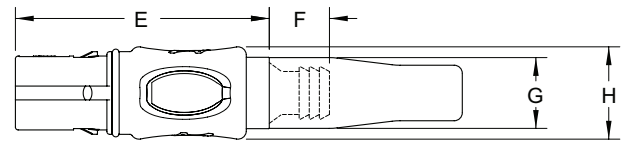

	HG0	HG2	HG3	HG4
<b>A</b>	Ø0.807 [20.50]	Ø1.014 [25.76]	Ø1.172 [29.77]	Ø1.250 [31.77]
<b>B</b>	0.728 [18.50]	1.220 [30.88]	1.220 [30.88]	1.220 [30.88]
<b>C</b>	Ø0.630 [16.00]	Ø.866 [22.00]	Ø1.007 [25.59]	Ø1.090 [27.80]
<b>D</b>	0.285 [7.25]	0.272 [6.91]	0.272 [6.91]	0.272 [6.91]
<b>E</b>	1.040 [26.38]	1.808 [45.92]	2.170 [55.07]	2.170 [55.07]
<b>F</b>	0.343 [8.71]	0.427 [10.84]	0.354 [9.00]	0.354 [9.00]
<b>G</b>	Ø0.370 [9.40]	Ø.502 [12.75]	Ø.650 [16.50]	Ø.710 [18.15]
<b>H</b>	Ø0.486 [12.34]	Ø.656 [16.66]	Ø.800 [20.36]	Ø.880 [22.47]
<b>J</b>	1.415 [35.94]	2.390 [60.65]	2.730 [69.33]	2.730 [69.33]
<b>K</b>	0.118 [3.00]	0.118 [3.00]	0.118 [3.00]	0.118 [3.00]
<b>L</b>	0.689 [17.50]	0.823 [20.90]	0.980 [24.90]	1.060 [76.90]
<b>M</b>	–	Ø.433 [11.00]	Ø.535 [13.60]	Ø.610 [15.50]
<b>N</b>	–	Ø.197 [5.00]	Ø.378 [9.60]	Ø.378 [9.60]
<b>P</b>	–	1.704 [43.27]	1.961[49.82]	2.124 [53.95]

► **PLUG & CABLE RECEPTACLE**

For HG2 only

**PLUG & CABLE RECEPTACLE MATED PAIR**  
with strain relief

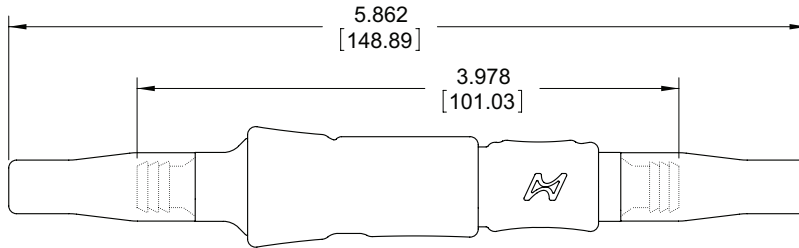

**[C] CABLE RECEPTACLE**  
with shielding option

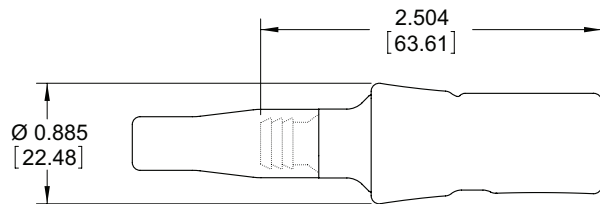

**[P] PLUG**

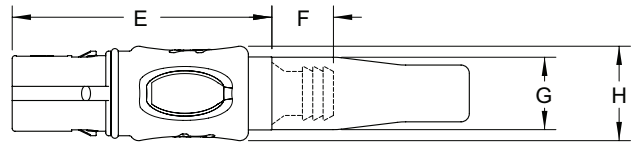

# KEYING & MOUNTING

## User Information

### ▶ RECEPTACLE KEYING

HG2 shown. All other sizes are keyed in the same fashion.  
See Assembly Instructions for receptacle keying information<sup>(1)</sup>:

- ▶ **S50386:** Panel Receptacles
- ▶ **S50431:** Cable Receptacles

**KEYING POSITION A**  
*Receptacle Wiring End*

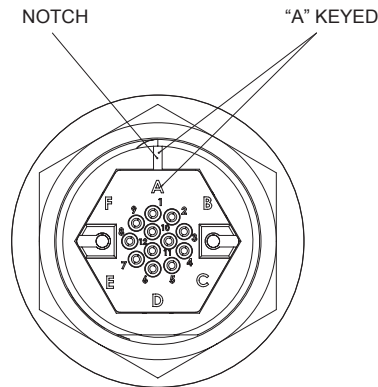

### ▶ PANEL CUTOUTS

All sizes

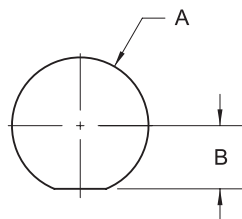

	A +0.002 -0.001 [+0.050 -0.030]	B ±0.001 [±0.030]
<b>HG0</b>	Ø0.555 [14.10]	0.240 [6.10]
<b>HG2</b>	Ø0.711 [18.06]	0.329 [8.36]
<b>HG3</b>	Ø0.870 [22.10]	0.393 [9.98]
<b>HG4</b>	Ø0.949 [24.10]	0.430 [10.92]

**Notes:**

1) Assembly Instructions also include plug keying information: S50387  
Dimensions are in inches [mm]



► RECEPTACLE MOUNTING OPTIONS

1 Assembly outside panel then install

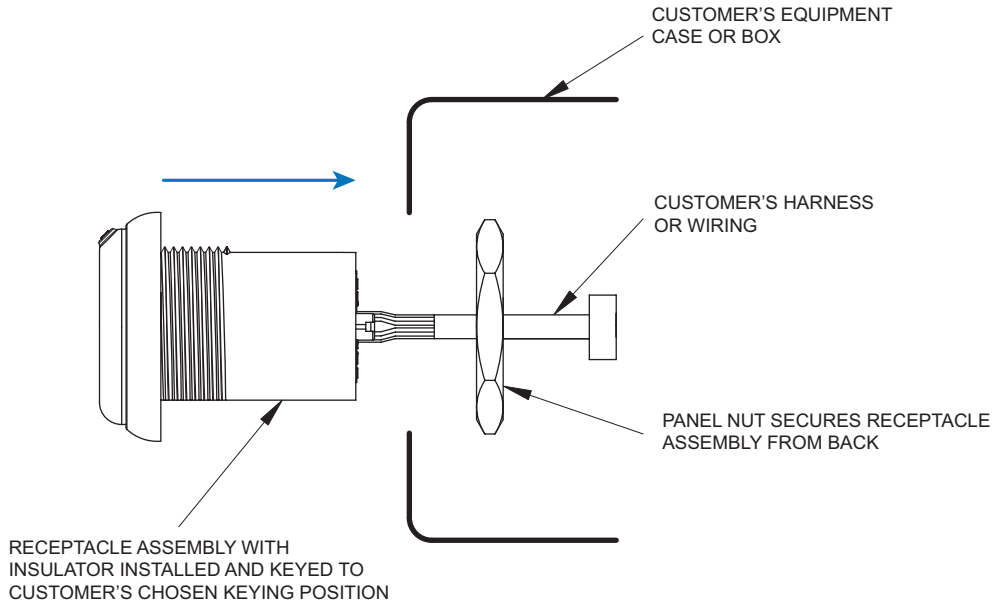

2 Install receptacle body then assemble inside panel

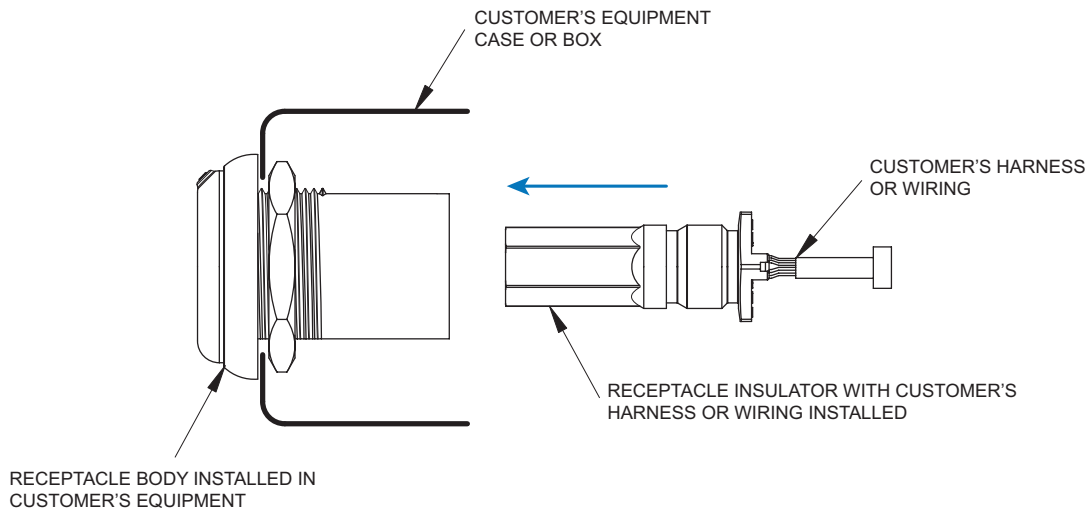

**Notes:**  
 Recommended tightening torque for panel mount receptacle for HG2, HG3 and HG4 is 0.452 to 0.678 N•m. For HG0 is 0.226 to 0.339 N•m.

# MARKETS & APPLICATIONS



## Catheter



- ▶ Disposable
- ▶ High density spring probe contacts
- ▶ High cycle life
- ▶ Low contact resistance
- ▶ Minimal insertion/extraction forces

## Home Healthcare



- ▶ Hyperboloid and USB signal contacts
- ▶ IP67 sealing
- ▶ Simplistic operation
- ▶ Ergonomic, ideal for in-home patient use

## MRI/CT Scanning



- ▶ Quick push/pull latching
- ▶ Hyperboloid signal contacts
- ▶ ESD finger-proof protection
- ▶ Multiple keying options

## Patient Monitoring



- ▶ Hyperboloid signal contacts
- ▶ Custom creepage and clearance
- ▶ High reliability
- ▶ Cost effective
- ▶ Patient friendly application

## Portable Therapeutic



- ▶ Custom cable solution
- ▶ Superior reliability for critical application
- ▶ Color coded
- ▶ Multiple keys to prevent mismatching
- ▶ Intuitive design

## Surgical Imaging



- ▶ Expanded beam Fiber Optic contact
- ▶ Easy cleaning and low susceptibility to contamination
- ▶ Fiber Optic video connection for easy mating to HD display system
- ▶ High speed data transmission

# HOW TO ORDER



**1** ▶ **HYPERGRIP CONNECTOR SERIES** *[Fixed]*

**2** ▶ **SIZE**

- 0** HG0    **2** HG2    **3** HG3    **4** HG4

**3** ▶ **TYPE**

- P** PLUG                      **E** RECEPTACLE/PANEL                      **C** RECEPTACLE/CABLE  
*(Available on HG2 only)*

**4** ▶ **CONNECTOR OPTIONS**

- 1** SEALED                      **2** SHIELDED *(Unsealed)*

**5** ▶ **STRAIN RELIEF SIZE** *(Cable diameter ranges)*

- 0** NO STRAIN RELIEF *(Panel receptacles only)*    **4** 4.50 - 6.50 mm *(HG2 only)*    **6** 9.00 - 11.00 mm *(HG4 only)*  
*(Shielded: 9.50 - 11.00mm)*  
**1** 2.08 - 3.10 mm *(HG0 only)*    **5** 7.00 - 9.00 mm *(HG3 only)*

**6** ▶ **OUTER SHELL COLOR** *[Fixed]*

- G** LIGHT GRAY

**7** ▶ **COLOR CODING** *(Strain relief only)*

- G** LIGHT GRAY *(Standard)*    **D** BLUE    **R** RED    **V** GREEN    **Y** YELLOW

**8** ▶ **POSITIONS**

- 5** HG0    **12** HG2    **19** HG3    **33** HG4

**9** ▶ **CONTACT DIAMETER**

- 03** HG0 (0.3mm)                      **04** HG2, HG3, HG4 (0.4mm)

**10** ▶ **CONTACT GENDER**

- F** FEMALE SOCKETS *(Receptacles)*                      **M** MALE PINS *(Plugs)*

**11** ▶ **TERMINATION** *[Fixed]*

- R** CRIMP/SOLDER *(26 - 28 AWG\*)*

*Contacts are shipped unloaded, may be crimped or soldered, then inserted into insulator.  
For more information, please see Assembly Instructions.*

**12** ▶ **PLATING** *(Pins: Gold over nickel    Sockets: Gold over nickel on contact surfaces, gold flash on terminations)*

- G** HG2, HG3, HG4 pins    **H** HG0 pins                      **ANH** HG2, HG3, HG4 sockets                      **AH** HG0 sockets

*\*Available tooling: Crimp Tool: AFM8 or M22520/2-01,  
Crimp Positioner: K1775 (HG0) or T2030 (HG2, HG3, HG4), Insertion Tool: T2080*

# AVAILABLE CONTACT TECHNOLOGIES

## Features & Benefits

### HYPERTAC® HYPERBOLOID



#### Long Contact Life

Industry-leading mating cycles provide low cost of ownership

#### Low Insertion / Extraction Forces

Ergonomic mating without cost and size of mate assist hardware

#### Lower Contact Resistance

Low power consumption / lower voltage drop across connector

#### Higher Current Ratings

Smaller contacts needed to carry power for reduced size and weight

#### Immunity to Shock & Vibration

Reliability under harsh environmental conditions

#### 360° Contact Wipe

Self-cleaning contacts assure uninterrupted connection

### SPRING PROBE



#### Extremely High Density

Allows for connectors as dense as 2mm, while maintaining 0.5mm of compliance

#### Shock & Vibration Resistant

Ensures stable connection in rough handling

#### Exceptional Misalignment Tolerance

Simplifies connector design, reducing cost of limited use side

#### High Cycle Life

Maintains electrical continuity for life of the device

#### Z-Axis Compliance

Ideal for blind mate engagement

### FIBER OPTIC



#### Two Standard Types

Size 16 Butt-Joint and Size 12 Expanded-Beam (EB) termini

#### Low Insertion Loss

Transmit high speed signals over longer distances without repeaters

#### Hermaphroditic Contacts (Butt Joint)

Same contact on both sides reduces total cost of ownership

#### Multi & Single-Mode Fiber Compatible (EB)

Ideal for high band width and voice signals

#### Low Susceptibility to Contamination (EB)

Reduced influence from dirt and debris across the connection

#### Immunity & Reliability

Resistant to EMI / RFI and crosstalk

### COAXIAL



#### 50Ω Characteristic Impedance

Meets application requirements for most RF interconnects

#### Crimp Termination for RG-405 Flex Cable

Faster termination to cable reduces applied costs

#### Low VSWR up to 40 GHz

Offers improved signal integrity

#### Magnetic Permeability: $30 \times 10^{-5} \mu_r$

Prevents image distortion in MRI environment applications

#### Immunity to Shock & Vibration

Reliability under harsh environmental conditions

#### Up to 20K Mating Cycles

Reduces cost of ownership in high cycle life applications

# EXAMPLE CONTACT ARRANGEMENTS

For Fiber Optic, Coax, Spring Probe & Hypertac® Hyperboloid

▶ **HG0**



12x SPRING PROBE CONTACTS

▶ **HG3**

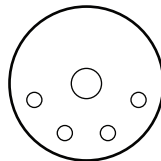

1x FIBER OPTIC CONTACT  
(Size 16 Butt-Joint or Size 12 Expanded Beam)  
4x HYPERBOLOID CONTACTS

▶ **HG4**

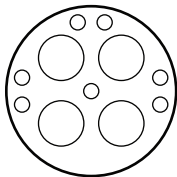

4x COAX CONTACTS  
7x HYPERBOLOID CONTACTS

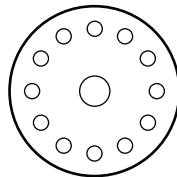

1x FIBER OPTIC CONTACT  
(Size 12 Expanded Beam)  
12x HYPERBOLOID CONTACTS

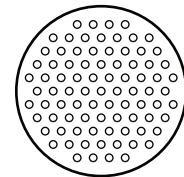

85x SPRING PROBE CONTACTS  
(Custom Mating Face)

EXAMPLE PART NUMBER	SIZE	TYPE	CONTACT ARRANGEMENT
<a href="#">HG3P15GG1BF/0404MRG</a>	HG3	Plug	1x Size 16 Butt-Joint FO and 4x Hyperboloid
<a href="#">HG3E10GG1BF/0404FRANH</a>	HG3	Receptacle	1x Size 16 Butt-Joint FO and 4x Hyperboloid
<a href="#">HG3P15GG1EB/0404MRG</a>	HG3	Plug	1x Size 12 Expanded Beam FO and 4x Hyperboloid
<a href="#">HG3E10GG1EB/0404FRANH</a>	HG3	Receptacle	1x Size 12 Expanded Beam FO and 4x Hyperboloid
<a href="#">HG4P16GG4CX/0704MRG</a>	HG4	Plug	4x Coax and 7x Hyperboloid
<a href="#">HG4E10GG4CX/0704FRANH</a>	HG4	Receptacle	4x Coax and 7x Hyperboloid
<a href="#">HG4P16GG1EB/1204MRG</a>	HG4	Plug	1x Expanded Beam FO and 12x Hyperboloid
<a href="#">HG4E10GG1EB/1204FRANH</a>	HG4	Receptacle	1x Expanded Beam FO and 12x Hyperboloid

**Note:**  
For additional configurations using Fiber Optic, Coax, Spring Probe and/or Hypertac® Hyperboloid contacts, please consult factory

# SMITHS CONNECTORS PRODUCT LINES

## Circular



- ▶ Metal and plastic
- ▶ Industrial M12, M23, M40, M58
- ▶ Crimp and solder terminations
- ▶ Push/pull latch mechanism
- ▶ Color coding

## EMI / EMP Filter

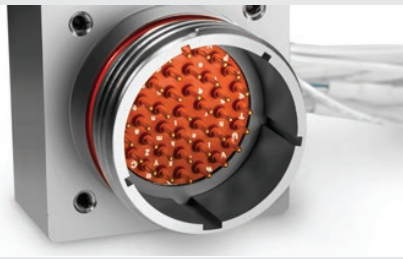

- ▶ EMI/RFI filtering and transient protection
- ▶ RoHS compliant solderless filter connectors available
- ▶ Filtered adapter for "bolt on" EMI/EMP solutions
- ▶ Filter hybrid capability
- ▶ Circular, ARINC, D-Subminiature, Micro-D

## Heavy Duty



- ▶ Modular solution: signal, power, data contacts and fiber optics
- ▶ EMC shielding
- ▶ High pressure up to 35K PSI, 250°C
- ▶ High temperature up to 440°C

## High Power

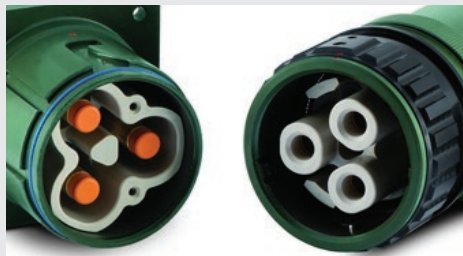

- ▶ Single and multi-way
- ▶ Circular and configurable rectangular
- ▶ Power contact up to 1,200 Amps
- ▶ Excellent performance in harsh environments

## High Speed Copper / Fiber

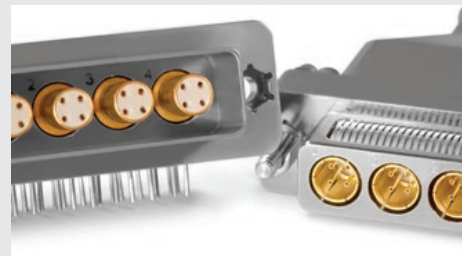

- ▶ Quadrax and Twinax connectors
- ▶ Fiber Optic Butt Joint, Expanded Beam and Floating Fiber Termini available
- ▶ ARINC and MIL-STD contacts

## Mil / Aero Standards



- ▶ Standard military interface
- ▶ ARINC 801
- ▶ ARINC interface
- ▶ Custom inserts

## Modular / Rectangular



- ▶ Configurable modules for signal, power, coax, fiber optic and/or pneumatics
- ▶ Guided hardware for blind mating
- ▶ Easy configuration in a single frame
- ▶ For rack & panel and cable applications

## PCB

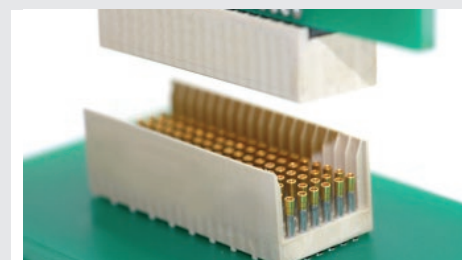

- ▶ Low, medium and high density board-to-board, cable to board and stacking
- ▶ Signal, power, coax and high speed configurations
- ▶ Numerous termination styles

## Spring Probe



- ▶ Z-axis compliant
- ▶ Blind mate engagement
- ▶ High density
- ▶ Extreme miniaturization
- ▶ High reliability, multi-cycle performance



# KENSINGTON

ELECTRONICS Inc.

*Not just products - Solutions!*

INTERNATIONAL,  
ALASKA & HAWAII

Please contact one  
of the ISRs.

**Courtney Darrah**

*Inside Sales Representative*  
cdarrah@keiconn.com  
512-339-3324

**Daegan Richmond**

*Inside Sales Representative*  
drichmond@keiconn.com  
512-339-3331

**Francisco Buxareo**

*Inside Sales Representative*  
fbuxareo@keiconn.com  
512-339-3302

**Gabby Bozeman**

*Inside Sales Representative*  
gbozeman@keiconn.com  
512-339-3325

**John Davis**

*Inside Sales Representative*  
jdavis@keiconn.com  
512-339-3311

## North American Sales Support Coverage



**Gabby Bozeman**

*Inside Sales Representative*  
gbozeman@keiconn.com  
512-339-3325

**Francisco Buxareo**

*Inside Sales Representative*  
fbuxareo@keiconn.com  
512-339-3302

**Daegan Richmond**

*Inside Sales Representative*  
drichmond@keiconn.com  
512-339-3331

**Courtney Darrah**

*Inside Sales Representative*  
cdarrah@keiconn.com  
512-339-3324

**John Davis**

*Inside Sales Representative*  
jdavis@keiconn.com  
512-339-3311