



百容電子股份有限公司

EXCEL CELL ELECTRONIC CO., LTD.

台中市40850台中工業區工業25路20號
No.20, 25th Rd., Taichung Industrial Park, Taichung, Taiwan 40850
Tel: 886-4-23591253(Rep)
Fax: 886-4-23593893, 23594667

TAIPEI OFFICE:

6F-9, No.1, Wuquan 1st Rd., Xinzhuang Dist., New Taipei City 24892 Taiwan
Tel: 886-2-22996268(Rep)
Fax: 886-2-22994795

www.ece.com.tw
info@mail.ece.com.tw

EXCEL CELL ELECTRONIC (USA) CORP.

50 Williams Parkway, Unit K East Hanover, NJ 07936 USA
Tel: +1-973-887-8116 ext 105
Fax: +1-973-8878117

www.ece-usa.com
mail@ece-usa.com



Short Form Catalog

- SWITCH
- RELAY
- TERMINAL BLOCK
- CONNECTOR
- RESETTABLE FUSE



ECE has more than 30 years of manufacturing experience in products such as Dip Switches, Terminal Blocks, Relays, and Connectors, etc. We satisfy all customers' requirements including quality, price, delivery by innovative processes and facilities, prompt production ability, advanced and automated assembly ability, and high precision testing facilities, etc.



Not only we have developed our products, but also developed manufacturing equipments which become the key success to achieve process integration and high production efficiency.

ECE is not just an electronic component manufacturer, but also a long-term strategic partner to form strategic alliances with our customers.



2000's 2000-Future

- 2018 - Merged Neocene Technology Co., Ltd. Certificate approval of LRQA IATF 16949:2016
- 2017 - Industrial Control Switch developed
- 2016 - Our Suzhou factory acquired the certificate approval of ISO/TS 16949.
- 2014 - Rotary Selector Switch developed.
- 2011 - Our CEO, Mr. Louis Liao, was chosen to be the head of Distinguished Citizens Society International.
- 2009 - Certificate approval of OHSAS-18001.
- 2008 - Certificate approval of LRQA TS-16949.
- 2006 - Another Suzhou factory in China was founded.
- 2004 - Merged TTOP Corporation and Good Sky Electric Co., Ltd.
- 2003 - Suzhou factory in China was founded.
- 2002 - Micro Switch developed
- 2001 - Went public in Taiwan Stock Exchange market. Resettable Fuse developed
- 2000 - Certificate approval of LRQA ISO 14001.

1990's 1990-1999

- 1998 - Dongguan factory in China was founded.
- 1997 - Connector developed.
- 1996 - U.S.A. branch office was founded.
- 1995 - Certificate approval of LRQA ISO 9001.
- 1990 - Terminal Block developed.

1980's 1980-1989









- 1987 - Automatic production lines were set up.
- 1983 - Dip Switch and Reed Relay developed.
- 1981 - ECE founded and button cell was our initial product.

INDEX

Green Products Are Available at ECE!

Switches	Industrial Control Switch	P4-5
	Rotary Switch	P6~9
	DIP Switch	P10~12
	Micro Switch	P13
	Other Switch	P14
Relays	Optical	P15
	Solid State Relay	P16
	Reed Relay & Sensor	P17~18
	Electromagnetic Relay	P19~26
Terminal Block		P27~35
Connector		P36~40
Resettable Fuse		P41

Industrial Control Switch NEW

Features	Pushbutton	Selector	Key Selector	Emergency Stop	Pilot Lamp
Pictures					
Series	ECS-P/E3-Q	ECS-S/SL-Q	ECS-K-Q	ECS-E1-Q	ECS-L-Q
Mounting Diameter	Ø22, Ø25, Ø30mm				
Operating Temperature	-25°C ~ +70°C (without icing or condensation) -25°C ~ +55°C (for illuminated type)				
Rated Thermal Current	10A				
Rated Insulation Voltage	650V				
Contact Resistance	50mΩ max. (initial)				
Insulation Resistance	100MΩ min. at 500VDC				
Dielectric Strength	2500VAC, 1min.				
Connection Type	M3.5 Screw Connection				
Safety	   				
Degree of protection	IP65 (from the front of the panel)				

Structure

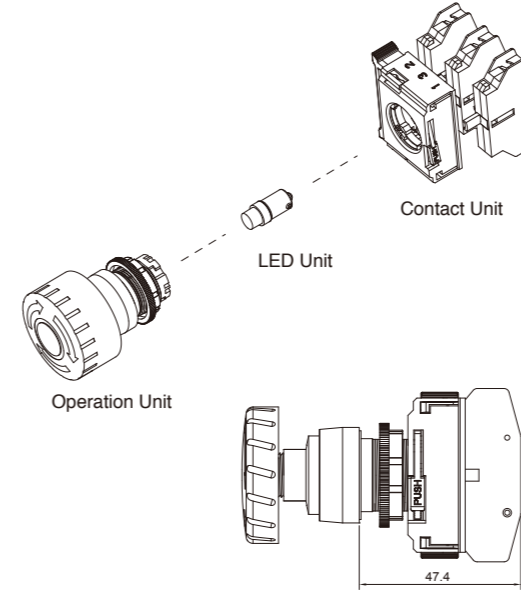

Operation Unit

LED Unit

Contact Unit

Panel Cutout

■ Cutout diameter and distance

	22R / 25R	22Q / 25Q	30R
A	22.3 / 25.3 ^{+0.4} ₋₀	22.3 / 25.3 ^{+0.4} ₋₀	30.5 ^{+0.5} ₋₀

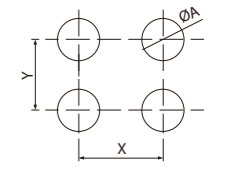

	22R / 25R	22Q / 25Q	30R	Long Lever Selector Switch Emergency Stop Switch
X	50	50	50	50
Y	55	55	65	55

■ Key recess cutout (22mm only)

Mounting Hole(Ø)	a	b
22	24.1/25.3 ^{+0.5} ₋₀	3.2 ^{+0.2} ₋₀

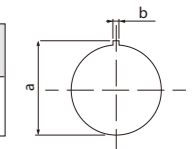

■ All models offer the flexibility of modular construction, which allows you to change contact blocks, lamp voltage, or button color easily.
 ■ Accessories are available upon request.

Industrial Control Switch



Features	Emergency Stop
Pictures	
Series	ECS -A16RE1
Mounting Diameter	Ø16mm
Operating Temperature	-25°C ~ +60°C (no freezing)
Rated Thermal Current	5A
Rated Insulation Voltage	250V
Contact Resistance	50mΩ max.(initial)
Insulation Resistance	100MΩ min. at 500VDC
Dielectric Strength	2500VAC, 1min.
Connection Type	Faston terminal 2.8 X 0.5mm
Approvals	(Pending)

Structure

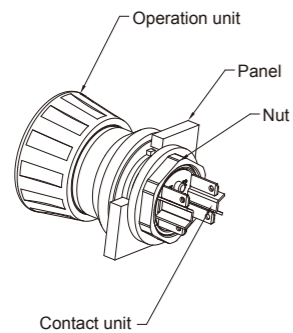

Panel Cutout

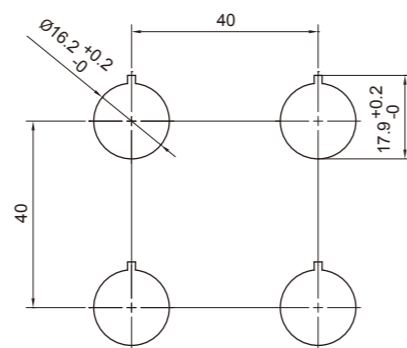

Dimensions

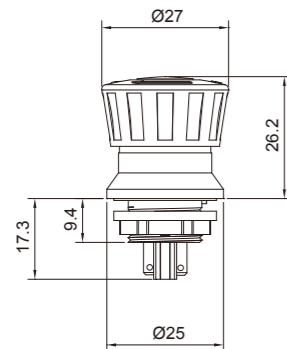

Rotary Switch

Features	ROTARY (Miniature Size)						
Pictures	 3:3	 3:3	 3:3	 3:3	 3:2	 5:0	 3:3
Series	ERD7(SMT)	ERD7(THR)(TH)	ERD7(RA)	ERD7(RA)(SMT)	ERD7(RA&TH)	ERD7(RA&SMT)	ERD7(J-HOOK&SMT)
Contact resistance (Initial)	200mΩ Max.	200mΩ Max.	200mΩ Max.	200mΩ Max.	200mΩ Max.	200mΩ Max.	200mΩ Max.
Operation force (Max.)	510gf-cm	510gf-cm	510gf-cm	510gf-cm	510gf-cm	510gf-cm	510gf-cm
Options	Gray Code available 		Special shaft available 		Special Marking available 		

Quick Selection Guide

Size	Positions	Code	Setting position	Pin out	Shape of terminal	Part number
7x7	8,10,16	Real Complement Gray	Top Setting	3:3	Standard	ERD7xxxSZ
					SMT	ERD7xxxMZ
					SMT in T&R	ERD7xxxDZ
					SMT with J-hook	ERD7xxxCZ
					SMT with J-hook in T&R	ERD7xxxEZ
			Side Setting	3:3	Right Angle	ERD7xxxRZ
						ERD7xxxFZ
				3:2		ERD7xxxHZ
					5:0	SMT with Right Angle
				SMT with Right Angle in T&R		ERD7xxxLZ
					ERD7xxxTZ	
					ERD7xxxUZ	

Dimensions

ERD7 Surface Mounting Type

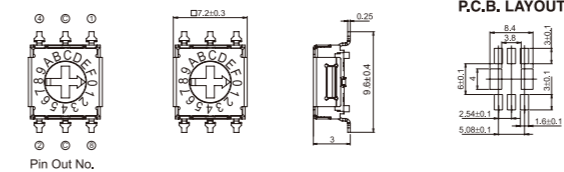

ERD7 Right Angle Type

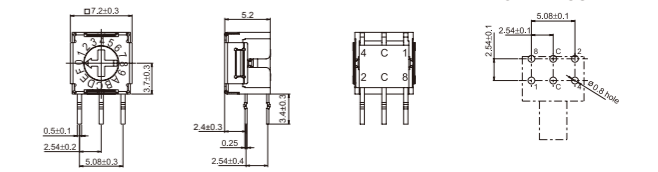

ERD7 Through Hole Reflow / Through Hole Type

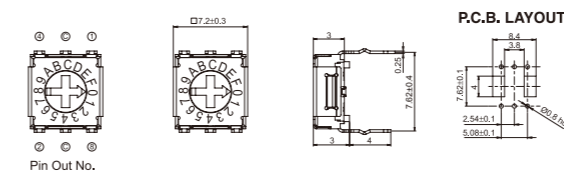

ERD7 Right Angle SMT Type

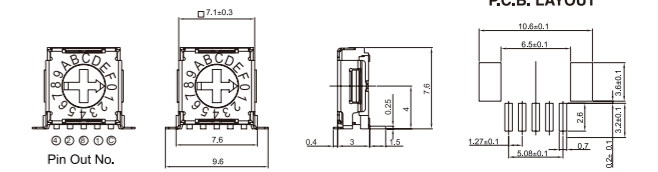

ERD7 J-hook SMT Type

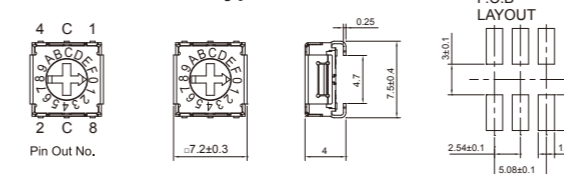

ERD7 Right Angle Through Hole Type

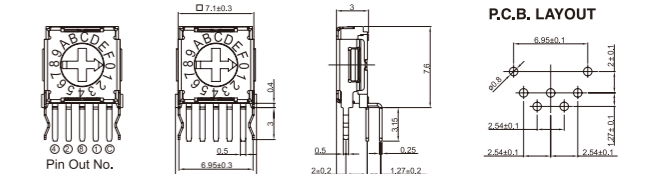

Rotary Switch

Features	ROTARY SELECTOR (Miniature Size)				
Pictures					
Series	ERD6(SMT)	ERD6(THR)(TH)	ERD6(RA)	ERD6(RA)(SMT)	ERD6(J-Hook&SMT)
Contact resistance (Initial)	200mΩ Max.	200mΩ Max.	200mΩ Max.	200mΩ Max.	200mΩ Max.
Operation force (Max.)	510gf-cm	510gf-cm	510gf-cm	510gf-cm	510gf-cm
Options	1.Special marking available 2.Special shaft available S type H type				

Quick Selection Guide

Size	Positions	Circuit type	Setting position	Pin out	Shape of terminal	Part number
7x7	4	1 pole 4 contacts	Top Setting	3 : 3	THR with row spacing 7.62mm	ERD6xxxSZ
					SMT with gull wing	ERD6xxxMZ
					SMT with gull wing in T&R	ERD6xxxDZ
					SMT with J-hook	ERD6xxxCZ
			Side Setting	3 : 3	SMT with J-hook in T&R	ERD6xxxEZ
					Right Angle	ERD6xxxRZ
					SMT with Right Angle	ERD6xxxKZ
					SMT with Right Angle in T&R	ERD6xxxGZ

Dimensions

unit: mm(inch)

ERD604ASZ

ERD604AKZ

ERD604AMZ

ERD604ARZ

ERD604ACZ

Rotary Switch

Features	ROTARY				
Pictures					
Series	ERD1	ERD2	ERD4	ERD5	ERD1XXA/B
Contact resistance (Initial)	100mΩ Max.	100mΩ Max.	100mΩ Max.	100mΩ Max.	100mΩ Max.
Operation force (Max.)	500gf-cm	500gf-cm	500gf-cm	500gf-cm	500gf-cm
Options	Tape & Reel package	Shaft cover	Tape & Reel package	Shaft cover	Shaft
Others	Special marking available upon request!				

Quick Selection Guide

Size	Positions	Code	Pin out	Rotor	Type	Part number	
10x10	8,10,16	Real, Complement	3:3	Flat, Shaft	Standard	ERD1xxxSZ, ERD2xxxSZ	
					Right angle	ERD1xxxR/FZ, ERD2xxxR/FZ	
					Flat	SMT	ERD1xxxMZ, ERD2xxxMZ
						SMT in T&R	ERD1xxxDZ
				Flat, Shaft	Standard	ERD4xxxSZ, ERD5xxxSZ	
					Right angle	ERD4xxxR/FZ, ERD5xxxR/FZ	
					Flat	SMT	ERD4xxxMZ
						SMT in T&R	ERD4xxxDZ

Dimensions

unit: mm(inch)

ERD1xxxMZ Flat Type

ERD2xxxSZ Shaft Type

ERD4xxxRZ Flat Type

ERD1xxA/BZ

Rotary Switch

Features	ROTARY			
Pictures				
Series	ERD9		ERDA	
Contact resistance (Initial)	80mΩ Max.		80mΩ Max.	
Operation force (Max.)	500gf-cm		500gf-cm	
Options	Tape & Reel package			
Others	Special marking available upon request!			

Quick Selection Guide

Size	Positions	Code	Pin out	Rotor	Type	Part number
10x10	10,16	Real, Complement	3:3	Flat, Shaft	Standard	ERD9xxxSZ, ERDAXxxSZ
					Right angle	ERD9xxxR/FZ, ERDAXxxR/FZ
				Flat	SMT	ERD9xxxMZ, ERDAXxxMZ
					SMT in T&R	ERD9xxxDZ

Dimensions

ERD9XXXMZ Flat Type

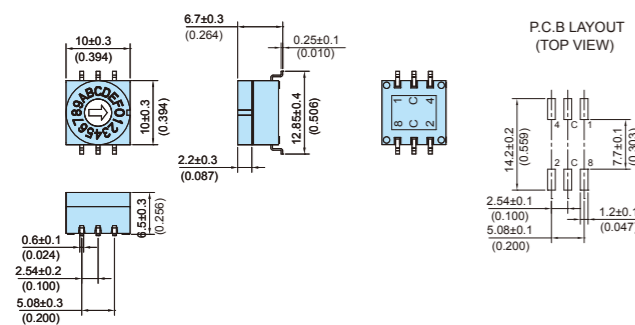

ERDAXXXSZ Shaft Type

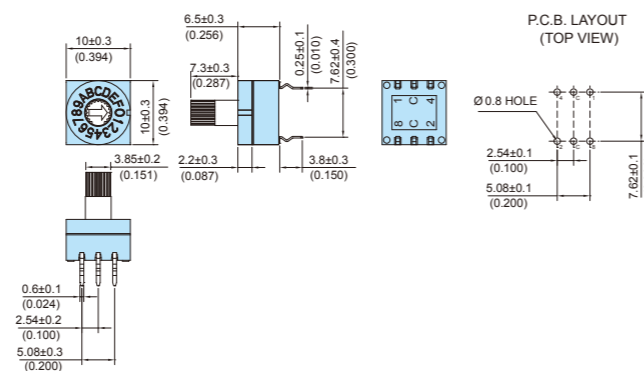

ERD9XXXFZ Flat Type Right Angle Type Pitch : 5.08mm

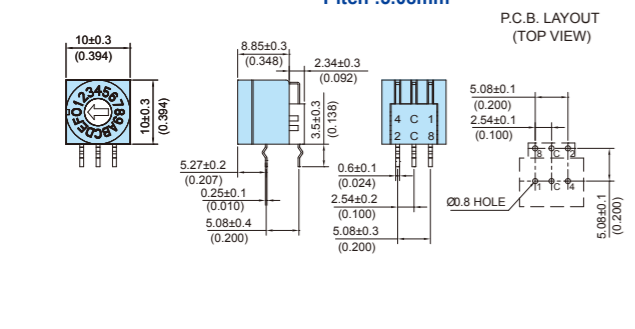

ERD9XXXS04Z

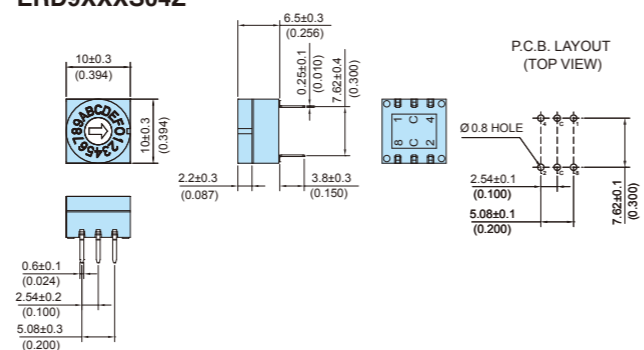

DIP Switch

Features	HALF PITCH	END-STACKABLE			AUTO INSERTING	
	SMT	SMT	SMT	SMT	SMT	SMT
Pictures						
Series	EHS	ESD	ESL	EAM	EAD	EAH
Contact form	SPST	SPST	SPST	SPST	SPST	SPST
Pitch / mm(inch)	1.27(0.05)	2.54(0.1)	2.54(0.1)	2.54(0.1)	2.54(0.1)	2.54(0.1)
No. of positions	2, 4, 6, 8, 10	1-12	2-12	1-12	2-12	2-12
Contact rating	25mA 24VDC	25mA 24VDC	25mA 24VDC	25mA 24VDC	25mA 24VDC	25mA 24VDC
Contact resistance (Initial)	100mΩ Max.	50mΩ Max.	50mΩ Max.	50mΩ Max.	50mΩ Max.	50mΩ Max.
Insulation resistance	500MΩ Min. at 100VDC	1000MΩ Min. at 100VDC				
Operation force (Max.)	800gf	800gf	800gf	800gf	800gf	800gf
Dielectric strength	300VAC Min. for 60 sec.	500VDC Min. for 60 sec.				
Mechanical life	1000 operations	2000 operations				
Options	Tape & Reel package	Tape & Reel package	Tape & Reel package	Tape & Reel package	Tape & Reel package	Tape & Reel package
Dimensions unit:mm(inch)						

DIP Switch

Features	TRI-STATE			SLIDE	
	SMT				Right Angle
Pictures					
Series	ETS	ETA	ETD	EDG/S	EDG(S)xxxSRA
Contact form	SPST	SPST	SPST	SPST, DPST, SPDT, 3PST, 4PST, DPDT	SPST, DPST, 3PST, 4PST
Pitch / mm(inch)	2.54(0.1)	2.54(0.1)	2.54(0.1)	2.54(0.1)	2.54(0.1)
No. of positions	2-12	2-12	4-10	1-15	1-15
Contact rating	25mA 24VDC	25mA 24VDC	25mA 24VDC	25mA 24VDC	25mA 24VDC
Contact resistance (Initial)	50mΩ Max.	50mΩ Max.	50mΩ Max.	50mΩ Max.	50mΩ Max.
Insulation resistance	1000MΩ Min. at 100VDC				
Operation force (Max.)	800gf	800gf	800gf	800gf	800gf
Dielectric strength	500VDC Min. for 60 sec.				
Mechanical life	2000 operations				
Options	Tape & Reel package				
Dimensions unit:mm(inch)					

DIP Switch

Features	PIANO				SLIDE	
		SMT				
Pictures						
Series	EHP (Half Pitch)	EPA	EPH	EPG/EPS	ESP	ESP42
Contact form	SPST	SPST	SPST	SPST, DPST, SPDT, 3PST, 4PST, DPDT	SPDT	4PDT
Pitch / mm(inch)	1.27(0.05)	2.54(0.1)	2.54(0.1)	2.54(0.1)	2.54(0.1)	2.54(0.1)
No. of positions	2, 4, 6, 8, 10	2, 3, 4, 5, 6, 8, 10	2, 3, 4, 5, 6, 8, 10	2-12
Contact rating	25mA 24VDC	25mA 24VDC	25mA 24VDC	25mA 24VDC	200mA 24VDC	500mA 12VDC
Contact resistance (Initial)	100mΩ Max.	50mΩ Max.	50mΩ Max.	50mΩ Max.	50mΩ Max.	100mΩ Max.
Insulation resistance	100MΩ Min. at 100VDC	1000MΩ Min. at 100VDC			10000MΩ Min. at 500VDC	1000MΩ Min. at 100VDC
Operation force (Max.)	800gf	800gf	800gf	800gf	800gf	1000gf
Dielectric strength	300VAC Min. for 60 sec.	500VDC Min. for 60 sec.				
Mechanical life	1000 operations				5000 operations	1000 operations
Options	Tape & Reel package	Tape & Reel package			Straight pin, Right angle type, SMT type, Gull-wing type	Pitch: 7.62mm, 8.5mm, 9.6mm(SMT)
Dimensions unit:mm(inch)						







Micro Switch

Features		COMPACT SIZE		GENERAL USE		
Pictures						
Series		EJF		ESS	ESW	
Rating		AC 125V 1A/3A DC 30V 0.05A		AC 125V 0.1A, 5A / AC 250V 3A, 10.1A / DC 30V 0.1A	AC 125V 5A/ 250V 3A DC 30V 3A	
Contact form		1a,1b,1c		1a,1b,1c	1a,1b,1c	
Pitch / mm (inches)		5.08(0.2)		pls refer to our detailed spec.		
Initial contact resistance (Max.)		100mΩ		(0.1A):50-150mΩ, (5A/10A):30-50mΩ	200mΩ	
Insulation resistance		100MΩ Min. at 500VDC				
Operation force(gf)		75gf,150gf		25gf,50gf,150gf	180gf	
Dielectric strength (for 60 sec.)	Pin to Pin	1000VAC Min.		(0.1A):600VAC, (5A/10A):1000VAC	1000VAC	
	Pin to metal parts			1500VAC	1500VAC	2000VAC
	Pin to Ground			1500VAC	1500VAC	2000VAC
Mechanical life		1x10 ⁶ cycles		(0.1A/5A):30x10 ⁶ cycles, (10.1A):10x10 ⁶ cycles	5x10 ⁶ cycles	
Electronical life		30x10 ³ cycles		(0.1A/5A):200x10 ³ cycles, (10.1A):50x10 ³ cycles	1x10 ⁵ cycles	
Dimensions unit:mm(inch)		12.8Lx5.8Wx6.5H P/N: EJF1121000	12.8Lx5.8Wx6.5H P/N: EJF1113000	19.8Lx6.4Wx10.2H P/N: ESS05103 #110 Quick connect terminal	21.2Lx6.4Wx16.9H P/N:ESW57A100100 Lead wire straight type	
		General tolerance ±0.4mm	General tolerance ±0.4mm	General tolerance ±0.4mm	General tolerance ±0.4mm	













Other Switch

Products	DETECTOR SWITCH	PUSH BUTTON SWITCH	THUMBWHEEL SWITCH
Pictures			
Series	EDT	EPU	EX08
Rating	12VDC,100mA	30VDC,0.1A	1A
Contact form	DPDT (ON-OFF,ON-ON)
Terminal type	SMT	PC Terminal
Pitch / mm (inch)		5.08
Initial contact resistance (Max.)	1Ω	30mΩ	100mΩ
Insulation resistance (pin to pin) Min.	100MΩ	100MΩ	100MΩ
Operation force (gf)	Center puch	50gf
	4-directional	
Dielectric strength(for 60 sec.)	100VAC	250VAC	
Mechanical life	50x10 ³ cycles	10x10 ³ cycles	200x10 ³ cycles
Options/others	Tape & Reel package		blank section
Dimensions unit:mm(inch)	 P.C.B. Layout (Top View)	8x8 FULL STROKE	33x30.5











Optical

Products	MOS RELAY			MOS-FET DRIVER
Pictures				
Series	EPR4	EPR2	EPR3	EPV
Features	SOP package	DIP package	SMD package	DIP/SMD/SOP package
Outline Dimension (without terminals) LxWxH (mm)	4p:4.7x4.4x2	4p:4.7x6.4x3.4		(DIP/SMD) 4p:4.7x6.4x3.4 (SOP) 4p:4.7x4.4x2
	6p:6.3x4.4x2	6p:8.8x6.4x3.4		8p:9.78x6.4x3.4 8p:9.3x4.4x2
	8p:9.3x4.4x2	8p:9.78x6.4x3.4		
Contact form	1A,1B,1C,2A,2B	1A,1B,1C,2A,2B	
Pin out	4pin, 6pin, 8pin			4pin, 8pin
Output	Voltage	20-600V	20-600V	8V
	Current	0.04-2.5A	0.03-6.0A	20μA
Control input	5-50mA	5-50mA		5-50mA
I/O Isolation voltage	1500VAC/ 2500VAC	2500VAC/ 3750VAC/ 5000VAC		SOP: 2500VAC DIP/SMD: 3750VAC
I.R.	5x10 ⁹ Ω	5x10 ⁹ Ω		5x10 ⁹ Ω
Time	T _{on} (Max.)	5ms	5ms	0.2ms
	T _{off} (Max.)	2ms	2ms	0.05ms
On-state resistance	0.1-60Ω	0.1-160Ω	
Option	For SOP, SMD type, Tape & Reel package available			
Others				







Solid State Relay

Products	PCB MOUNT	SLIM TYPE	MINI TYPE	POWER TYPE	3-PHASE TYPE	I/O MODULES				
Pictures										
Series	ESR2	ESR3	ESR4	ESR5	ESR6	ESR8				
Features	SIP standard package	SIP slim package	SIP mini package	1 phase power type	3 phase power type	I/O modules				
Outline dimension (without terminals) LxWxH(mm)	43.2x10.2x25.4	28x5x15	20x5x17	57x43x27.1	104x74x29.5	44x15x33				
Contact form	1A	1A	1A	1A	1A	1A				
Output	Voltage	DC 24V 60V	AC 120V 240V 48V 380V	DC 24V 240V	AC 240V	120,240, 380,480VAC 60VDC 100VDC	240,480VAC DC 60V AC 240V			
	Current	3,7A	3A	1.0-4A	2A	4A	1A	10,12,25,40A	10,25,40A	3A
Control input	DC 3-32V		5V 12V 24V,48V	5V 12V 24V	DC 3V AC 50V 32V	AC 280V	DC 3V AC 32V	DC 3V AC 90V 32V 280V		
	I/O B/D Voltage	2.5K VAC 3.5K VAC	2.5K VAC 3.5K VAC	2.5K VAC	3.5K VAC	3.5K VAC	3.5K VAC	3.5K VAC		
I.R.	10 ⁸ Ω	10 ⁹ Ω	10 ⁹ Ω	10 ⁹ Ω	10 ⁹ Ω	10 ⁸ Ω				
Time	T _{on} (Max.)	Zero-on: 8.3ms Random-on: 100μs	150μs	Zero-on: 8.3ms Random-on: 150μs	DC 2ms	Zero-on: 8.3ms Random-on: 2ms	Random-on: 100μs	8.3ms	DC 50μs AC 8.3ms	
	T _{off} (Max.)	8.3ms	600μs	10ms	0.1ms	9.3ms	8.3ms	20ms	8.3ms	100μs
On-state	1.5V	0.24V 0.6V	1.2V	0.24V	1.5V	1.6-1.8V	1.6-1.8V	1.0V	1.5V	
Safety										
Options	w/LED				w/LED w/Heatsink	Heatsink				

Reed Relay

Products	IC TYPE								
Pictures									
Series	EDR1	EDR2	EDR3	EDR4	EDR5	EDR6	EDR7	EDR8	
Features	SIP package	DIP package	SMD package	MINI SIP package	MINI DIP package	MINI SMD package	MINI SOJ package	MINI SIP package	
Outline dimensions (without terminals) LxWxH (mm)	19x5.2x7	19.9x6.9x5.5	19.9x6.9x5.5	12.1x4.3x6.0	17x4.4x4.5	17x4.4x4.5	17x4.4x4.5	14.9x3.81x6.8	
Contact form	1A	1A,1B,1C,2A	1A,1B,1C,2A	1A	1A	1A	1A	1A	
Output	Voltage	100VDC		100VDC	100VDC				
	Current	0.5A		0.5A	0.5A				
Control input (nominal)	DC 3V			DC 5V	DC 5V				
	5V			12V	12V				
	12V								
	24V								
Input imped.	500-2.2KΩ	140-2.2KΩ	140-2.2KΩ	250-750Ω	150-600Ω			500-1KΩ	
I/O B/D Voltage	1400VDC			1500VDC	500VDC			1500VDC	
I.R.	10 ¹⁰ Ω			10 ⁹ Ω	10 ⁹ Ω			10 ⁹ Ω	
Time	T _{on} (Max.)	1ms		1ms	1ms			1ms	
	T _{off} (Max.)	0.5ms		0.5ms	0.5ms			0.5ms	
Contact resistance	150mΩ			200mΩ	200mΩ			200mΩ	
Safety				
Options	w/Diode	w/Diode w/Electrostatic shield	w/Diode w/Electrostatic shield	w/Diode	w/Magnetic shield cover			w/Diode	
	w/Magnetic shield cover	w/Magnetic shield cover	w/Magnetic shield cover					w/Magnetic shield cover	

Reed Relay

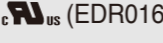
Products	CONVENTIONAL TYPE	LINE SENSOR TYPE	LEVEL SENSOR	REED SENSOR		
Pictures						
Series	EDR001-016	EDR018	ELS1	ELS RS	ELS 3	ELS 4
Features	General type	Line sensor type	Level Sensor	Reed Sensor	Reed Sensor	Reed Sensor
Outline dimensions (without terminals) LxWxH (mm)	several size & pin-out, pls refer to our detailed spec.	30x13x12.8	Please refer to our detailed spec.	Please refer to our detailed spec.	Please refer to our detailed spec.	Please refer to our detailed spec.
Contact form	1A,1B,1C,2A,2B	1A	1A,1B	1A	1A	1A
Output	Voltage	100VDC	100VDC
	Current	0.5A	0.5A
Control input (nominal)	DC 3V	DC 15mA
	5V					
	6V					
	8V					
Input imped.	500-2KΩ	7-18Ω
	500-3750VAC	3000VAC
I.R.	10 ⁸ Ω		10 ⁹ Ω	10 ¹⁰ Ω	10 ¹⁰ Ω
Time	T _{on} (Max.)	1ms
	T _{off} (Max.)	0.5ms
Contact resistance	150mΩ		150 mΩ	100 mΩ 200 mΩ(ELS 303)	100 mΩ 200 mΩ(ELS 403)
Safety		
Options	Plastic cap type, Magnetic shield type		different wire length upon request	Customized dimensions upon request	Customized dimensions upon request

Electromagnetic Relay

		GENERAL PURPOSE			
Appearance					
Series classification		ETR GCJ	ETR JMT	ETR LR	ETR SMIT
Outline(LxWxH)mm		20.4 x 7.0 x 15.0	15.7 x 12.2 x 13.7	28.0 x 5.0 x 15.0	24.5 x 10.5 x 24.8
Weight		4g	5.2g	6g	10.2g
Contact Form		SPST	SPST	SPST/SPDT	SPST
Contact rating (Resistive Load)		5A/277VAC 5A/30VDC	5A/120VAC 5A/30VDC TV-5/120VAC	8A/277VAC 8A/30VDC	10A/30VDC 10A/250VAC TV-5/120VAC
Nominal Coil Voltage (V)	DC	3, 5, 6, 9, 12, 15, 18, 24	3, 5, 6, 9, 12, 24	3, 4.5, 5, 6, 9, 12, 15, 18, 24	3, 5, 6, 9, 12, 24, 48
	AC	----	----	----	----
Coil Power Consumption		0.2W	0.54W	3-24V: 0.17W	DM Type: 0.54W LM Type: 0.25W
PCB Layout (Bottom View)					

		GENERAL PURPOSE			
Appearance					
Series classification		ETR JE	ETR JQ	ETR EMI-2P (New structure)	ETR EMI-1P
Outline(LxWxH)mm		20 x 10 x 10.5	20.1 x 10.0 x 16.0	29.4 x 12.8 x 17.5	29.0 x 12.6 x 15.8
Weight		6.0 g	5.6g	14.2g	12.5g
Contact Form		SPST/SPDT	SPST/SPDT	DPST/DPDT	SPST/SPDT
Contact rating (Resistive Load)		1A: 8A/250VAC 1C: 5A/250VAC 8A/30VDC 5A/30VDC	1A: 10A/125VAC 1C: 5A/250VAC NO: 10A/125VAC NC: 5A/125VAC 5A/30VDC	8A/250VAC 8A/30VDC	12A/250VAC 12A/30VDC
Nominal Coil Voltage (V)	DC	3, 5, 6, 9, 12, 24, 48	3, 5, 6, 9, 12, 24	5, 6, 9, 12, 15, 18, 24, 48, 60, 110	6, 9, 12, 15, 18, 24, 48, 60, 110
	AC	----	----	24, 115, 230	24, 115, 230
Coil Power Consumption		0.2W	DM / D Type: 0.45W TM / T Type: 0.4W LM Type: 0.2W	DC Coil: 0.4W~0.5W AC Coil: 0.61~0.88VA	DC Coil: 0.4W AC Coil: 0.61~0.88VA
PCB Layout (Bottom View)					

Electromagnetic Relay

		GENERAL PURPOSE			
Appearance					
Series classification		ETR EZ	ETR EZI	ETR MI/MIH/MIT	ETR MI-2P
Outline(LxWxH)mm		29.0 x 12.6 x 15.8	29.0 x 12.6 x 15.8	29.1 x 13.0 x 20.6	29.1 x 12.8 x 20.6
Weight		12.5g	15g	12.2g	13.8g
Contact Form		SPST/SPDT	SPST/SPDT	SPST/SPDT	DPDT/DPST
Contact rating (Resistive Load)		20A/120VAC 1/2HP/250VAC 16A/250VAC 16A/30VDC	12A/250VAC 12A/30VDC	MI 10A/250VAC MIT 10A/240VAC MIH 16A/240VAC 16A/24VDC	5A/250VAC 5A/30VDC TV-3/120VAC
Nominal Coil Voltage (V)	DC	6, 9, 12, 15, 18, 24, 48, 60, 110	6, 9, 12, 15, 18, 24, 48, 60, 110	3, 5, 6, 9, 12, 24, 48	3, 5, 6, 9, 12, 15, 18, 21, 24, 28, 48
	AC	24, 115, 230	24, 115, 230	----	----
Coil Power Consumption		DC Coil: 0.4W AC Coil: 0.61~0.88VA	DC Coil: 0.4W AC Coil: 0.61~0.88VA	D Type: 0.72 W L Type: 0.54W	D Type: 0.72 W L Type: 0.54W
PCB Layout (Bottom View)					

		GENERAL PURPOSE			
Appearance					
Series classification		ETR GQ	ETR GQ	ETR GJ	ETR RW/RWH
Outline(LxWxH)mm		18.2 x 10 x 14.9	18.2 x 10 x 15	18.3 x 10.2 x 15.8	19.0 x 15.4 x 15.0
Weight		9g		5.4g	9g
Contact Form		SPST	SPST	SPST/SPDT	SPST/SPDT
Contact rating (Resistive Load)		5A/250VAC 5A/30VDC	10A/250VAC 10A/30VDC 12A/125VAC TV-5/120VAC	16A/277VAC 16A/24VDC TV-8/120VAC	1A: 12A/120VAC 1C: 6A/125VAC 3A/250VAC 6A/30VDC RW: 10A/24VDC RWH: 1800W 15A/120VAC TV-5/120VAC
Nominal Coil Voltage (V)	DC	3, 5, 6, 9, 12, 15, 24, 48	5, 6, 9, 12, 15, 24, 48, 60	3, 5, 6, 9, 12, 24	3, 5, 6, 9, 12, 18, 24, 36, 48
	AC	----	----	----	----
Coil Power Consumption		0.2W	0.36W	D Type: 0.45W L Type: 0.2W	0.36W
PCB Layout (Bottom View)					

Electromagnetic Relay

		GENERAL PURPOSE			
Appearance					
Series classification		ETR RUDH/RUUH	ETR RUT	ETR UDH	ETR EML
Outline(LxWxH)mm		20.5 x 16.7 x 20.3	20.5 x 16.7 x 20.3	22.0 x 16.8 x 14.7	29.0 x 12.6 x 15.7
Weight		12.2g	11.4g	9.5g	12.5g
Contact Form		SPST/SPDT	SPST	SPST/SPDT	SPST
Contact rating (Resistive Load)		RUDH: 12A/120VAC RUUH: 15A/120VAC 12A/24VDC 15A/30VDC	TV-5/120VAC 15A/125VAC 15A/125VAC 15A/125VAC 10A/250VAC 10A/250VAC 5A/30VDC 5A/30VDC	12A/120VAC 12A/24VDC	16A/277VAC
Nominal Coil Voltage (V)	DC AC	3, 6, 9, 12, 24, 48 ----	3, 5, 6, 9, 12, 15, 18, 24, 48 ----	3, 5, 6, 9, 12, 24, 48 ----	3, 5, 6, 9, 12, 15, 18, 24, 48, 60 ----
Coil Power Consumption		3-24V: 0.45W 48V: 0.51W	3-24V: 0.36W 48V: 0.51W	3-24V: 0.45W 48V: 0.66W	0.4W
PCB Layout (Bottom View)					



		GENERAL PURPOSE			
Appearance					
Series classification		ETR SF/SFG		ETR EMR	ETR EMF
Outline(LxWxH)mm		SF: 22.2 x 16.2 x 11.0	SFG: 22.2 x 25.0 x 11.5	30 x 10 x 15	H Type: 44.5 x 12.6 x 15.7 V Type: 41 x 12.6 x 15.7
Weight		SF: 8.5g	SFG: 9g	11.0 g	14g
Contact Form		SPST		SPST/SPDT	SPST
Contact rating (Resistive Load)		SF: 15A/125VAC C-UL 10A/277VAC TV-5/120VAC SF: 16A/250VAC TUV 15A/24VDC	SFG: 12A/125VAC 10A/277VAC 10A/24VDC	8A/250VAC 5A/30VDC	25A/250VAC 25A/30VDC
Nominal Coil Voltage (V)	DC AC	5, 6, 9, 12, 18, 24, 48, 100 ----		3, 5, 6, 9, 12, 18, 24, 48, 60 ----	3, 5, 6, 9, 12, 15, 18, 24, 48, 60 ----
Coil Power Consumption		5-48V: 0.20W 100V: 0.56W		0.22W	0.4W
PCB Layout (Bottom View)					



Electromagnetic Relay

		GENERAL PURPOSE			
Appearance					
Series classification		ETR GZR	ETR GZ/GZT	ETR GSA	ETR GSZ
Outline(LxWxH)mm		28.8 x 12.7 x 25.5	29.1 x 13.0 x 20.6	24.5 x 13.0 x 25.0	24.5 x 13.0 x 25.0
Weight		17g	13.2g	13.8g	13.6g
Contact Form		SPST/SPDT	SPST/SPDT	DPST	SPST
Contact rating (Resistive Load)		20A/277VAC 20A/30VDC 25A/125VAC TV-10/120VAC 1HP 250VAC	GZ: 20A/120VAC GZT: 16A/250VAC 16A/24VDC TV-8/120VAC	5A/250VAC 5A/30VDC TV-5/120VAC	16A/120VAC 16A/30VDC TV-8/120VAC
Nominal Coil Voltage (V)	DC AC	3, 5, 6, 9, 12, 15, 18, 24, 48 ----	3, 5, 6, 9, 12, 24, 48 ----	3, 5, 6, 9, 12, 24, 48 ----	3, 5, 6, 9, 12, 24, 48 ----
Coil Power Consumption		D Type: 0.72W L Type: 0.53W	D Type: 0.72W L Type: 0.54W	0.54W	0.54W
PCB Layout (Bottom View)					

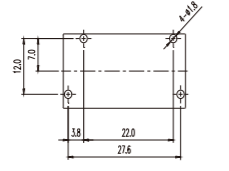
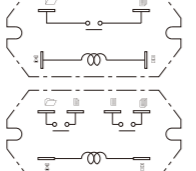
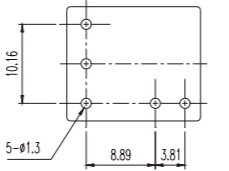
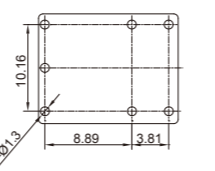

		GENERAL PURPOSE			
Appearance					
Series classification		ETR GU	ETR GU (Quick Contact Tab)		
Outline(LxWxH)mm		32.1 x 27.5 x 20.0	50.0 x 26.9 x 28.2		
Weight		27.2g	34.6g	32.6g	34g
Contact Form		SPST/SPDT	SPST/SPDT		
Contact rating (Resistive Load)		DM: 30A/240VAC 30A/30VDC 30A/120VAC D: 20A/240VAC 20A/30VDC	DM: 30A/240VAC 30A/30VDC	D: 20A/240VAC 20A/30VDC	
Nominal Coil Voltage (V)	DC AC	5, 6, 9, 12, 15, 18, 24, 36, 48, 110 ----	5, 6, 9, 12, 15, 18, 24, 36, 48, 110 ----		
Coil Power Consumption		0.93W	0.93W		
PCB Layout (Bottom View)					

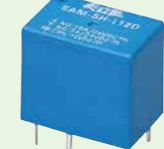

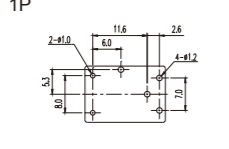
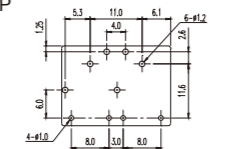
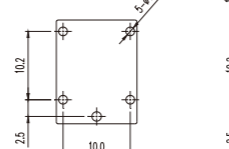
Electromagnetic Relay

	GENERAL PURPOSE		AUTOMOTIVE	
	Appearance			
Series classification	ETR GI	ETR GL	ETR AR/ARW	
Outline(LxWxH)mm	30.2 x 16.2 x 26	67 x 33 x 35	17.2 x 14.8 x 20.2	
Weight	26.6g	90g	10g	
Contact Form	SPST	SPST/DPST	SPST/SPDT	
Contact rating (Resistive Load)	TÜV: 25A/277VAC C-UL: 23A/277VAC	1P: 30A/250VAC 2P: 25A/250VAC 30A/277VAC 25A/277VAC	AR: 3A/120VAC 10A/12VDC	ARW: 5A/120VAC 15A/12VDC
Nominal Coil Voltage (V)	DC	6, 12, 24, 48	6, 9, 12, 24, 48, 60, 100, 110	6,9,12,15,18,24
	AC	----	12, 24, 48, 100~120, 200~240	----
Coil Power Consumption	0.9W	DC Coil: 1.9W AC Coil: 1.7~2.5VA	Standard: 0.93W European: 1.1W	
PCB Layout (Bottom View)				

	AUTOMOTIVE		
	Appearance		
Series classification	ETR SAM	ETR JM	ETR JMW
Outline(LxWxH)mm	1P: 17.2 x 12.1 x 16.2 2P: 17.2 x 23.1 x 16.2	1P: 15.7 x 12.2 x 13.7 / 2P: 15.7 x 24.2 x 13.7	
Weight	8g	15.2g	1P: 5.2g / 2P: 10.2g
Contact Form	SPST/SPDT/DPST/DPDT	SPST/SPDT/DPST/DPDT	SPST/2xSPST
Contact rating (Resistive Load)	1P: N.O. 10A/24VDC N.C. 7A/24VDC	2P: N.O. 15A/15VDC N.C. 10A/15VDC	1P: 20A/14VDC 10A/14VDC 2P: 20A/14VDC 10A/14VDC
Nominal Coil Voltage (V)	DC	5, 6, 9, 12, 18, 24	6, 9, 10, 12, 24
	AC	----	----
Coil Power Consumption	0.45W		D Type: 0.8W L Type: 0.6W
PCB Layout (Bottom View)			

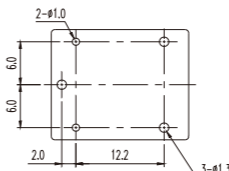
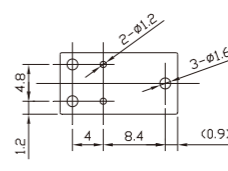
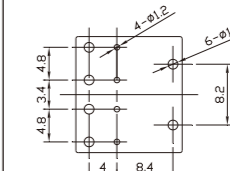
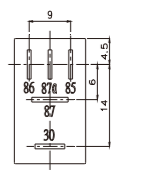
Electromagnetic Relay

	AUTOMOTIVE			
	Appearance			
Series classification	ETR RWM	ETR GIN		ETR ZEM
Outline(LxWxH)mm	19.0 x 15.4 x 15.0	14.2 x 7.3 x 13.6	14.2 x 15.5 x 13.6	21.4x 15.5 x 23.5
Weight	9.0g	4g	9g	20g
Contact Form	SPST/SPDT	SPST/DPST	SPDT/DPDT	SPST/SPDT
Contact rating (Resistive Load)	15A/15VDC	25A/16VDC		NO: 30A/12VDC 15A/24VDC NC: 20A/12VDC 10A/24VDC
Nominal Coil Voltage (V)	DC	9, 12, 24	9, 12, 24, 48	12, 24
	AC	----	----	----
Coil Power Consumption	0.8W	9~24V: 0.64W 48V: 0.8W		D Type: 1.6W L Type: 1.2W
PCB Layout (Bottom View)				

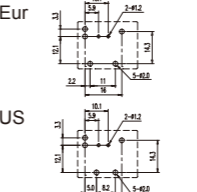
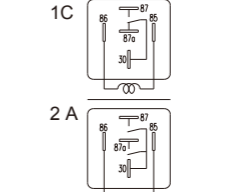
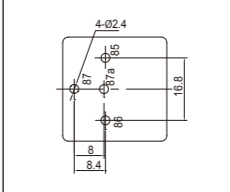
	AUTOMOTIVE		SIGNAL
	Appearance		
Series classification	ETR CAR	ETR GRL	ETR AZ
Outline(LxWxH)mm	23.1 x 18.0 x 19.5	28.0 x 28.0 x 25.0	15.4 x 10.4 x 11.7
Weight	20.2g	36.5g	3.5g
Contact Form	SPST/SPDT	SPST/SPDT/DPST	SPST
Contact rating (Resistive Load)	40A/12VDC(D/DM) 30A/12VDC(L/LM)	1P: N.O.: 40A/12VDC N.C.: 30A/12VDC 2P: 40A(20Ax2)/12VDC	54A/30VDC
Nominal Coil Voltage (V)	DC	6, 12, 24, 36, 48	12, 24
	AC	----	----
Coil Power Consumption	D Type: 1.59~1.89W L Type: 0.6W	1.8W	1.2W
PCB Layout (Bottom View)			

Electromagnetic Relay

		SIGNAL			PLUG IN
Appearance					
Series classification		ETR ST	ETR GS	ETR UA	ETR MRE
Outline(LxWxH)mm		12.6 x 7.8 x 10.0	20.5 x 10 x 11.5	15.4 x 10.4 x 11.7	22.8 x 18.4 x 27.0
Weight		2g	4.8g	3.5g	18g
Contact Form		SPDT	DPDT	SPST/SPDT	DPST/DPDT
Contact rating (Resistive Load)		2A/120VAC 2A/24VDC	1A/120VAC 2A/24VDC	3A/120VAC 3A/24VDC	5A/120VAC 5A/24VDC
Nominal Coil Voltage (V)	DC	3, 5, 6, 9, 12, 24	3, 5, 6, 9, 12, 24, 48	3, 5, 6, 9, 12, 24	6, 9, 12, 24, 48
	AC	----	----	----	----
Coil Power Consumption		D Type: 0.36W T Type: 0.20W L Type: 0.15W	D Type: 0.36W T Type: 0.20W L Type: 0.15W	0.36W	0.9W
PCB Layout (Bottom View)					

		PLUG IN			
Appearance					
Series classification		ETR RE		ETR RK	
Outline(LxWxH)mm		27.6 x 21.1 x 36.0		2P: 34.3 x 34.3 x 53.0	3P: 34.3 x 34.3 x 53.0
Weight		32g	35g	72.6g	81.2g
Contact Form		DPST/DPDT	4PST/4PDT	DPDT/3PDT	
Contact rating (Resistive Load)		5A/250VAC 5A/30VDC	5A/250VAC 5A/30VDC	2P/3P: 10A/240VAC	
Nominal Coil Voltage (V)	DC	6, 12, 24, 48, 60, 110, 120, 220		12, 24, 48, 110, 120	
	AC	6, 12, 24, 48, 110, 120, 220, 240, 230		6, 12, 24, 120, 240	
Coil Power Consumption		DC Coil: 0.9W~1.1W AC Coil: 0.96~2.01VA		DC Coil: 1.5W AC Coil: 1.6~2.41VA	
PCB Layout (Bottom View)					

Electromagnetic Relay

		PLUG IN			
Appearance					
Series classification		ETR RET			
Outline(LxWxH)mm		27.6 x 21.1 x 35		31 x 27.5 x 35.5	41 x 27.5 x 35.5
Weight		35g		53.2g	66.5g
Contact Form		SPST/SPDT	DPST/DPDT	3PST/3PDT	4PST/4PDT
Contact rating (Resistive Load)		15A/250VAC 15A/30VDC	10A/250VAC 10A/30VDC 1/3HP 250VAC	10A/250VAC 10A/30VDC	10A/250VAC 10A/30VDC
Nominal Coil Voltage (V)	DC	6, 12, 24, 48, 60, 110, 120			
	AC	6, 12, 24, 48, 110, 120, 220, 230, 240			
Coil Power Consumption		DC Coil: 0.9W AC Coil: 0.96~2.01VA		DC Coil: 1.4W AC Coil: 1.6~2.0VA (60HZ)	DC Coil: 1.5W AC Coil: 1.95~2.5VA(60HZ)
PCB Layout (Bottom View)					

		PLUG IN			
Appearance					
Series classification		ETR RP		ETR RPT	
Outline(LxWxH)mm		38.0 x 34.5 x 47.6		38.0 x 34.5 x 47.6	
Weight		85g		85g	
Contact Form		DPST/DPDT/3PST/3PDT	SPST/SPDT/DPST/DPDT/3PST/3PDT		
Contact rating (Resistive Load)		10A/240VAC 13A/120VAC 13A/28VDC	1P: 30A/240VAC 30A/28VDC	2P: 25A/240VAC 13A/28VDC	3P: 20A/120VAC 13A/28VDC
Nominal Coil Voltage (V)	DC	12, 24, 48, 110, 120			
	AC	6, 12, 24, 120, 240			
Coil Power Consumption		DC Coil: 1.2W AC Coil: 2.9~4.6VA			
PCB Layout (Bottom View)					

Terminal Block

Products	EUROSTYLE							
Pictures								
Series	ETB01	ETB02	ETB03	ETB05	ETB06	ETB08	ETB09	ETB1A-THT
Features	Clamping type 55 Degree screw in	Wire protector type Strip pin type	Clamping type 55 Degree screw in	Clamping type Double deck	Clamping type	Wire protector type	Wire protector right angle type	Wire protector type
Height (mm)	9.5	10.0	9.7	16.2	8.5	8.2	6.5	10.2
Pitch (mm)	3.5 / 7.0	3.5 / 7.0	3.5 / 7.0	3.5 / 7.0	3.5 / 7.0	3.5 / 7.0	3.5 / 7.0	5.0 / 10.0
Wire range	26~16AWG	28~18AWG	26~16AWG	26~16AWG	26~16AWG	28~18AWG	28~18AWG	22~14AWG
Rated	10A 300VAC	8A 300VAC	10A 300VAC	10A 300VAC	10A 300VAC	10A 125VAC	10A 125VAC	10A 300VAC
Others								









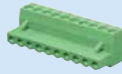

Products	EUROSTYLE							
Pictures								
Series	ETB10	ETB1A-THR	ETB11	ETB12	ETB13	ETB14	ETB15	ETB16
Features	Wire protector type	Wire protector type	Wire protector type	Wire protector right angle type	Clamping type	Clamping type Right angle type	Clamping type 35 Degree screw in	Wire protector type Strip pin type
Height (mm)	10.0	10.2	11.0	8.0	14.0	10.2	15.5	10.8
Pitch (mm)	5.0 / 10.0	5.0 / 10.0	5.0 / 10.0	5.0 / 10.0	5.0 / 10.0	5.0 / 10.0	5.0 / 10.0	5.0 / 10.0
Wire range	24~14AWG	22~14AWG	22~14AWG	22~14AWG	22~12AWG	22~14AWG	22~14AWG	24~14AWG
Rated	16A 300VAC	10A 300VAC	8A 300VAC	8A 300VAC	16A 300VAC	10A 300VAC	10A 300VAC	10A 300VAC
Others								

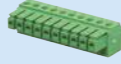





Terminal Block

Products	EUROSTYLE							
Pictures								
Series	ETB18	ETB19	ETB20	ETB21	ETB22	ETB23	ETB30	ETB31
Features	Clamping type Double deck	Clamping type Double deck	Clamping type	Clamping type 55 Degree screw in	Clamping type	Clamping type 3 Deck	Clamping type	Clamping type 55 Degree screw in
Height (mm)	25.2	19.1	10.0	11.0	16.0	28.2	8.5	9.5
Pitch (mm)	5.0 / 10.0	5.0 / 10.0	5.0 / 10.0	5.0 / 10.0	5.0 / 10.0	5.0 / 10.0	3.81 / 7.62	3.81 / 7.62
Wire range	24~14AWG	24~14AWG	22~14AWG	24~14AWG	24~14AWG	24~14AWG	26~16AWG	26~16AWG
Rated	10A 300VAC	10A 300VAC	10A 300VAC	10A 300VAC	10A 300VAC	10A 300VAC	10A 300VAC	10A 300VAC
Others								

Products	EUROSTYLE							
Pictures								
Series	ETB32	ETB33	ETB34	ETB35	ETB36	ETB37	ETB38	ETB3A
Features	Clamping type Double deck	Clamping type	Clamping type	Clamping type Right angle type	Clamping type 55 Degree screw in	Wire protector Type	Clamping type Double deck	Wire protector Type
Height (mm)	16.2	10.0	14.0	10.2	9.5	14.0	19.1	10.0
Pitch (mm)	3.81 / 7.62	5.08 / 10.16	5.08 / 10.16	5.08 / 10.16	3.81 / 7.62	3.81 / 7.62	5.08 / 10.16	5.08 / 10.16
Wire range	26~16AWG	22~14AWG	24~14AWG	24~14AWG	26~16AWG	28~18AWG	24~14AWG	24~14AWG
Rated	10A 300VAC	10A 300VAC	10A 300VAC	10A 300VAC	10A 300VAC	10A 300VAC	10A 300VAC	16A 300VAC
Others								

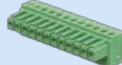







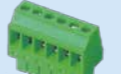

Terminal Block

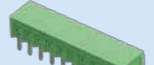
Products	PLUG IN TYPE				
Pictures					
Series	ETB41	ETB42	ETB45	ETB4C	ETB4D
Features	Clamping type Plug type Plug in with ETB43	Clamping type Plug type Mount type Plug in with ETB44	Clamping type Plug type Plug in with ETB47	Screw type Plug type Plug in with ETB43	Screw type Mount type Plug in with ETB44
Height (mm)	15.2	15.2	10.7	15.0	15.0
Pitch (mm)	5.08	5.08	3.81	5.08	5.08
Wire range	24~12AWG	24~12AWG	28~16AWG	24~12AWG	24~12AWG
Rated	10A 300VAC	10A 300VAC	7A 300VAC	12A 300VAC	12A 300VAC
Others					

Products	PLUG IN TYPE				
Pictures					
Series	ETB4E	ETB4F	ETB81	ETB85	ETB86
Features	Clamping type Plug type Plug in with ETB4G	Clamping type Mount type Plug in with ETB4H	Clamping type Plug type Plug in with ETB83/ ETB8R/ ETB8L	Clamping type Plug type Plug in with ETB87	Clamping type Plug type Plug in with ETB88
Height (mm)	31	31	15.2	10.9	10.9
Pitch (mm)	7.62	7.62	5.0	3.5	3.5
Wire range	24~10 AWG	24~10 AWG	24~12AWG	28~16AWG	28~16AWG
Rated	20A 300VAC	20A 300VAC	10A 300VAC	6A 300VAC	6A 300VAC
Others					

Terminal Block

Products	PLUG IN TYPE 				
Pictures					
Series	ETB8E	ETB8R-2P	ETB8R-4P	ETB8L-2P	ETB8L-4P
Features	Clamping type Plug type Plug in with ETB87	Socket type	Socket type	Socket type	Socket type
Height (mm)	19.1	16.5	18.0	16.5	18.0
Pitch (mm)	3.5	5.0	5.0	5.0	5.0
Wire range	28~16AWG	---	---	---	---
Rated	6A 300VAC	16A 300VAC	16A 300VAC	16A 300VAC	16A 300VAC
Others					

Products	PLUG IN TYPE				
Pictures					
Series	ETB43	ETB44	ETB47	ETB4A	ETB4B
Features	Socket type Stackable type	Socket type Mount type	Socket type	Socket type	Socket type Mount type
Height (mm)	8.6 / 12.0	8.6 / 12.0	7.0 / 9.2	7.0 / 9.2	7.0 / 9.2
Pitch (mm)	5.08	5.08	3.81	3.81	3.81
Wire range
Rated	10A 300VAC	10A 300VAC	7A 300VAC	8A 300VAC	8A 300VAC
Others					

Terminal Block

Products	PLUG IN TYPE					
Pictures						
Series	ETB4G	ETB4H	ETB83	ETB84	ETB87	ETB88
Features	Socket type	Socket type Mount type	Socket type Stackable type	Socket type Mount type	Socket type	Socket type Mount type
Height (mm)	29	29	8.6 / 12.0	8.6 / 12.0	7.0 / 9.2	7.0 / 9.2
Pitch (mm)	7.62	7.62	5.0	5.0	3.5	3.5
Wire range
Rated	32A 300VAC	32A 300VAC	10A 300VAC	10A 300VAC	6A 300VAC	6A 300VAC
Others						











Products	SCREWLESS TYPE					
Pictures						
Series	ETB61	ETB62	ETB63	ETB64	ETB 6E	ETB 6F
Features	Plug type Plug in with ETB43	Plug type Mount type Plug in with ETB44	Parallel type	Vertical type	Parallel type	Vertical type
Height (mm)	15.0	15.0	10.0	15.65	12.6	13.6
Pitch (mm)	5.08	5.08	2.54	2.54	2.54	2.54
Wire range	24~14AWG	24~14AWG	28~22AWG	28~22AWG	26~20 AWG	26~20 AWG
Rated	10A 300VAC	10A 300VAC	3A 150VAC	3A 150VAC	6A 150V	6A 150V
Others						









Terminal Block

Products	SCREWLESS TYPE					
Pictures						
Series	ETB6G	ETB6H	ETB65	ETB66	ETB67	ETB68
Features	Plug type Plug in with ETB83	Plug type Plug in with ETB83	Parallel type	Vertical type	Plug type Plug in with ETB4A	Plug type Plug in with ETB4B
Height (mm)	15.0	15.0	12.7	13.6	12.4	12.4
Pitch (mm)	5.0	5.0	5.08	5.08	3.81	3.81
Wire range	24~14AWG	24~14AWG	24~14AWG	24~14AWG	28~16AWG	28~16AWG
Rated	10A 300VAC	10A 300VAC	10A 150VAC	10A 150VAC	8A 300VAC	8A 300VAC
Others						











Products	SCREWLESS TYPE					
Pictures						
Series	ETB69-2P-S	ETB69-2P-L	ETB69-3P-S	ETB6C	ETB6D	ETBM3
Features	Vertical type	Parallel type	Vertical type	Parallel type	Vertical type	45 Degree type
Height (mm)	18.8	12.5	21.0	11.4	14.5	10.0
Pitch (mm)	9.0	9.0	10.0	3.81	3.81	3.5
Wire range	ø1.2MM~ ø2.0 SOLID	ø1.2~2.0mm (Solid)	ø1.2~2.0mm (Solid)	28~16AWG	28~16AWG	16~26AWG
Rated	20A 300VAC	20A 300VAC	20A 300VAC	8A 300VAC	8A 300VAC	5A 300VAC
Others						













Terminal Block

Products	SCREWLESS TYPE					
Pictures						
Series	ETBM37	ETBF60	ETBM50	ETBV50	ETBH50	ETBL40
Features	Screwless type	Parallel type	45 Degree type	Vertical type	Horizontal type	SMD type
Height (mm)	7.5	12	10.0	12.0	12.45	3.8
Pitch (mm)	3.5 / 7.0	7.5	5.0	5.0	5.0	4.0
Wire range	24~18AWG	12~20AWG	26~14 AWG	26~14 AWG	26~14 AWG	24~18 AWG
Rated	5A 300VAC	10A 300VAC	10A 300V	10A 300V	10A 250V	9A 320VAC
Others						

Products	HIGH POWER TYPE			
Pictures				
Series	ETB71	ETB73	ETB74	ETB75
Features	Wire protector type	Clamping type	Clamping type	Clamping type
Height (mm)	13	26	14	14
Pitch (mm)	7.5 / 15.0	9.0 / 18.0	7.5 / 15.0	7.5 / 15.0
Wire range	24~14AWG	24~10AWG	24~12AWG	24~12AWG
Rated	16A 300VAC	35A 300VAC	16A 300VAC	16A 300VAC
Others				

Terminal Block

Products	WIRE TO P.C.B. TYPE				
Pictures					
Series	ETB50 (MOUNT TYPE)	ETB50 (BARRIER TYPE)	ETB51 (MOUNT TYPE)	ETB51 (BARRIER TYPE)	ETB52 (MOUNT TYPE)
Pitch (mm) & Introduction	9.5 (0.374 inch)	9.5 (0.374 inch)	8.25 (0.325 inch)	8.25 (0.325 inch)	8.25 (0.325 inch)
Wire range	14~22AWG	14~22AWG	14~22AWG	14~22AWG	14~22AWG
Rated	15A 300VAC	15A 300VAC	15A 300VAC	15A 300VAC	15A 300VAC
Others					

Products	WIRE TO P.C.B. TYPE					
Pictures						
Series	ETB52 (BARRIER TYPE)	ETB53 (MOUNT TYPE)	ETB53 (BARRIER TYPE)	ETB54 (MOUNT TYPE)	ETB54 (BARRIER TYPE)	ETB 5C (BARRIER TYPE)
Pitch (mm) & Introduction	8.25 (0.325 inch)	10 (0.394 inch)	10 (0.394 inch)	7.62 (0.3 inch)	7.62 (0.3 inch)	7.62 (0.3 inch)
Wire range	14~22AWG	14~22AWG	14~22AWG	16~22AWG	16~22AWG	16~22AWG
Rated	15A 300VAC	20A 300VAC	20A 300VAC	10A 300VAC	10A 300VAC	10A 300VAC
Others						

Terminal Block

Products	WIRE TO P.C.B. TYPE				
Pictures					
Series	ETB55 (MOUNT TYPE)	ETB55 (BARRIER TYPE)	ETB58 (BARRIER TYPE)	ETB56 (MOUNT ENDS WITH COVER TYPE) (DOVETAIL WITH COVER TYPE)	ETB57 (MOUNT ENDS WITH COVER TYPE) (DOVETAIL WITH COVER TYPE)
Pitch (mm) & Introduction	6.35 (0.25 inch)	6.35 (0.25 inch)	7.62 (0.3 inch)	7.62 (0.3 inch)	10.0 (0.394 inch)
Wire range	18~22AWG	18~22AWG	16~22AWG	14~22AWG	12~22AWG
Rated	10A 300VAC	10A 300VAC	10A 300VAC	14A 300VAC	20A 300VAC
Others					





Products	WIRE TO WIRE TYPE NEW					
Pictures						
Series	ETB T14-□P-0K	ETB T14-□P-2K	ETB T14-□P-0S	ETB T14-□P-2F	ETB T14-□P-4K	ETB T14-□P-4F
Pitch (mm)	11.0	11.0	11.0	11.0	11.0	11.0
Wire range	10~18AWG	10~18AWG	10~18AWG	10~18AWG	10~18AWG	10~18AWG
Rated	300V - 30A	300V - 20A	300V - 30A	300V - 20A	300V - 30A	300V - 30A
Others						





Connector

Products	ZIF TYPE BOARD TO FPC	ZIF TYPE BOARD TO FPC SLIDE	ZIF TYPE BOARD TO FPC FLIP-LOCK
Pictures			
Series classification	EFC-PM24	EFC-PT24-S	EFC-PT24-RF
Contact Spacing	1.0mm	0.5mm	0.5mm
No. of positions	xx: 04~34	xx: 04~60	xx: 04~50
Termination Style	SMT/DIP	SMT	SMT
Connection Style	D: ZIF Right Angle Downside Type U: ZIF Right Angle Upside Type V: ZIF Top Entry/ SMT T2: ZIF Top Entry/ DIP	D: ZIF Right Angle Downside Type U: ZIF Right Angle Upside Type V: ZIF Top Entry	D: ZIF Rotary Right Angle, Sunk into PCB, Flip-Lock F: ZIF Rotary Right Angle, on PCB, Flip-Lock
On Board Mated Height (Profile)	H3: 2.7, V/ T2: 5.9mm	H2A: 2.0, V4: 5.9mm	H2: 1.85mm
Applicable FPC Thickness	0.3mm	0.3mm	0.3mm
Options / Others			



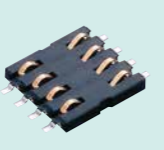

Products	BOARD TO WIRE			
Pictures				
Series	EBW20	EBW-CK22	EBW-PK26	EBW14
Contact Spacing	0.8mm	1.25mm	1.25mm	2.0mm
No. of positions	xx2~22	xx: 2~30	xx: 2~15	xx2~16
Termination	SMT	SMT	SMT	DIP
Connection Style	P_H2: Right Angle Plug S: Socket Housing (Include Terminal)	P: Right Angle Plug S: Socket Housing C/T: Crimp Terminal	P_V5: Straight Plug P_H3: Right Angle Plug S: Socket Housing C/T: Crimp Terminal	P_T: Straight Plug P_L: Right Angle Plug
On Board Mated Height (Profile)	H2: 1.75mm	P_H2C: 2.1mm, H2: 1.76mm	V5: 4.75, H3: 3.45mm	T: 6.2, L: 5mm
Options / Others		AWG: 28/ 30		T2/ L2: 2.6, T3/ L3: 3.3mmL



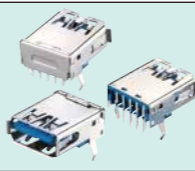
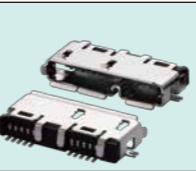

Connector

Products	BOARD TO BOARD			
Pictures				
Series	EBB-PS25	EBB-PR22	EBB-PR24	EBB-PR27
Contact Spacing	0.635mm	0.8mm	0.8mm	0.8mm
No. of positions	xxx: 020~060	xxx: 020~060	xx: 6~36	xxx: 010~030
Termination	SMT	SMT	SMT	SMT
Connection Style	S: Straight Socket P: Straight Plug	S_T: Straight Socket P_T: Straight Plug P_H: Right Angle Plug	S: Straight Socket SA: Straight Socket P_V3: Straight Plug P_H3: Right Angle Plug	S: Straight Socket P: Straight Plug
On Board Mated Height (Profile)	S_V4: 3.2, P_V4: 1.8, V5: 2.8mm	S: Tx:2.85, T5:5, T8:8, T11:11, P: T2:2, T6:6, H4:5.75mm	S_V3: 0.9, P_V3: 3.6, P_H3: 4.75mm	S_V2N: 1.5, P_V2N: 1.5, P_V3N: 2.7, P_V4N: 2.0mm
Options / Others			S: 6~20 pin SA: 22~36 pin	

Products	BATTERY CONNECTORS	SIM CARD CONNECTORS	SPLICING CONNCTOR FOR TELECOMMUNICATION	
Pictures				
Series classification	EIO-CL26-S004Hx	EIO-CL26-S003Vxx	ECC-CL22	ECT
Contact Spacing	2.5mm	6.5mm	2.54mm
No. of positions	xxx: 003, 004, 006	xxx: 003	xx: 006, 008	(Application)--UY:22-26AWG, UB:22-26 or 24-26 AWG, UR:19-26AWG
Termination Style	SMT	SMT	SMT
Connection Style	H: Horizontal (Right Angle)	V: Vertical	Right Angle	ECT UY, UB, UR and MD
On Board Mated Height (Profile)	H3: 4.15mm, H6: 7.65mm, H8: 8.70mm	V10: 10.2, V13: 12.6, V15: 15mm	H3: 2.45mm
Contact Rating			(Dielectric strength): 3.0KV at a 60Hz
Options / Others		

Connector

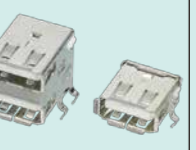
Products	USB 3.0 CONNECTOR	MICRO USB 3.0 CONNECTOR	MICRO USB CONNECTOR		ULTRA MINIATURE USB CONNECTOR
Pictures					
Series classification	ESB23	ESB22712	ESB22A / ESB227	ESB22B / ESB228	ESB38
Contact Spacing	2.0mm	0.65mm	0.65mm	0.65mm	0.45mm
Termination Style	DIP	Hand-Soldering	Hand-Soldering/ SMT	Hand-Soldering/ SMT	SMT
Setting & No. of positions	A Type 9 Pin	10 Pin	5 Pin	5 Pin	8 Pin, SHELL: SMT/ T/H
Connection Style	Right Angle Socket	Micro AB Plug	Micro A Plug Micro B Socket Micro AB Socket	Micro B Plug Micro B Socket	Right Angle Socket
Port Type	Single		Single	Single	Single
On Board Mated Height (Profile)	6.99mm	2.71mm	3.8mm	3mm	2.75mm
Option / Others					USB mini 5 pin + TV output 3 pin

Products	MINI USB CONNECTOR	MINI USB CONNECTOR	MINI USB CONNECTOR	USB CONNECTOR	
Pictures					
Series classification	ESB37	ESB3A	ESB3	ESB01	ESB021
Contact Spacing	0.8mm	0.8mm	0.8mm	2.5mm	2.5mm
Termination Style	DIP	Hand-Soldering	SMT	DIP/SMT	DIP/SMT
Setting & No. of positions	B Type 5 Pin	B Type 5 Pin	A/B Type 4 Pin, B/C Type 5 Pin	A Type 4 Pin	B Type 4 Pin
Connection Style	Straight Socket	Straight Plug	Right Angle Socket	R/A Socket Dip R/A Socket Double Port Dip R/A Socket Sunkinto PCB SMT	Right Angle Socket Straight Socket
Port Type	Single	Single	Single	Single/Double	Single
On Board Mated Height (Profile)	9mm	10.75mm	4.23, 4.5, 4.18mm	7.7, 14.3, 6.2(4.91), 16mm	11.3, 15.7mm
Option / Others	SHELL: T/H	SHELL: SMT/ T/H	SHELL: SMT/ T/H	Shield: With/ Without	Shield: With/ Without

Connector

Products	MACHINE PIN SOCKET			ZIP SOCKET	RECEPTACLES SOCKET
Pictures					
Series	EMS1, 9	EMS2, 9	EMS4, 5	ELK	ERC
Features	SIP type	Dip Type, Row spacing 0.3", 0.4", 0.6", 0.9"	PGA Standard type, PGA PC Form	Zero insertion/ extraction pressure, Row Spacing 0.3", 0.6", 0.3" & 0.6 mixed	Special design to accept ELK socket, Row spacing 0.6"
Pitch (mm)	2.54	2.54	2.54	2.54	2.54
No. of Positions	6-40 pins	6-64 pins	44-177 pins	24, 28, 32, 40, 48	
Contact Rating	1A	1A	1A	50VDC, 100mA	
Dielectric Withstanding Voltage	10VAC			500VDC	
Contact Resistance	10mΩ Max.			30mΩ Max.	
Insulation Resistance	10 ⁶ MΩ Min.			100MΩ Min.	
Dimensions unit: mm(inch)					

Connector

Products	DC POWER JACK		PHONE JACK			
Pictures						
Series	EPJ3 (ø2.5mm)	EPJ3 (ø0.65mm)	EPJ035	EPJ015	EPJ025	
Features	Through hole type, ø2.5mm	SMT type, ø0.65mm, low profile	SMT type, ø3.5mm	SMT type, ø1.5mm	SMT type, ø2.5mm	SMT type, ø2.5mm
No. of positions	Model: 246S	Model: 245S	8	3	3	4
Contact rating	4A, 20VDC	2A, 5VDC	1A, 12VDC	1A, 12VDC	1A, 12VDC	1A, 12VDC
Insulation Resistance	100MΩ Min.	100MΩ Min.	100MΩ Min.	100MΩ Min.	100MΩ Min.	100MΩ Min.
Others	DC Power Plug is also available. 	DC Power Plug is also available. 	Phone Plug is also available. 	Phone Plug is also available. 		

Products	PHONE JACK		
Pictures			
Series	EPJ025		
Features	SMT type, ø2.5mm	SMT type, ø2.5mm	SMT type, ø2.5mm
No. of positions	5	6	8
Contact rating	1A, 12VDC	1A, 12VDC	1A, 12VDC
Insulation Resistance	100MΩ Min.	100MΩ Min.	100MΩ Min.
Others	Phone Plug is also available. 		

Resettable Fuse (ERF Series)

Pictures	MARKING REFERENCE						
	FX/FU	LX/LU	EX/EU	FT	RA/RN	RB	BX/BU
Model	FX/FU	LX/LU	EX/EU	FT	RA/RN	RB	BX/BU
Voltage	16V/30V	240V _{AC/DC}	120V _{AC/DC}	36V	RA:60V RN:90V	30V	16V/30V
Current	0.5A~15A	50mA~2.0A	0.1A~3.75A	0.5A~2.5A	50mA~3.75A	0.9A-9A	0.75A-2.5A
Form factor	radial leaded	radial leaded	radial leaded	radial leaded	radial leaded	radial leaded	radial leaded
Applications	Wide variety of electronic equipment	Power Supply/ Power Transformer/ 240VDC/AC equipment	Transformer & appliances product	Computer & Consumer electronics	computer & electronic equipment		

Pictures	MARKING REFERENCE								
	RG	HX/HU	AN	LN	TN	RLN	AD	SL/SD/SM SN/SR/SS	RSD/RSM RSN/RSR/RSS
Model	RG	HX/HU	AN	LN	TN	RLN	AD	SL/SD/SM SN/SR/SS	RSD/RSM RSN/RSR/RSS
Voltage	16V	100V/250V /600V	15V/ 30V	15V/ 20V	24V	6V	-----	6-60V	6-9V
Current	2.5A-14A	0.08A- 0.18A	1.2A- 4.2A	1.9A- 7.3A	0.7A- 3.4A	1.4A- 4.5A	-----	0.05A- 5A	0.25A- 3.7A
Form factor	radial leaded	radial leaded	axial leaded	axial leaded	axial leaded	axial leaded	annuls disk	surface mount	surface mount
Applications	electronics, automotive & appliance	telecom equipment	rechargeable battery & packs	rechargeable battery & packs	rechargeable battery & packs (preferred for NiMH chemistry batteries)	rechargeable battery & packs	battery cell charger/ custom design	Computers & peripherals	Computers & peripherals



KENSINGTON
ELECTRONICS inc.
Not just products - Solutions!

INTERNATIONAL,
ALASKA & HAWAII
Please contact one of the ISRs.

Courtney Darrah
Inside Sales Representative
cdarrah@keiconn.com
512-339-3324

Daegan Richmond
Inside Sales Representative
drichmond@keiconn.com
512-339-3331

Kevin Kientopf
Inside Sales Representative
kkientopf@keiconn.com
512-339-3315

Gabby Bozeman
Inside Sales Representative
gbozeman@keiconn.com
512-339-3325

John Davis
Inside Sales Representative
jdavis@keiconn.com
512-339-3311



Scott Kirchmeier
Regional Sales Manager
sales@keiconn.com
512-339-3312

Kevin Kientopf
Inside Sales Representative
kkientopf@keiconn.com
512-339-3315

Courtney Darrah
Inside Sales Representative
cdarrah@keiconn.com
512-339-3324

Gabby Bozeman
Inside Sales Representative
gbozeman@keiconn.com
512-339-3325

Open
Regional Sales Manager
sales@keiconn.com
512-339-3300

Open
Regional Sales Manager
sales@keiconn.com
512-339-3324

Daegan Richmond
Inside Sales Representative
drichmond@keiconn.com
512-339-3331

David Pearson
Regional Sales Manager
sales@keiconn.com
512-339-3316

Open
Regional Sales Manager
sales@keiconn.com
512-339-3300

John Davis
Inside Sales Representative
jdavis@keiconn.com
512-339-3311